

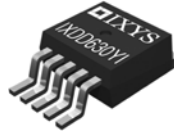

**THE DATASHEET OF  
IXDI630MCI**





### Features

- 30A Peak Source/Sink Drive Current
- High Operating Voltage Capability: 35V
- -40°C to +125°C Extended Operating Temperature Range
- Under-Voltage Lockout Protection
- Logic Input Withstands Negative Swing of up to 5V
- Fast Rise and Fall Times: < 20ns
- Low Propagation Delay Time
- Low 10µA Supply Current
- Low Output Impedance

### Applications

- Efficient Power MOSFET and IGBT Switching
- Switch Mode Power Supplies
- Motor Controls
- DC to DC Converters
- Class-D Switching Amplifiers
- Pulse Transformer Driver



### Description

The IXDD630/IXDI630/IXDN630 high-speed gate drivers are especially well suited for driving the latest IXYS power MOSFETs and IGBTs. The IXD\_630 output can source and sink 30A of peak current while producing voltage rise and fall times of less than 20ns. Internal circuitry eliminates cross conduction and current "shoot-through," and the driver is virtually immune to latch up. Under-voltage lockout (UVLO) circuitry holds the output LOW until sufficient supply voltage is applied (12.5V for the IXD\_630 versions, and 9V for the IXD\_630M versions). Low propagation delays and fast, matched rise and fall times make the IXD\_630 family ideal for very high frequency and high-power applications.

The IXDD630 is configured as a non-inverting driver with an enable. The IXDN630 is configured as a non-inverting driver, and the IXDI630 is configured as an inverting driver.

The IXD\_630 family is available in a 5-pin TO-220 (CI), and a 5-pin TO-263 (YI) package.

### Ordering Information

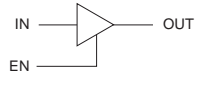
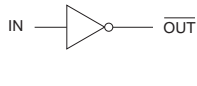
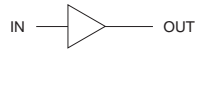
Part Number	Logic Configuration	UVLO	Package Type	Packing Method	Quantity
IXDD630CI		12.5V	5-Pin TO-220	Tube	50
IXDD630MCI		9V	5-Pin TO-220	Tube	50
IXDD630YI		12.5V	5-Pin TO-263	Tube	50
IXDD630MYI		9V	5-Pin TO-263	Tube	50
IXDI630CI		12.5V	5-Pin TO-220	Tube	50
IXDI630MCI		9V	5-Pin TO-220	Tube	50
IXDI630YI		12.5V	5-Pin TO-263	Tube	50
IXDI630MYI		9V	5-Pin TO-263	Tube	50
IXDN630CI		12.5V	5-Pin TO-220	Tube	50
IXDN630MCI		9V	5-Pin TO-220	Tube	50
IXDN630YI		12.5V	5-Pin TO-263	Tube	50
IXDN630MYI		9V	5-Pin TO-263	Tube	50

<b>1. Specifications</b> .....	<b>3</b>
1.1 Lead Configurations .....	3
1.2 Lead Definitions .....	3
1.3 Absolute Maximum Ratings .....	3
1.4 Recommended Operating Conditions .....	4
1.5 Electrical Characteristics: $T_A = 25^{\circ}\text{C}$ .....	4
1.6 Electrical Characteristics: $T_A = -40^{\circ}\text{C}$ to $+125^{\circ}\text{C}$ .....	5
1.7 Thermal Characteristics .....	5
<b>2. Functional Description</b> .....	<b>6</b>
2.1 IXDD630 Block Diagram & Truth Table .....	6
2.2 IXDI630 Block Diagram & Truth Table .....	6
2.3 IXDN630 Block Diagram & Truth Table .....	6
<b>3. Typical Performance Characteristics</b> .....	<b>7</b>
<b>4. Manufacturing Information</b> .....	<b>10</b>
4.1 Moisture Sensitivity .....	10
4.2 ESD Sensitivity .....	10
4.3 Reflow Profile .....	10
4.4 Board Wash .....	10
4.5 Mechanical Dimensions .....	11

# 1 Specifications

## 1.1 Lead Configurations

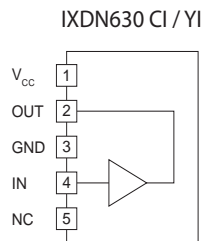
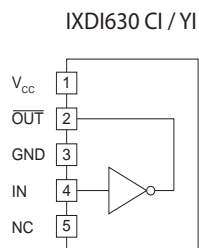
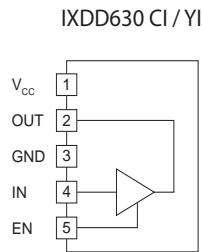

## 1.2 Lead Definitions

Lead Name	Description
IN	Logic Input
EN	Output Enable - Drive lead low to disable output, and force output to a high impedance state
OUT	Output - Sources or sinks current to turn-on or turn-off a discrete MOSFET or IGBT
$\overline{\text{OUT}}$	Inverted Output - Sources or sinks current to turn-on or turn-off a discrete MOSFET or IGBT
V <sub>CC</sub>	Supply Voltage - Provides power to the device
GND	Ground - Common ground reference for the device
NC	Not connected

## 1.3 Absolute Maximum Ratings

Parameter	Symbol	Minimum	Maximum	Units
Supply Voltage	V <sub>CC</sub>	-0.3	40	V
Input Voltage Range	V <sub>IN</sub> , V <sub>EN</sub>	-5	V <sub>CC</sub> +0.3	V
Output Current	I <sub>OUT</sub>	-	±30	A
Junction Temperature	T <sub>J</sub>	-55	+150	°C
Storage Temperature	T <sub>STG</sub>	-65	+150	°C

Unless stated otherwise, absolute maximum electrical ratings are at 25°C

*Absolute maximum ratings are stress ratings. Stresses in excess of these ratings can cause permanent damage to the device. Functional operation of the device at conditions beyond those indicated in the operational sections of this data sheet is not implied.*

**1.4 Recommended Operating Conditions**

Parameter	Symbol	Range	Units
Supply Voltage	$V_{CC}$	UVLO to 35	V
Operating Temperature Range	$T_A$	-40 to +125	°C

**1.5 Electrical Characteristics:  $T_A = 25^\circ\text{C}$** 

 Test Conditions:  $UVLO \leq V_{CC} \leq 35\text{V}$  (unless otherwise noted).

Parameter	Conditions	Symbol	Minimum	Typical	Maximum	Units
Input Voltage, High	$UVLO \leq V_{CC} \leq 18\text{V}$	$V_{IH}$	3.5	-	-	V
Input Voltage, Low	$UVLO \leq V_{CC} \leq 18\text{V}$	$V_{IL}$	-	-	0.8	
Input Current	$0\text{V} \leq V_{IN} \leq V_{CC}$	$I_{IN}$	-	-	$\pm 10$	$\mu\text{A}$
EN Input Voltage, High	IXDD630 only	$V_{ENH}$	$2/3V_{CC}$	-	-	V
EN Input Voltage, Low	IXDD630 only	$V_{ENL}$	-	-	$1/3V_{CC}$	
Output Voltage, High	-	$V_{OH}$	$V_{CC}-0.025$	-	-	V
Output Voltage, Low	-	$V_{OL}$	-	-	0.025	
Output Resistance, High State	$V_{CC}=18\text{V}, I_{OUT}=-100\text{mA}$	$R_{OH}$	-	0.17	0.4	$\Omega$
Output Resistance, Low State	$V_{CC}=18\text{V}, I_{OUT}=100\text{mA}$	$R_{OL}$	-	0.16	0.3	
Output Current, Continuous	Limited by package power dissipation	$I_{DC}$	-	-	$\pm 8$	A
Rise Time	$C_{LOAD}=5.6\text{nF}, V_{CC}=18\text{V}$	$t_r$	-	11	20	ns
Fall Time	$C_{LOAD}=5.6\text{nF}, V_{CC}=18\text{V}$	$t_f$	-	11	18	
On-Time Propagation Delay	$C_{LOAD}=5.6\text{nF}, V_{CC}=18\text{V}$	$t_{ondly}$	-	46	65	
Off-Time Propagation Delay	$C_{LOAD}=5.6\text{nF}, V_{CC}=18\text{V}$	$t_{offdly}$	-	46	65	
Output Enable Time	IXDD630 only	$t_{PZL}, t_{PZH}$	-	34	65	
Output Disable Time	IXDD630 only	$t_{PLZ}, t_{PHZ}$	-	65	125	
Enable Pull-Up Resistor	IXDD630 only	$R_{EN}$	-	400	-	$\text{k}\Omega$
Power Supply Current	$V_{CC}=18\text{V}, V_{IN}=3.5\text{V}$	$I_{CC}$	-	2.5	4	mA
	$V_{CC}=18\text{V}, V_{IN}=0\text{V}$		-	-	0.75	
	$V_{CC}=18\text{V}, V_{IN}=V_{CC}$		-	-	0.75	mA
Under-Voltage Lockout Threshold	$V_{CC}$ Rising, IXD_630M	UVLO	7	9	9.9	
	$V_{CC}$ Rising, IXD_630		10	12.5	13.5	
Under-Voltage Lockout Hysteresis	IXD_630M	-	-	1	-	V
	IXD_630		-	-	1.5	

**1.6 Electrical Characteristics:  $T_A = -40^{\circ}\text{C}$  to  $+125^{\circ}\text{C}$** 

 Test Conditions:  $UVLO \leq V_{CC} \leq 35\text{V}$ ,  $T_J < 150^{\circ}\text{C}$ .

Parameter	Conditions	Symbol	Minimum	Maximum	Units
Input Voltage, High	$UVLO \leq V_{CC} \leq 18\text{V}$	$V_{IH}$	4	-	V
Input Voltage, Low	$UVLO \leq V_{CC} \leq 18\text{V}$	$V_{IL}$	-	0.8	
Output Resistance, High State	$V_{CC}=18\text{V}$ , $I_{OUT}=-100\text{mA}$	$R_{OH}$	-	0.6	$\Omega$
Output Resistance, Low State	$V_{CC}=18\text{V}$ , $I_{OUT}=100\text{mA}$	$R_{OL}$	-	0.45	
Rise Time	$C_{LOAD}=5.6\text{nF}$ , $V_{CC}=18\text{V}$	$t_r$	-	35	ns
Fall Time	$C_{LOAD}=5.6\text{nF}$ , $V_{CC}=18\text{V}$	$t_f$	-	35	
On-Time Propagation Delay	$C_{LOAD}=5.6\text{nF}$ , $V_{CC}=18\text{V}$	$t_{ondly}$	-	100	
Off-Time Propagation Delay	$C_{LOAD}=5.6\text{nF}$ , $V_{CC}=18\text{V}$	$t_{offdly}$	-	100	

**1.7 Thermal Characteristics**

Package	Parameter	Symbol	Rating	Units
IXD_630CI (5-Lead TO-220)	Thermal Impedance, Junction-to-Ambient	$\theta_{JA}$	36	$^{\circ}\text{C/W}$
IXD_630YI (5-Lead TO-263)			46	
IXD_630CI (5-Lead TO-220)	Thermal Impedance, Junction-to-Case	$\theta_{JC}$	3	$^{\circ}\text{C/W}$
IXD_630YI (5-Lead TO-263)			2	

## 2 Functional Description

### 2.1 IXDD630 Block Diagram & Truth Table

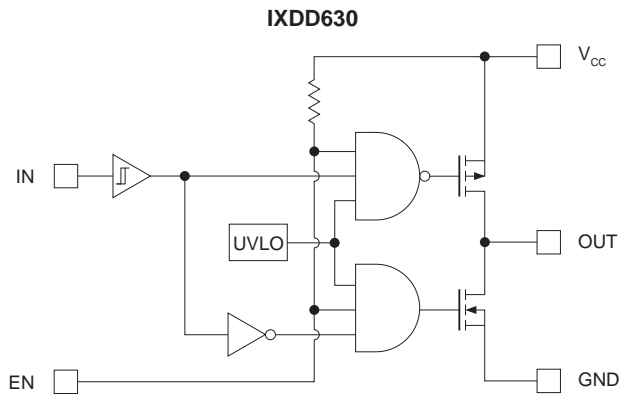

IN	EN	OUT
0	1 or open	0
1	1 or open	1
0	0	Z
1	0	Z

### 2.3 IXDN630 Block Diagram & Truth Table

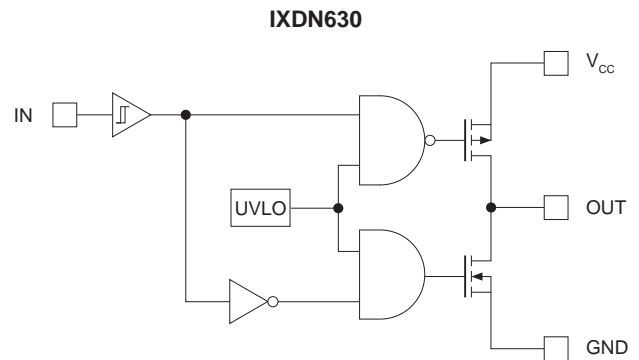

IN	OUT
0	0
1	1

### 2.2 IXDI630 Block Diagram & Truth Table

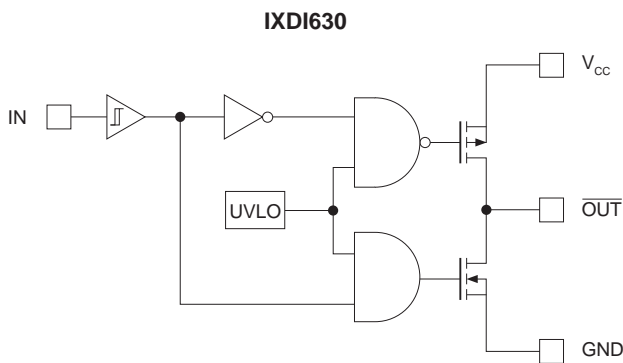

IN	$\overline{\text{OUT}}$
0	1
1	0

### 3 Typical Performance Characteristics

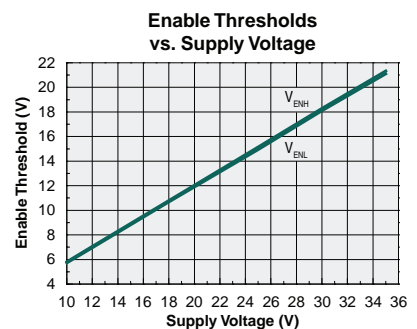
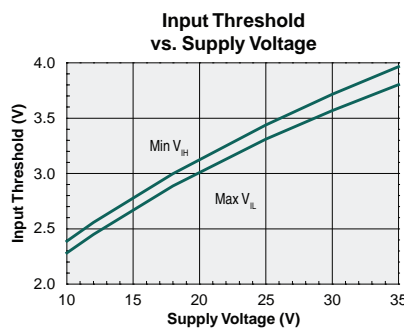
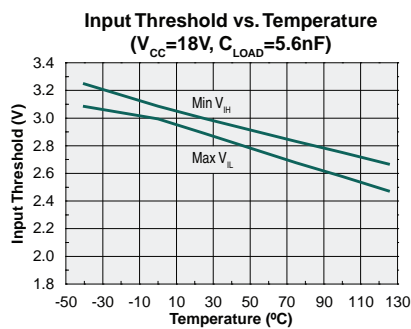
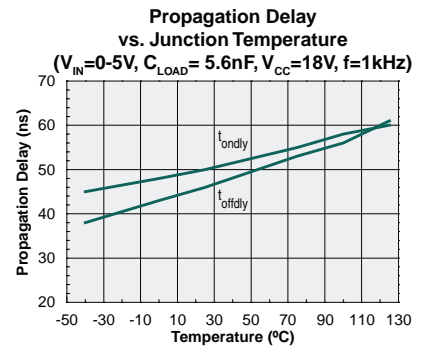
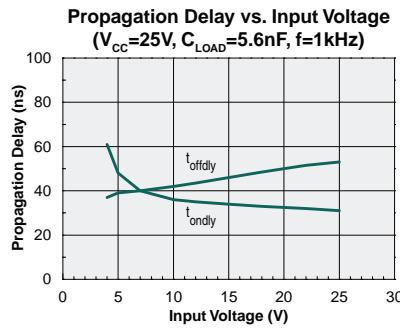
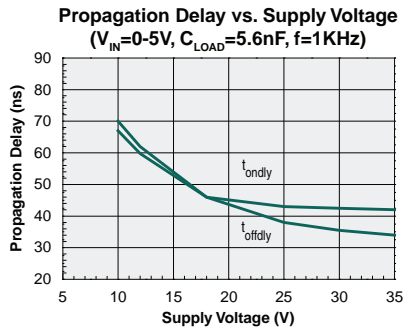
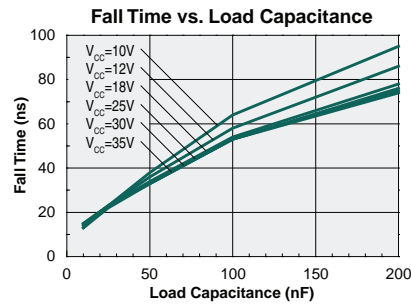
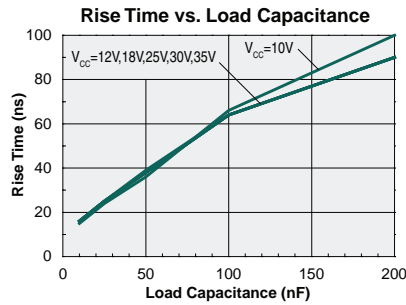
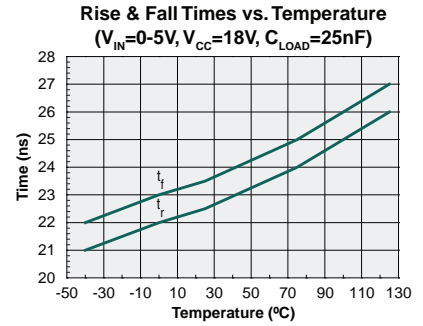
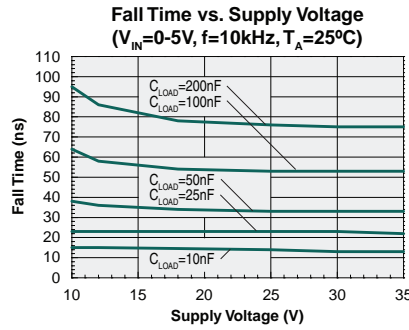
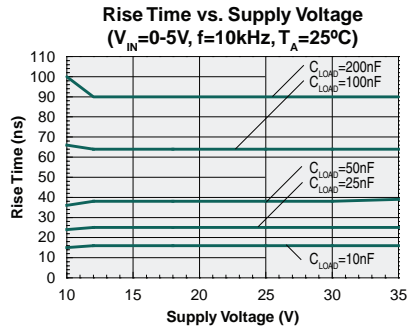

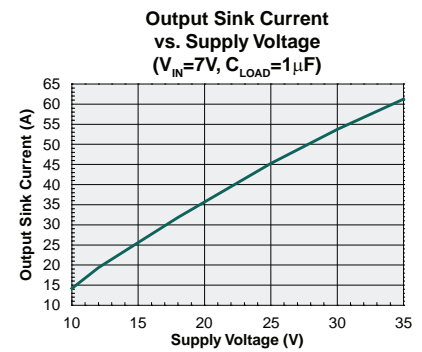
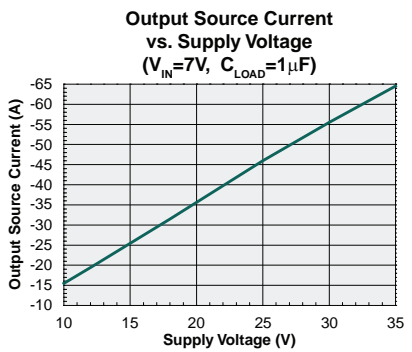
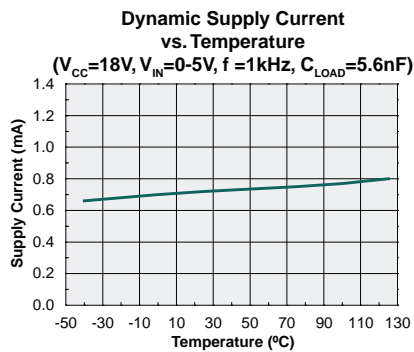
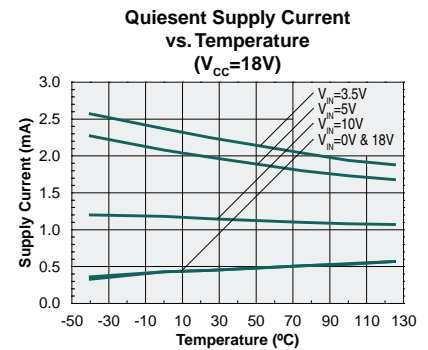
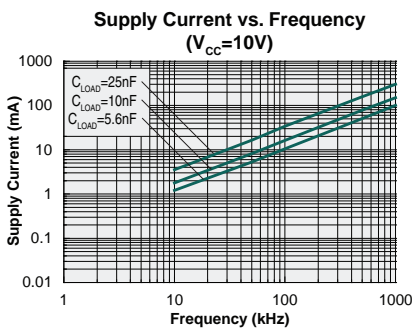
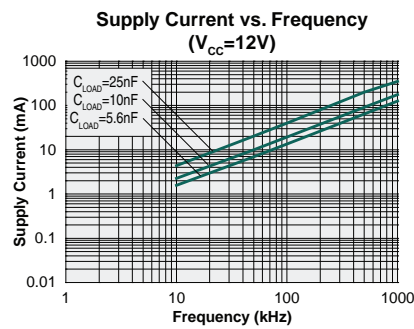
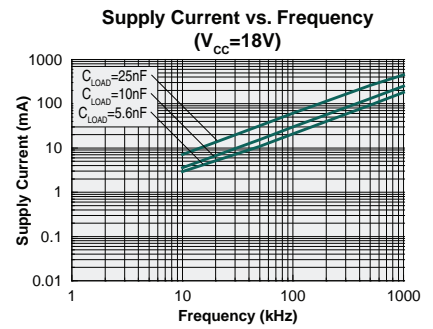
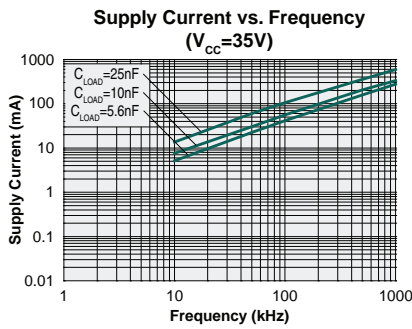
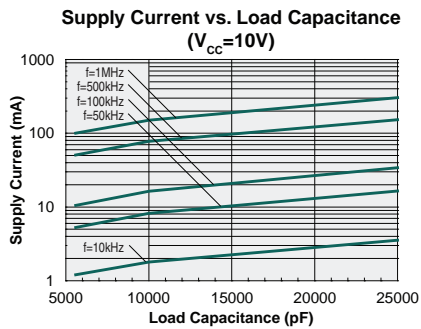
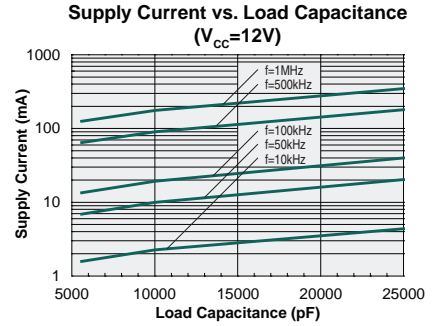
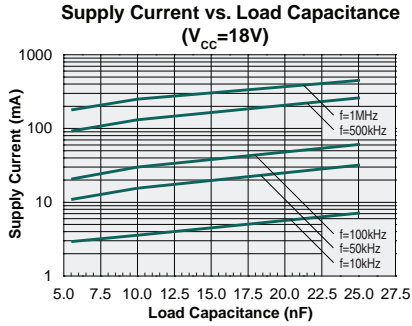
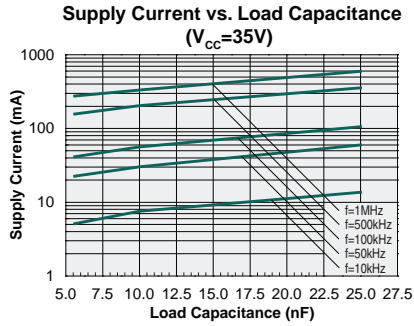

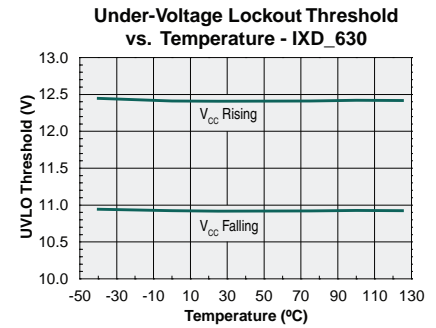
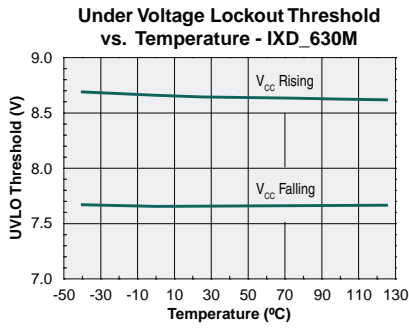
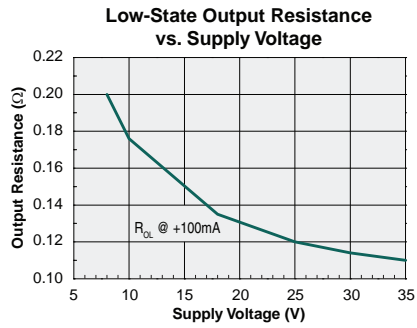
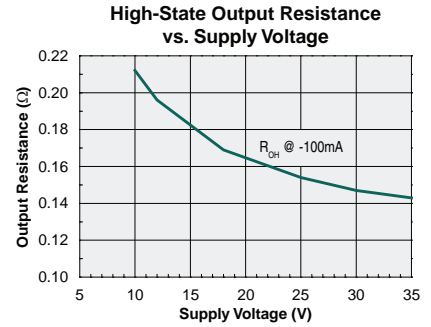
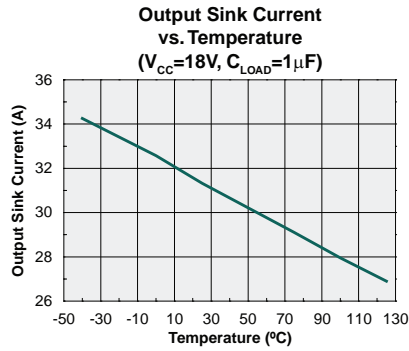
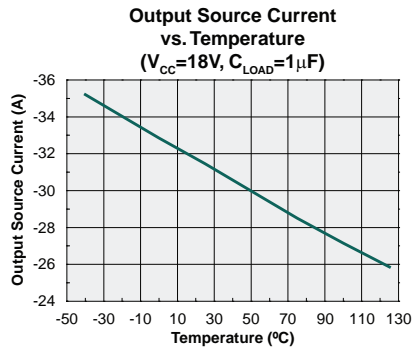

## 4 Manufacturing Information

### 4.1 Moisture Sensitivity



All plastic encapsulated semiconductor packages are susceptible to moisture ingress. IXYS Integrated Circuits Division classifies its plastic encapsulated devices for moisture sensitivity according to the latest version of the joint industry standard, **IPC/JEDEC J-STD-020**, in force at the time of product evaluation.

We test all of our products to the maximum conditions set forth in the standard, and guarantee proper operation of our devices when handled according to the limitations and information in that standard as well as to any limitations set forth in the information or standards referenced below.

Failure to adhere to the warnings or limitations as established by the listed specifications could result in reduced product performance, reduction of operable life, and/or reduction of overall reliability.

This product carries a **Moisture Sensitivity Level (MSL)** classification as shown below, and should be handled according to the requirements of the latest version of the joint industry standard **IPC/JEDEC J-STD-033**.

Device	Moisture Sensitivity Level (MSL) Classification
IXD_630YI / IXD_630MYI	MSL 3
IXD_630CI / IXD_630MCI	MSL 1

### 4.2 ESD Sensitivity



This product is **ESD Sensitive**, and should be handled according to the industry standard **JESD-625**.

### 4.3 Reflow Profile

Provided in the table below is the Classification Temperature ( $T_C$ ) of this product and the maximum dwell time the body temperature of this device may be ( $T_C - 5$ )°C or greater. The classification temperature sets the Maximum Body Temperature allowed for this device during lead-free reflow processes. For through-hole devices, and any other processes, the guidelines of J-STD-020 must be observed.

Device	Classification Temperature ( $T_C$ )	Dwell Time ( $t_p$ )	Max Reflow Cycles
IXD_630YI / IXD_630MYI	245°C	30 seconds	3
IXD_630CI / IXD_630MCI	245°C	30 seconds	1

### 4.4 Board Wash

IXYS Integrated Circuits Division recommends the use of no-clean flux formulations. Board washing to reduce or remove flux residue following the solder reflow process is acceptable provided proper precautions are taken to prevent damage to the device. These precautions include but are not limited to: using a low pressure wash and providing a follow up bake cycle sufficient to remove any moisture trapped within the device due to the washing process. Due to the variability of the wash parameters used to clean the board, determination of the bake temperature and duration necessary to remove the moisture trapped within the package is the responsibility of the user (assembler). Cleaning or drying methods that employ ultrasonic energy may damage the device and should not be used. Additionally, the device must not be exposed to flux or solvents that are Chlorine- or Fluorine-based.



## 4.5 Mechanical Dimensions

### 4.5.1 IXD\_630YI & IXD\_630MYI (5-Lead TO-263)

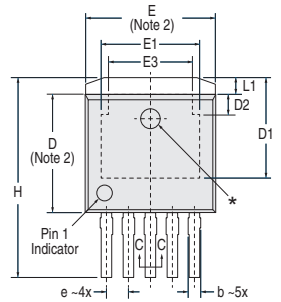

SYMBOL	MM		INCH	
	MIN	MAX	MIN	MAX
A	4.064	4.826	0.160	0.190
A1	0.000	0.254	0.000	0.010
b	0.508	0.991	0.020	0.039
b1	0.508	0.889	0.020	0.035
c	0.381	0.737	0.015	0.029
c1	0.381	0.584	0.015	0.023
c2	1.143	1.651	0.045	0.065
D	8.382	9.652	0.330	0.380
D1	6.858	7.700	0.270	0.303
D2	1.358	1.562	0.053	0.062
E	9.652	10.668	0.380	0.420
E1	6.223	8.000	0.245	0.315
E3	5.092	6.869	0.200	0.270
e	1.702 BSC		0.067 BSC	
H	14.605	15.875	0.575	0.625
L	1.778	2.794	0.070	0.110
L1	1.000	1.676	0.039	0.066
L3	0.254 BSC		0.010 BSC	
R	0.460 TYP		0.018 TYP	
R1	0.506 TYP		0.02 TYP	
θ	-	8°	-	8°

#### Recommended PCB Pattern

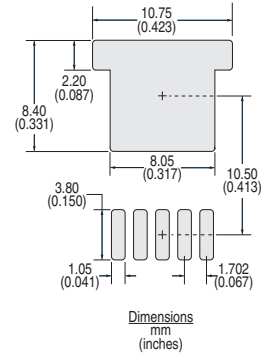

\* Circular feature will be present on devices with the Optional Tip Lead Form.

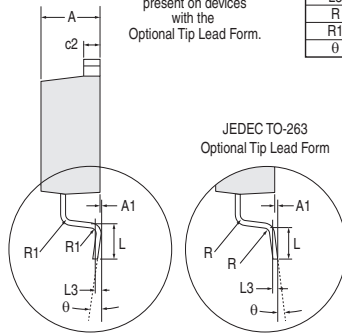

#### NOTES:

1. Reference JEDEC TO-263 Type "BA".
2. Dimension does not include mold flash; mold flash shall not exceed 0.127mm (0.005 inch) per side.
3. Minimum plating: 1000 microinches.
4. Controlling dimension: millimeters.

### 4.5.2 IXD\_630CI & IXD\_630MCI(5-Lead TO-220)

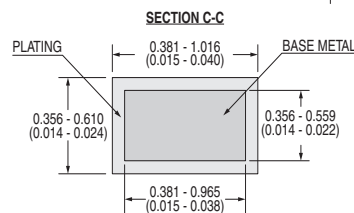
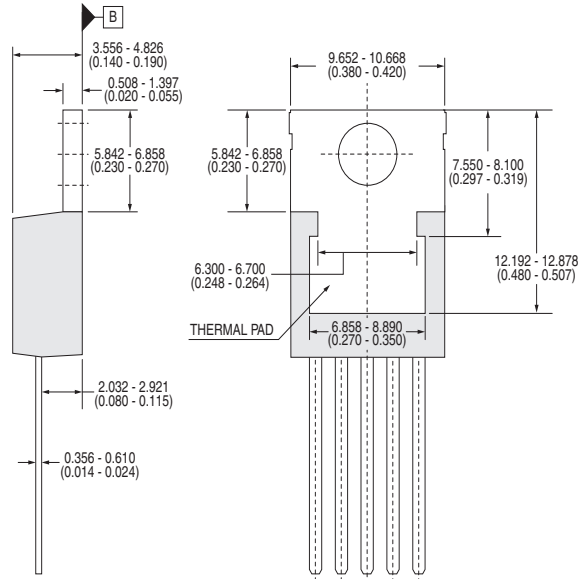
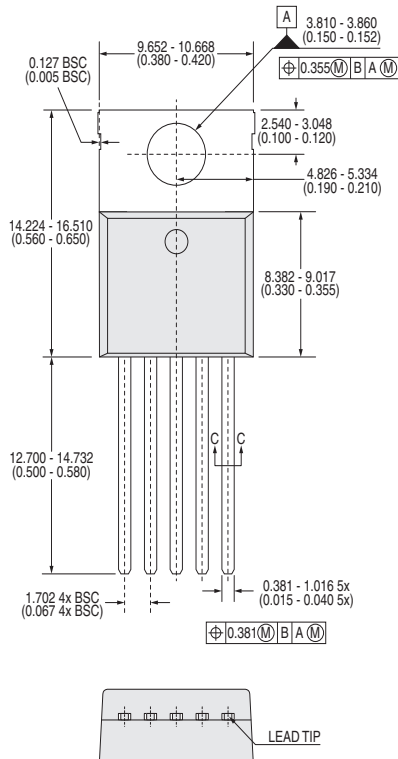

Dimensions  
mm  
(inches)

**For additional information please visit our website at: [www.ixysic.com](http://www.ixysic.com)**

IXYS Integrated Circuits Division makes no representations or warranties with respect to the accuracy or completeness of the contents of this publication and reserves the right to make changes to specifications and product descriptions at any time without notice. Neither circuit patent licenses nor indemnity are expressed or implied. Except as set forth in IXYS Integrated Circuits Division's Standard Terms and Conditions of Sale, IXYS Integrated Circuits Division assumes no liability whatsoever, and disclaims any express or implied warranty, relating to its products including, but not limited to, the implied warranty of merchantability, fitness for a particular purpose, or infringement of any intellectual property right.

The products described in this document are not designed, intended, authorized or warranted for use as components in systems intended for surgical implant into the body, or in other applications intended to support or sustain life, or where malfunction of IXYS Integrated Circuits Division's product may result in direct physical harm, injury, or death to a person or severe property or environmental damage. IXYS Integrated Circuits Division reserves the right to discontinue or make changes to its products at any time without notice.

Specification: DS-IXD\_630-R04  
©Copyright 2017, IXYS Integrated Circuits Division  
All rights reserved. Printed in USA.  
4/5/2017

## Looking for pricing, stock, or lifecycle information?

Click below to explore more details on WIN SOURCE:

 [View IXDI630MCI on WIN SOURCE](#)

 [IXYS Information](#)

## Optimize Your Supply Chain with WIN SOURCE Solutions

-  Global Sourcing Solution
-  Obsolete Management
-  Cost Control Management
-  Shortage Management
-  Alternative Solution
-  Excess Inventory Management