

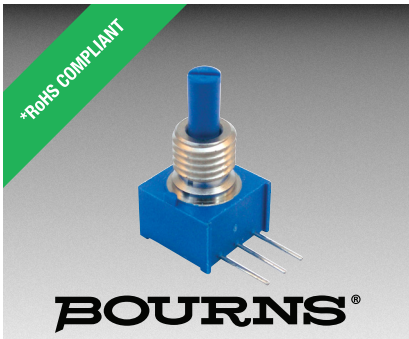

THE DATASHEET OF
3310P-125-103L





Features

- Conductive plastic
- PC board and bushing mount
- Plastic bushing and plastic shaft
- Withstands typical industrial washing processes
- Compact package saves board and panel space

Additional Information

Click these links for more information:



PRODUCT
SELECTOR



TECHNICAL
LIBRARY



INVENTORY



SAMPLES



CONTACT

3310 – 9 mm Square Sealed Panel Control

Electrical Characteristics¹

Standard Resistance Range - Linear	1 K ohms to 1 megohm
Total Resistance Tolerance - Linear Tapers	±20 %
Independent Linearity	±5 %
End Resistance	2 % or 2 ohms maximum (whichever is greater)
Effective Electrical Angle	270 ° ±15 °
Contact Resistance Variation	1 % or 1 ohm (whichever is greater)
Dielectric Withstanding Voltage (MIL-STD-202 – Method 301)	
Sea Level	900 VAC minimum
70,000 Feet	350 VAC minimum
Insulation Resistance	1,000 megohms minimum
Power Rating @ 70 °C (Derate to 0 at 125 °C - Voltage Limited By Power Dissipation or 200 VAC, Whichever is Less)	0.25 watts
Theoretical Resolution	Essentially infinite

Environmental Characteristics

Operating Temperature Range	-40 °C to +125 °C (-40 °F to +257 °F)
Storage Temperature Range	-55 °C to +125 °C (-67 °F to +257 °F)
Temperature Coefficient Over Storage Temperature Range	±1,000 ppm/°C
Vibration	30 G
Total Resistance Shift	±1 % maximum
Voltage Ratio Shift	±1 % maximum
Shock	100 G
Total Resistance Shift	±1 % maximum
Voltage Ratio Shift	±1 % maximum
Load Life	1,000 hours
Total Resistance Shift	±10 % TRS maximum
Rotational Life (No Load)	50,000 cycles
Total Resistance Shift	±5 % TRS maximum
Contact Resistance Variation	3 % or 3 ohms (whichever is greater)
Moisture Resistance	MIL-STD-202, Method 103, Condition B
Total Resistance Shift	±10 % TRS maximum
IP Rating	IP67
Moisture Sensitivity Level	1
ESD Classification (HBM)	N/A

Mechanical Characteristics

Stop Strength	5.65 N-cm (8 oz.-in.)
Mechanical Angle	295 ° ±10 °
Torque	
Starting	3.53 N-cm (5.0 oz.-in.) maximum
Running	3.53 N-cm (5.0 oz.-in.) maximum
Mounting (Torque on Bushing)	45 N-cm (4.0 lb.-in.) max [plastic bushing]; 79 N-cm (7.0 lb.-in.) max [metal bushing]
Weight (Single Section)	4.5 grams
(Each Additional Section)	2.5 grams
Terminals	Solderable pins
Soldering Condition	
Manual Soldering	96.5Sn/3.0Ag/0.5Cu solid wire or no-clean rosin cored wire; 370 °C (700 °F) max. for 3 seconds
Wave Soldering	96.5Sn/3.0Ag/0.5Cu solder with no-clean flux; 260 °C (500 °F) max. for 5 seconds
Wash Processes	For recommended wash processes, please refer to http://www.bourns.com/pdfs/sldclen.pdf
Marking	Manufacturer's trademark, model number, product code, terminal style, resistance code and date code
Ganging	2 cups maximum
Hardware	One lockwasher (H-37-5) and one mounting nut (H-38-1) is shipped with each potentiometer, except bushingless versions
Flammability	Conforms to UL94V-0
Epoxy	Conforms to UL 94V-1
IP Rating	IP67

Switch Characteristics

Switch Life	10K cycles
Contact Resistance	2 ohms max.
Dielectric Strength	350 VDC
Detent Torque	0.5 oz-in min.
Power Rating (Resistive Load)	100 mA @ 16 VDC

¹Electrical specifications tested at 60 RPM, at room ambient: +25 °C nominal.



WARNING
Cancer and Reproductive Harm
www.P65Warnings.ca.gov

*RoHS Directive 2015/863, Mar 31, 2015 and Annex.

Specifications are subject to change without notice. Users should verify actual device performance in their specific applications. The products described herein and this document are subject to specific legal disclaimers as set forth on the last page of this document, and at www.bourns.com/docs/legal/disclaimer.pdf.

Additional Features

- Audio taper versions available as special order
- RoHS compliant*

3310 – 9 mm Square Sealed Panel Control

BOURNS®

Standard Resistance Table

Resistance (Ohms)	Resistance Code
1,000	102
2,000	202
5,000	502
10,000	103
20,000	203
50,000	503
100,000	104
200,000	204
500,000	504
1,000,000	105

Popular values listed in boldface. Consult factory for special resistances.

Date Code Description

YYWWMM

- M = COUNTRY OF MANUFACTURE (MEXICO)
- WW = WEEK NUMBER
- YY = LAST TWO DIGITS OF YEAR MANUFACTURED

How To Order

3310 Y - 0 0 1 - 103 L

Model Number Designator _____
 3310 = 9 mm Panel Control

Terminal Style Designator _____
 Single Cup:
 C = In-line Straight Terminals Side Exit 2.54 mm centers
 R = In-line Terminals Rear Exit 2.54 mm centers
 P = 5.08 mm x 2.54 mm Triangular Pattern Rear Exit
 Y = 5.08 mm x 5.08 mm Triangular Pattern Rear Exit

Dual Cup (Pot/Pot or Pot/Switch):
 H = Dual In-line Straight Terminals Rear Exit 2.54 mm centers

Shaft End Designator _____
 0 = Shaft End Slotted
 1 = Shaft End Flatted

Shaft Length Designator _____
 0 = 12.7 mm FMS Long Plastic Shaft (Available w/bushing only)
 1 = 19.05 mm FMS Long Plastic Shaft (Available w/bushing only)
 2 = 5.59 mm FMS Long Plastic Shaft (Bushingless version only)

Bushing Designator _____
 Pot (or Pot/Pot):
 1 = 6.35 mm x 6.35 mm Plastic
 5 = Bushingless (Board Level Control)

Pot/Switch Bushing Designator (use with "H" terminal style only.)
 3 = 6.35 mm x 6.35 mm Plastic
 6 = Bushingless (Board Level)

Resistance Code _____
 (1st 2 digits are significant, 3rd digit is number of 0s to follow)

RoHS Identifier _____
 L = Compliant

Specifications are subject to change without notice.

Users should verify actual device performance in their specific applications.

The products described herein and this document are subject to specific legal disclaimers as set forth on the last page of this document, and at www.bourns.com/docs/legal/disclaimer.pdf.

3310 – 9 mm Square Sealed Panel Control

BOURNS®

Product Dimensions

COMMON DIMENSIONS

3310-001

Plastic Bushing
Slotted Shaft

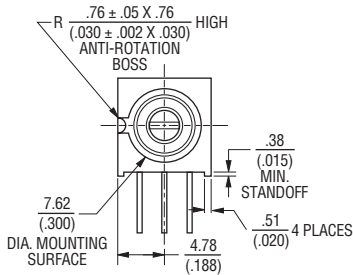
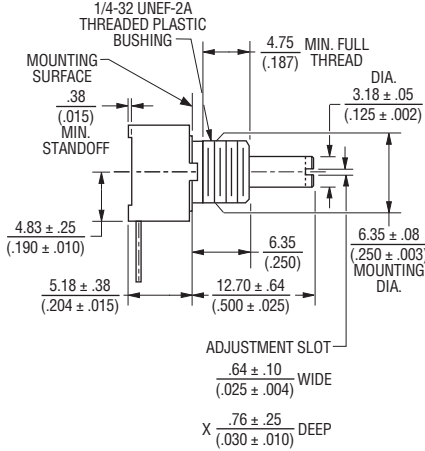
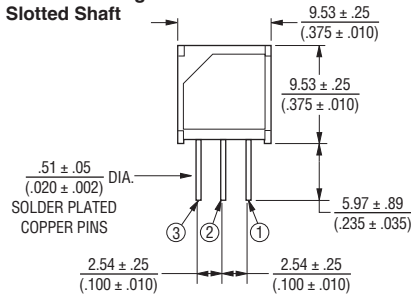

MOUNTING HOLE PATTERN

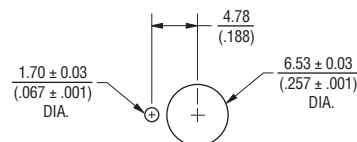

3310C-001

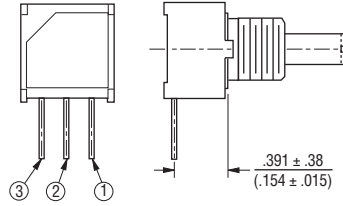

3310P-001

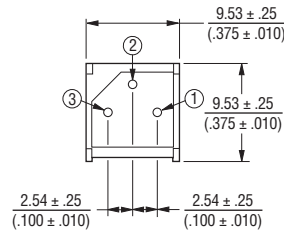

3310R-001

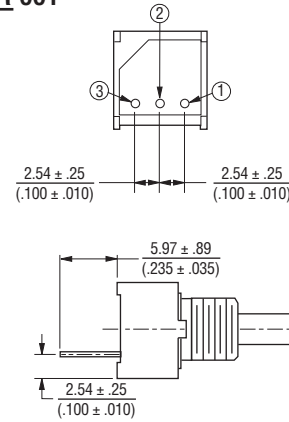

DIMENSIONS: $\frac{\text{MM}}{\text{(INCHES)}}$

3310Y-001

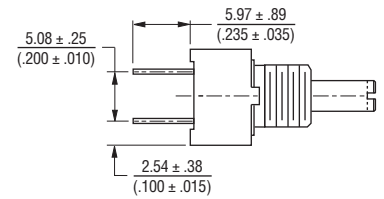
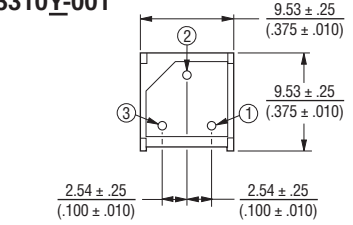

COMMON DIMENSIONS

3310C-101

Plastic Flatted Shaft

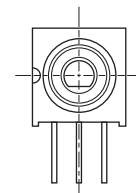
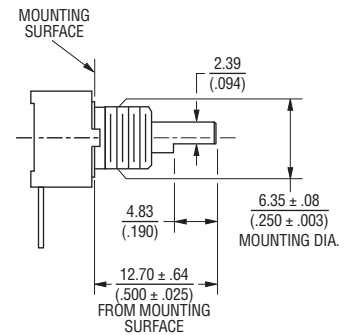

Specifications are subject to change without notice.

Users should verify actual device performance in their specific applications.

The products described herein and this document are subject to specific legal disclaimers as set forth on the last page of this document, and at www.bourns.com/docs/legal/disclaimer.pdf.

3310 – 9 mm Square Sealed Panel Control

BOURNS®

Product Dimensions

3310P-025* Bushingleess

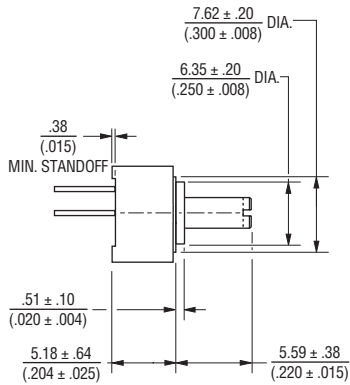

DIMENSIONS: $\frac{\text{MM}}{\text{(INCHES)}}$

Hardware

LOCKWASHER H-37-5

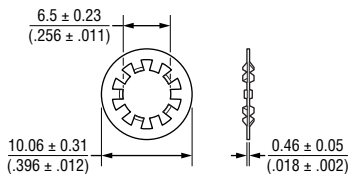

NUT H-38-1

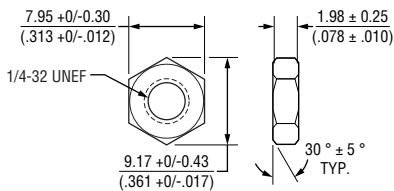

DIMENSIONS: $\frac{\text{MM}}{\text{(INCHES)}}$

COMMON DIMENSIONS 3310H-003 Pot/Switch Dual Cup Plastic Bushing

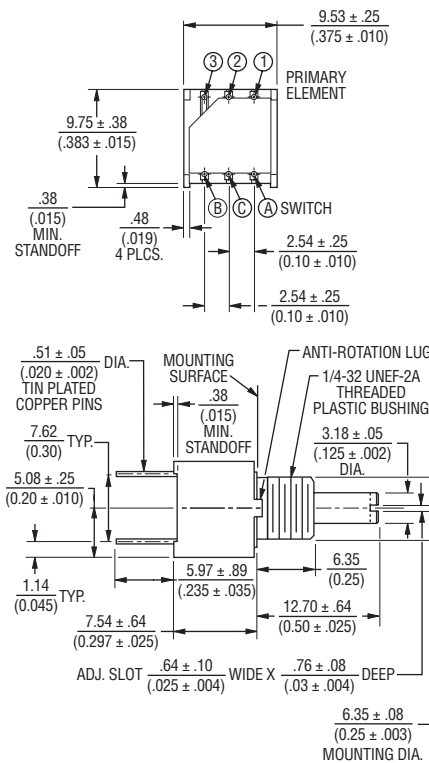

Pot/Pot Dual Cup

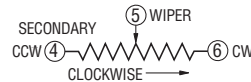
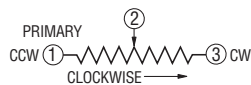

NOTE: * Only recommended shaft length for bushingless version

3310H-025* Pot/Pot Dual Cup Bushingleess

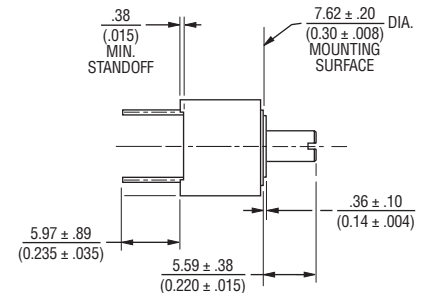
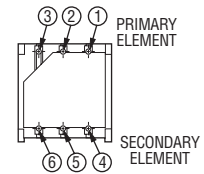

DIMENSIONS: $\frac{\text{MM}}{\text{(INCHES)}}$

Pot/Switch Dual Cup

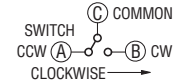
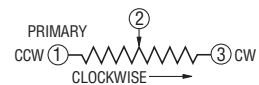

Pot Single Cup

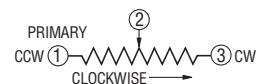

REV. 11/25

Specifications are subject to change without notice.

Users should verify actual device performance in their specific applications.

The products described herein and this document are subject to specific legal disclaimers as set forth on the last page of this document, and at www.bourns.com/docs/legal/disclaimer.pdf.

This legal disclaimer applies to purchasers and users of Bourns® products manufactured by or on behalf of Bourns, Inc. and its affiliates (collectively, "Bourns").

Unless otherwise expressly indicated in writing, Bourns® products and data sheets relating thereto are subject to change without notice. Users should check for and obtain the latest relevant information and verify that such information is current and complete before placing orders for Bourns® products.

The characteristics and parameters of a Bourns® product set forth in its data sheet are based on laboratory conditions, and statements regarding the suitability of products for certain types of applications are based on Bourns' knowledge of typical requirements in generic applications. The characteristics and parameters of a Bourns® product in a user application may vary from the data sheet characteristics and parameters due to (i) the combination of the Bourns® product with other components in the user's application, or (ii) the environment of the user application itself. The characteristics and parameters of a Bourns® product also can and do vary in different applications and actual performance may vary over time. Users should always verify the actual performance of the Bourns® product in their specific devices and applications, and make their own independent judgments regarding the amount of additional test margin to design into their device or application to compensate for differences between laboratory and real world conditions.

Unless Bourns has explicitly designated an individual Bourns® product as meeting the requirements of a particular industry standard (e.g., IATF 16949) or a particular qualification (e.g., UL listed or recognized), Bourns is not responsible for any failure of an individual Bourns® product to meet the requirements of such industry standard or particular qualification. Users of Bourns® products are responsible for ensuring compliance with safety-related requirements and standards applicable to their devices or applications.

Bourns® products are not recommended, authorized or intended for use in nuclear, lifesaving, life-critical or life-sustaining applications, nor in any other applications where failure or malfunction may result in personal injury, death, or severe property or environmental damage. Unless expressly and specifically approved in writing by two authorized Bourns representatives on a case-by-case basis, use of any Bourns® products in such unauthorized applications might not be safe and thus is at the user's sole risk. Life-critical applications include devices identified by the U.S. Food and Drug Administration as Class III devices and generally equivalent classifications outside of the United States.

Bourns expressly identifies those Bourns® standard products that are suitable for use in automotive applications on such products' data sheets in the section entitled "Applications." Unless expressly and specifically approved in writing by two authorized Bourns representatives on a case-by-case basis, use of any other Bourns® standard products in an automotive application might not be safe and thus is not recommended, authorized or intended and is at the user's sole risk. If Bourns expressly identifies a sub-category of automotive application in the data sheet for its standard products (such as infotainment or lighting), such identification means that Bourns has reviewed its standard product and has determined that if such Bourns® standard product is considered for potential use in automotive applications, it should only be used in such sub-category of automotive applications. Any reference to Bourns® standard product in the data sheet as compliant with the AEC-Q standard or "automotive grade" does not by itself mean that Bourns has approved such product for use in an automotive application.

Bourns® standard products are not tested to comply with United States Federal Aviation Administration standards generally or any other generally equivalent governmental organization standard applicable to products designed or manufactured for use in aircraft or space applications. Bourns expressly identifies Bourns® standard products that are suitable for use in aircraft or space applications on such products' data sheets in the section entitled "Applications." Unless expressly and specifically approved in writing by two authorized Bourns representatives on a case-by-case basis, use of any other Bourns® standard product in an aircraft or space application might not be safe and thus is not recommended, authorized or intended and is at the user's sole risk.

The use and level of testing applicable to Bourns® custom products shall be negotiated on a case-by-case basis by Bourns and the user for which such Bourns® custom products are specially designed. Absent a written agreement between Bourns and the user regarding the use and level of such testing, the above provisions applicable to Bourns® standard products shall also apply to such Bourns® custom products.

Users shall not sell, transfer, export or re-export any Bourns® products or technology for use in activities which involve the design, development, production, use or stockpiling of nuclear, chemical or biological weapons or missiles, nor shall they use Bourns® products or technology in any facility which engages in activities relating to such devices. The foregoing restrictions apply to all uses and applications that violate national or international prohibitions, including embargos or international regulations. Further, Bourns® products and Bourns technology and technical data may not under any circumstance be exported or re-exported to countries subject to international sanctions or embargoes. Bourns® products may not, without prior authorization from Bourns and/or the U.S. Government, be resold, transferred, or re-exported to any party not eligible to receive U.S. commodities, software, and technical data.

To the maximum extent permitted by applicable law, Bourns disclaims (i) any and all liability for special, punitive, consequential, incidental or indirect damages or lost revenues or lost profits, and (ii) any and all implied warranties, including implied warranties of fitness for particular purpose, non-infringement and merchantability.

For your convenience, copies of this Legal Disclaimer Notice with German, Spanish, Japanese, Traditional Chinese and Simplified Chinese bilingual versions are available at:

Web Page: <http://www.bourns.com/legal/disclaimers-terms-and-policies>

PDF: <http://www.bourns.com/docs/Legal/disclaimer.pdf>

Looking for pricing, stock, or lifecycle information?

Click below to explore more details on WIN SOURCE:

 [View 3310P-125-103L on WIN SOURCE](#)

 [Bourns Inc. Information](#)

Optimize Your Supply Chain with WIN SOURCE Solutions

-  Global Sourcing Solution
-  Obsolete Management
-  Cost Control Management
-  Shortage Management
-  Alternative Solution
-  Excess Inventory Management