



THE DATASHEET OF
772-E25-203R001



SPECIFICATIONS:

MATERIALS:

INSULATOR: GLASS-FILLED NYLON THERMOPLASTIC, UL94 V-0
 PROCESS TEMP: 260°C
 CONTACTS: GOLD PLATED BRASS
 SHELL: NICKEL PLATED STEEL
 SEALING MATERIAL: F04 FLEXIBLE ADHESIVE

ELECTRICAL:

RATED CURRENT: 5A
 WORKING VOLTAGE: 250VAC
 INSULATION RESISTANCE: 1000 MOhms MIN.
 CONTACT RESISTANCE: 15 mOhms MAX.

ENVIRONMENT:

OPERATING TEMPERATURE: -55°C TO +125°C

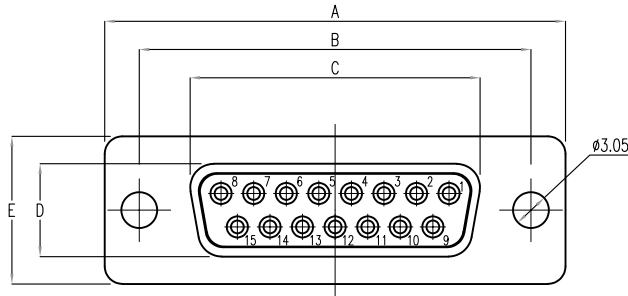

**WILL ACCEPT
26-20 AWG WIRE**

MEETS IP67 STANDARDS
(SEE PAGE 2 FOR SEALING DETAILS)

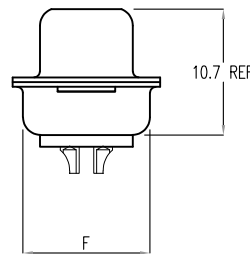
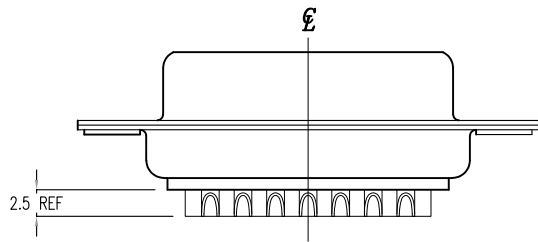

DIMENSIONS(mm)						
SIZE	A ^{+0.39} _{-0.39}	B ^{+0.25} _{-0.25}	C ^{+0.25} _{-0.25}	D ^{+0.25} _{-0.34}	E ^{+0.38} _{-0.38}	F ^{+0.25} _{-0.25}
9	30.81	24.99	16.33	7.90	12.55	10.80
15	39.19	33.32	24.66	7.90	12.55	10.80
25	53.04	47.04	38.38	7.90	12.55	10.80
37	69.32	63.50	54.84	7.90	12.55	10.80
50	67.00	61.10	52.20	10.90	15.40	13.30

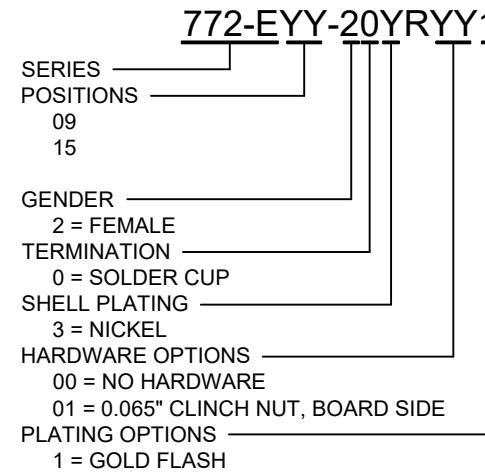

RoHS COMPLIANT

UNITS = mm

DO NOT SCALE FROM DRAWING



THESE DRAWINGS AND SPECIFICATIONS ARE THE PROPERTY OF NorComp AND SHALL NOT BE REPRODUCED, COPIED OR USED AS THE BASIS FOR THE MANUFACTURE OR SALE OF APPARATUS WITHOUT WRITTEN PERMISSION.

DRAWN:

C. SMITH

DATE:

03/26/2009

NorComp

SCALE:
NTS

SHEET 1 OF 2

REV 8

DWG NO.

772-EYY-20YRYY1

SEALING PROCESS

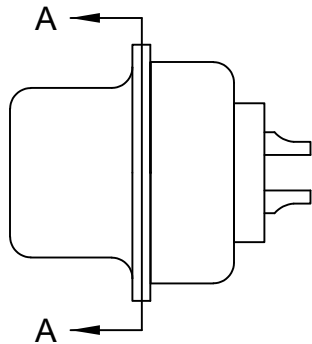

FRONT SEAL APPLIED BETWEEN FRONT INSULATOR AND FRONT METAL SHELL

MIDDLE SEAL APPLIED BETWEEN FRONT INSULATOR AND BACK INSULATOR

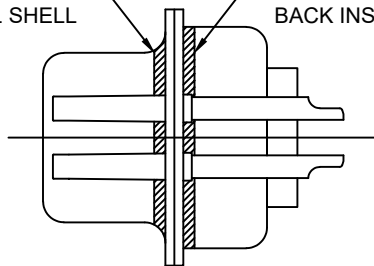

DETAIL A-A

HARDWARE OPTION

01X 0.065" (BOARD SIDE)

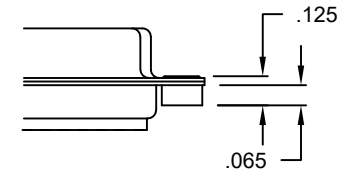

RoHS COMPLIANT



THESE DRAWINGS AND SPECIFICATIONS ARE THE PROPERTY OF NorComp AND SHALL NOT BE REPRODUCED, COPIED OR USED AS THE BASIS FOR THE MANUFACTURE OR SALE OF APPARATUS WITHOUT WRITTEN PERMISSION.

DRAWN:

C. SMITH

DATE:

03/26/2009

UNITS = inch

DO NOT SCALE FROM DRAWING

NorComp

SCALE:
NTS

SHEET 2 OF 2

REV 8

DWG NO.

772-EYY-20YRY1

Looking for pricing, stock, or lifecycle information?

Click below to explore more details on WIN SOURCE:

 [View 772-E25-203R001 on WIN SOURCE](#)

 [NorComp Inc. Information](#)

Optimize Your Supply Chain with WIN SOURCE Solutions

-  Global Sourcing Solution
-  Obsolete Management
-  Cost Control Management
-  Shortage Management
-  Alternative Solution
-  Excess Inventory Management