

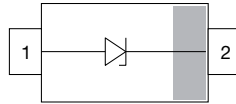

**THE DATASHEET OF
BZT52C5V1-HE3-18**



Small Signal Zener Diodes



MARKING (example only)

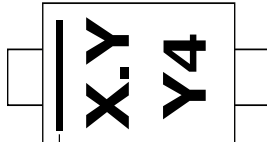

X.Y = type code
Y4 = date code

23210 Cathode mark

FEATURES

- Silicon planar Zener diodes
- The Zener voltages are graded according to the international E24 standard
- AEC-Q101 qualified available
- ESD capability according to AEC-Q101:
Human body model > 8 kV
Machine model > 800 V
- Base P/N-E3, RoHS-compliant, commercial grade
- Base P/N-HE3_A, RoHS-compliant, AEC-Q101 qualified
- Material categorization: for definitions of compliance please see www.vishay.com/doc?99912



RoHS
COMPLIANT

LINKS TO ADDITIONAL RESOURCES



PRIMARY CHARACTERISTICS		
PARAMETER	VALUE	UNIT
V _Z range nom.	2.2 to 75	V
Test current I _{ZT}	2; 5	mA
V _Z specification	Pulse current	
Circuit configuration	Single	

ORDERING INFORMATION					
DEVICE NAME	ORDERING CODE	ZENER VOLTAGE TOLERANCE	AEC-Q101 QUALIFIED	TAPED UNITS PER REEL	MINIMUM ORDER QUANTITY
BZT52 series	BZT52C2V2-E3-08 to BZT52C75-E3-08	5%	no	3000 (8 mm tape on 7" reel)	15 000/box
	BZT52B2V2-E3-08 to BZT52B75-E3-08	2%	no		
	BZT52C2V2-HE3_A-08 to BZT52C75-HE3_A-08	5%	yes		
	BZT52B2V2-HE3_A-08 to BZT52B75-HE3_A-08	2%	yes		
	BZT52C2V2-E3-18 to BZT52C75-E3-18	5%	no	10 000 (8 mm tape on 13" reel)	10 000/box
	BZT52B2V2-E3-18 to BZT52B75-E3-18	2%	no		
	BZT52C2V2-HE3_A-18 to BZT52C75-HE3_A-18	5%	yes		
	BZT52B2V2-HE3_A-18 to BZT52B75-HE3_A-18	2%	yes		

PACKAGE				
PACKAGE NAME	WEIGHT	MOLDING COMPOUND FLAMMABILITY RATING	MOISTURE SENSITIVITY LEVEL	SOLDERING CONDITIONS
SOD-123	10.6 mg	UL 94 V-0	MSL level 1 (according J-STD-020)	Peak temperature max. 260 °C

ABSOLUTE MAXIMUM RATINGS (T _{amb} = 25 °C, unless otherwise specified)					
PARAMETER	TEST CONDITION	SYMBOL	VALUE	UNIT	
Power dissipation	R _{thJL} = 250 K/W	P _{tot}	500	mW	
	On FR-4 board with recommended soldering footprint	P _{tot}	300	mW	
Zener current	See table "Electrical Characteristics"				
Thermal resistance junction to lead		R _{thJL}	250	K/W	
Thermal resistance junction to ambient	According to JEDEC® 51-3 on FR-4 board with recommended soldering footprint	R _{thJA}	420	K/W	
Junction temperature		T _j	150	°C	
Storage temperature range		T _{stg}	-65 to +150	°C	
Operating temperature range		T _{op}	-55 to +150	°C	



ELECTRICAL CHARACTERISTICS ($T_{amb} = 25\text{ }^{\circ}\text{C}$, unless otherwise specified)													
PART NUMBER	MARKING CODE	ZENER VOLTAGE RANGE ⁽¹⁾			TEST CURRENT		REVERSE VOLTAGE		DYNAMIC RESISTANCE		TEMP. COEFFICIENT	ADMISSIBLE ZENER CURRENT ⁽²⁾	
		V_Z at I_{ZT1}			I_{ZT1}	I_{ZT2}	V_R at I_R		Z_z at I_{ZT1}	Z_{ZK} at I_{ZT2}	α_{VZ}	I_z at $T_{amb} = 45\text{ }^{\circ}\text{C}$	I_z at $T_{amb} = 25\text{ }^{\circ}\text{C}$
		V			mA		V	nA	Ω		$10^{-4}/^{\circ}\text{C}$	mA	
		MIN.	TYP.	MAX.					MAX.	MAX.			
BZT52C2V2	Z9	2.09	2.2	2.31	5	1	> 1	100 000	120	600	-9 to -4	130	154
BZT52C2V4	Y1	2.28	2.4	2.52	5	1	> 1	50 000	100	600	-9 to -4	124	146
BZT52C2V7	Y2	2.57	2.7	2.84	5	1	> 1	20 000	83	500	-9 to -4	111	131
BZT52C3V0	Y3	2.85	3.0	3.15	5	1	> 1	10 000	95	500	-9 to -3	106	123
BZT52C3V3	Y4	3.14	3.3	3.47	5	1	> 1	5000	95	500	-8 to -3	103	118
BZT52C3V6	Y5	3.42	3.6	3.78	5	1	> 1	5000	95	500	-8 to -3	100	114
BZT52C3V9	Y6	3.71	3.9	4.10	5	1	> 1	2000	95	500	-7 to -3	94	107
BZT52C4V3	Y7	4.09	4.3	4.52	5	1	> 1	1000	95	500	-6 to -1	91	103
BZT52C4V7	Y8	4.47	4.7	4.94	5	1	> 1	500	78	500	-5 to +2	87	99
BZT52C5V1	Y9	4.85	5.1	5.36	5	1	> 0.8	100	60	480	-3 to +4	84	101
BZT52C5V6	YA	5.32	5.6	5.88	5	1	> 1	100	40	400	-2 to +6	75	91
BZT52C6V2	YB	5.89	6.2	6.51	5	1	> 2	100	10	150	-1 to +7	67	80
BZT52C6V8	YC	6.46	6.8	7.14	5	1	> 3	100	8	80	+2 to +7	60	72
BZT52C7V5	YD	7.13	7.5	7.88	5	1	> 5	100	7	50	+3 to +7	54	64
BZT52C8V2	YE	7.79	8.2	8.61	5	1	> 6	100	7	50	+4 to +7	48	57
BZT52C9V1	YF	8.65	9.1	9.56	5	1	> 7	100	10	50	+5 to +8	42	50
BZT52C10	YG	9.50	10	10.50	5	1	> 7.5	100	15	70	+5 to +8	38	45
BZT52C11	YH	10.45	11	11.55	5	1	> 8.5	100	20	70	+5 to +9	35	41
BZT52C12	YI	11.40	12	12.60	5	1	> 9	100	20	90	+6 to +9	32	37
BZT52C13	YK	12.40	13	13.65	5	1	> 10	100	25	110	+7 to +9	29	34
BZT52C15	YL	14.25	15	15.60	5	1	> 11	100	30	110	+7 to +9	25	29
BZT52C16	YM	15.30	16	16.80	5	1	> 12	100	40	170	+8 to +9.5	23	27
BZT52C18	YN	17.10	18	18.90	5	1	> 14	100	45	170	+8 to +9.5	21	24
BZT52C20	YO	19.00	20	21.00	5	1	> 15	100	50	220	+8 to +10	18	22
BZT52C22	YP	20.90	22	23.10	5	1	> 17	100	55	220	+8 to +10	17	20
BZT52C24	YR	22.80	24	25.20	5	1	> 18	100	70	220	+8 to +10	15	18
BZT52C27	YS	25.65	27	28.35	2	0.5	> 20	100	80	250	+8 to +10	14	16
BZT52C30	YT	28.50	30	31.50	2	0.5	> 22.5	100	80	250	+8 to +10	12	14
BZT52C33	YU	31.35	33	34.65	2	0.5	> 25	100	80	250	+8 to +10	11	13
BZT52C36	YW	34.20	36	37.80	2	0.5	> 27	100	87	250	+8 to +10	10	12
BZT52C39	YX	37.05	39	40.95	2	0.5	> 29	100	87	300	+8 to +12	9	11
BZT52C43	YY	40.85	43	45.15	2	0.5	> 32	100	97	375	+8 to +12	9	10
BZT52C47	YZ	44.65	47	49.35	2	0.5	> 35	100	97	375	+8 to +12	8	9
BZT52C51	Z1	48.45	51	53.55	2	0.5	> 38	100	100	400	+8 to +12	7	8
BZT52C56	Z2	53.20	56	58.80	2	0.5	> 42	100	135	425	+8 to +12	7	8
BZT52C62	Z3	58.90	62	65.10	2	0.5	> 46	100	150	450	+8 to +12	6	7
BZT52C68	Z4	64.60	68	71.40	2	0.5	> 51	100	200	475	+8 to +12	5	6
BZT52C75	Z5	71.25	75	78.75	2	0.5	> 56	100	250	500	+8 to +12	5	6

Notes

- $I_{ZT1} = 5\text{ mA}$, $I_{ZT2} = 1\text{ mA}$ or 0.5 mA
- (1) Measured with pulses $t_p = 5\text{ ms}$
- (2) Valid provided that electrodes are kept at ambient temperature



ELECTRICAL CHARACTERISTICS (T _{amb} = 25 °C, unless otherwise specified)													
PART NUMBER	MARKING CODE	ZENER VOLTAGE RANGE ⁽¹⁾			TEST CURRENT		REVERSE VOLTAGE		DYNAMIC RESISTANCE		TEMP. COEFFICIENT	ADMISSABLE ZENER CURRENT ⁽²⁾	
		V _Z at I _{ZT1}			I _{ZT1}	I _{ZT2}	V _R at I _R		Z _Z at I _{ZT1}	Z _{ZK} at I _{ZT2}	α _{VZ}	I _Z at T _{amb} = 45 °C	I _Z at T _{amb} = 25 °C
		V			mA		V	nA	Ω		10 ⁻⁴ /°C	mA	
		MIN.	TYP.	MAX.					MAX.	MAX.			
BZT52B2V2	U6	2.16	2.2	2.24	5	1	> 1	100000	120	600	-9 to -4	130	154
BZT52B2V4	V1	2.35	2.4	2.45	5	1	> 1	50000	100	600	-9 to -4	124	146
BZT52B2V7	V2	2.65	2.7	2.75	5	1	> 1	20000	83	500	-9 to -4	111	131
BZT52B3V0	V3	2.94	3.0	3.06	5	1	> 1	10000	95	500	-9 to -3	106	123
BZT52B3V3	V4	3.23	3.3	3.37	5	1	> 1	5000	95	500	-8 to -3	103	118
BZT52B3V6	V5	3.53	3.6	3.67	5	1	> 1	5000	95	500	-8 to -3	100	114
BZT52B3V9	V6	3.82	3.9	3.98	5	1	> 1	2000	90	500	-7 to -3	94	107
BZT52B4V3	V7	4.21	4.3	4.39	5	1	> 1	1000	90	500	-6 to -1	91	103
BZT52B4V7	V8	4.61	4.7	4.79	5	1	> 1	500	78	500	-5 to +2	87	99
BZT52B5V1	V9	5.00	5.1	5.20	5	1	> 0.8	100	60	480	-3 to +4	84	101
BZT52B5V6	VA	5.49	5.6	5.71	5	1	> 1	100	40	400	-2 to +6	75	91
BZT52B6V2	VB	6.08	6.2	6.32	5	1	> 2	100	10	150	-1 to +7	67	80
BZT52B6V8	VC	6.66	6.8	6.94	5	1	> 3	100	8	80	+2 to +7	60	72
BZT52B7V5	VD	7.35	7.5	7.65	5	1	> 5	100	7	50	+3 to +7	54	64
BZT52B8V2	VE	8.04	8.2	8.36	5	1	> 6	100	7	50	+4 to +7	48	57
BZT52B9V1	VF	8.92	9.1	9.28	5	1	> 7	100	10	50	+5 to +8	42	50
BZT52B10	VG	9.80	10	10.20	5	1	> 7.5	100	15	70	+5 to +8	38	45
BZT52B11	VH	10.78	11	11.22	5	1	> 8.5	100	20	70	+5 to +9	35	41
BZT52B12	VI	11.76	12	12.24	5	1	> 9	100	20	90	+6 to +9	32	37
BZT52B13	VK	12.74	13	13.26	5	1	> 10	100	25	110	+7 to +9	29	34
BZT52B15	VL	14.70	15	15.30	5	1	> 11	100	30	110	+7 to +9	25	29
BZT52B16	VM	15.68	16	16.32	5	1	> 12	100	40	170	+8 to +9.5	23	27
BZT52B18	VN	17.64	18	18.36	5	1	> 14	100	45	170	+8 to +9.5	21	24
BZT52B20	VO	19.60	20	20.40	5	1	> 15	100	50	220	+8 to +10	18	22
BZT52B22	VP	21.56	22	22.44	5	1	> 17	100	55	220	+8 to +10	17	20
BZT52B24	VR	23.52	24	24.48	5	1	> 18	100	70	220	+8 to +10	15	18
BZT52B27	VS	26.46	27	27.54	2	0.5	> 20	100	80	250	+8 to +10	14	16
BZT52B30	VT	29.40	30	30.60	2	0.5	> 22.5	100	80	250	+8 to +10	12	14
BZT52B33	VU	32.34	33	33.66	2	0.5	> 25	100	80	250	+8 to +10	11	13
BZT52B36	VW	35.28	36	36.72	2	0.5	> 27	100	87	250	+8 to +10	10	12
BZT52B39	VX	38.22	39	39.78	2	0.5	> 29	100	87	300	+8 to +12	9	11
BZT52B43	VY	42.14	43	43.86	2	0.5	> 32	100	97	375	+8 to +12	9	10
BZT52B47	VZ	46.06	47	47.94	2	0.5	> 35	100	97	375	+8 to +12	8	9
BZT52B51	U1	49.98	51	52.02	2	0.5	> 38	100	100	400	+8 to +12	7	8
BZT52B56	U2	54.88	56	57.12	2	0.5	> 42	100	135	425	+8 to +12	7	8
BZT52B62	U3	60.76	62	63.24	2	0.5	> 46	100	150	450	+8 to +12	6	7
BZT52B68	U4	66.64	68	69.36	2	0.5	> 51	100	200	475	+8 to +12	5	6
BZT52B75	U5	73.50	75	76.50	2	0.5	> 56	100	250	500	+8 to +12	5	6

Notes

- I_{ZT1} = 5 mA, I_{ZT2} = 1 mA or 0.5 mA
- (1) Measured with pulses t_p = 5 ms
- (2) Valid provided that electrodes are kept at ambient temperature



TYPICAL CHARACTERISTICS ($T_{amb} = 25\text{ }^{\circ}\text{C}$, unless otherwise specified)

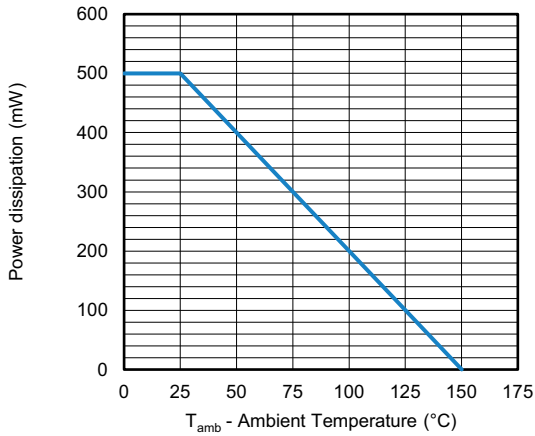

Fig. 1 - Admissible Power Dissipation vs. Ambient Temperature

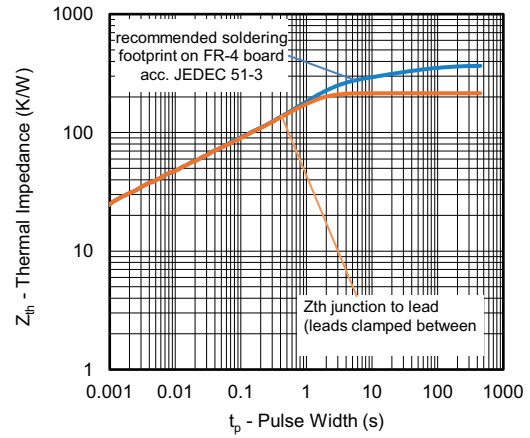
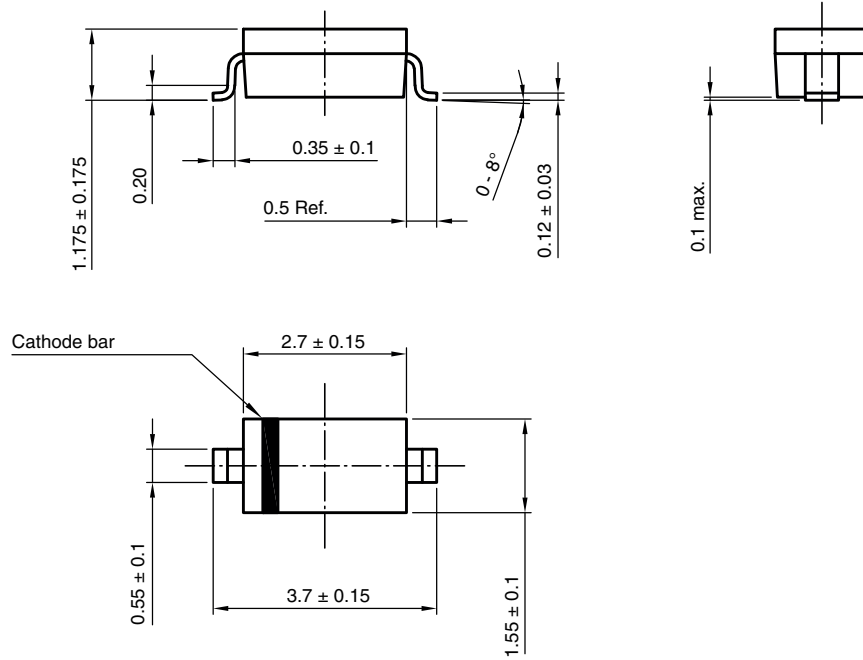

Fig. 2 - Thermal Impedance vs. Time



PACKAGE DIMENSIONS in millimeters (inches): **SOD-123**



Footprint recommendation:

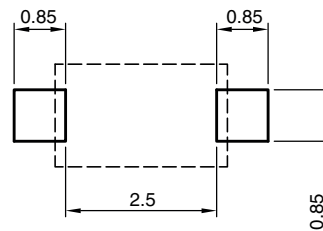

Created - Date: 18 Oct. 2021
Rev. 01 - Date: 18 Jan. 2022
Document no.: S8-V-3910.01-003 (4)



ORIENTATION IN CARRIER TAPE

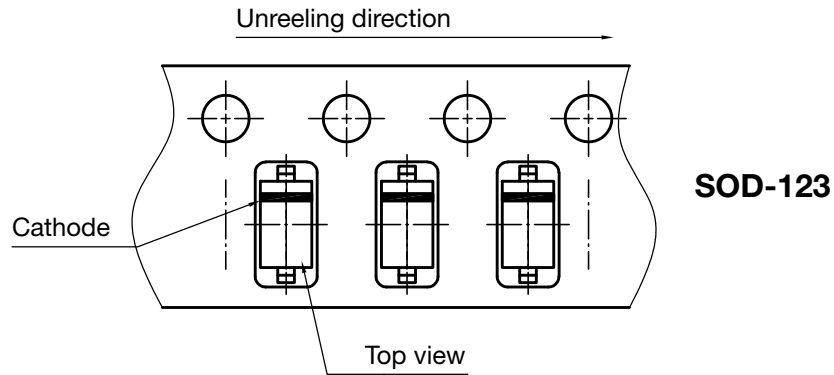

Created - Date: 09. Feb. 2016
 Rev. 01 - Date: 07. Nov. 2022
 Document no.: S8-V-3717.10-003 (4)

CARRIER TAPE

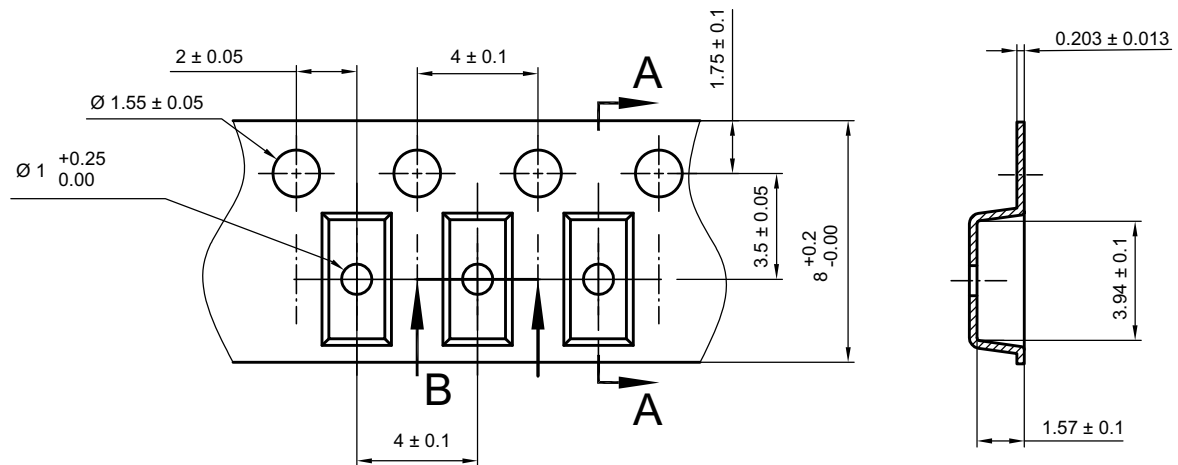

B-B Section

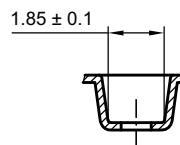

Created - Date: 07. Feb. 2013
 Rev. 01 - Date: 01. Mar. 2014
 Document no.: S8-V-3717.10-003 (4)



Disclaimer

ALL PRODUCT, PRODUCT SPECIFICATIONS AND DATA ARE SUBJECT TO CHANGE WITHOUT NOTICE TO IMPROVE RELIABILITY, FUNCTION OR DESIGN OR OTHERWISE.

Vishay Intertechnology, Inc., its affiliates, agents, and employees, and all persons acting on its or their behalf (collectively, "Vishay"), disclaim any and all liability for any errors, inaccuracies or incompleteness contained in any datasheet or in any other disclosure relating to any product.

Vishay makes no warranty, representation or guarantee regarding the suitability of the products for any particular purpose or the continuing production of any product. To the maximum extent permitted by applicable law, Vishay disclaims (i) any and all liability arising out of the application or use of any product, (ii) any and all liability, including without limitation special, consequential or incidental damages, and (iii) any and all implied warranties, including warranties of fitness for particular purpose, non-infringement and merchantability.

Statements regarding the suitability of products for certain types of applications are based on Vishay's knowledge of typical requirements that are often placed on Vishay products in generic applications. Such statements are not binding statements about the suitability of products for a particular application. It is the customer's responsibility to validate that a particular product with the properties described in the product specification is suitable for use in a particular application. Parameters provided in datasheets and / or specifications may vary in different applications and performance may vary over time. All operating parameters, including typical parameters, must be validated for each customer application by the customer's technical experts. Product specifications do not expand or otherwise modify Vishay's terms and conditions of purchase, including but not limited to the warranty expressed therein.

Hyperlinks included in this datasheet may direct users to third-party websites. These links are provided as a convenience and for informational purposes only. Inclusion of these hyperlinks does not constitute an endorsement or an approval by Vishay of any of the products, services or opinions of the corporation, organization or individual associated with the third-party website. Vishay disclaims any and all liability and bears no responsibility for the accuracy, legality or content of the third-party website or for that of subsequent links.

Vishay products are not designed for use in life-saving or life-sustaining applications or any application in which the failure of the Vishay product could result in personal injury or death unless specifically qualified in writing by Vishay. Customers using or selling Vishay products not expressly indicated for use in such applications do so at their own risk. Please contact authorized Vishay personnel to obtain written terms and conditions regarding products designed for such applications.

No license, express or implied, by estoppel or otherwise, to any intellectual property rights is granted by this document or by any conduct of Vishay. Product names and markings noted herein may be trademarks of their respective owners.

Looking for pricing, stock, or lifecycle information?

Click below to explore more details on WIN SOURCE:

 [View BZT52C5V1-HE3-18 on WIN SOURCE](#)

 [Vishay Information](#)

Optimize Your Supply Chain with WIN SOURCE Solutions

-  Global Sourcing Solution
-  Obsolete Management
-  Cost Control Management
-  Shortage Management
-  Alternative Solution
-  Excess Inventory Management