

6A05-G THRU 6A10-G (RoHS Device)

Voltage Range 50 to 1000 V
Current 6.0 Ampere

Features

- ★ Low forward voltage drop
- ★ High current capability
- ★ Low reverse leakage current
- ★ High surge current capability

Mechanical Data

- ★ Case: Molded plastic P600
- ★ Epoxy: UL 94V-0 rate flame retardant
- ★ Terminals: Solderable per MIL-STD-202 method 208 guaranteed
- ★ Polarity: Color band denotes cathode end
- ★ Mounting position: Any
- ★ Weight: 2.1 gram

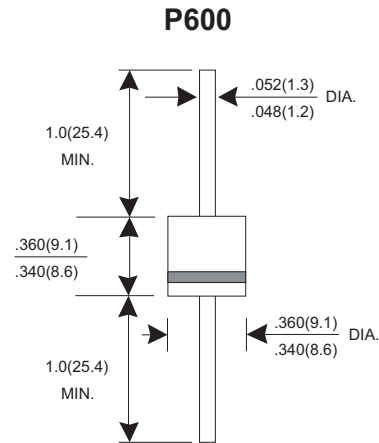

Dimensions in inches and (millimeters)

MAXIMUM RATINGS AND ELECTRICAL CHARACTERISTICS

Rating at 25°C ambient temperature unless otherwise specified.

Single phase, half wave, 60Hz, resistive or inductive load.

For capacitive load, derate current by 20%.

	SYMBOL	6A05-G	6A1-G	6A2-G	6A4-G	6A6-G	6A8-G	6A10-G	UNIT
Maximum Recurrent Peak Reverse Voltage	VRRM	50	100	200	400	600	800	1000	V
Maximum RMS Voltage	VRMS	35	70	140	280	420	560	700	V
Maximum DC Blocking Voltage	VDC	50	100	200	400	600	800	1000	V
Maximum Average Forward Rectified Current $T_L=50^\circ\text{C}$	I(AV)	6.0							A
Peak Forward Surge Current, 8.3ms single Half sine-wave superimposed on rated load (JEDEC method)	IFSM	250							A
Maximum Instantaneous Forward Voltage @ 6.0 A	VF	1.1							V
Maximum DC Reverse Current @ $T_J=25^\circ\text{C}$ At Rated DC Blocking Voltage @ $T_J=100^\circ\text{C}$	IR	5.0 500							uA uA
Typical junction Capacitance (Note 1)	CJ	100							pF
Typical Thermal Resistance (Note 2)	$R_{\theta JA}$	100							$^\circ\text{C/W}$
Operating Junction and Storage Temperature Range	T_J, T_{STG}	-55 to +125							$^\circ\text{C}$

NOTES : (1) Thermal Resistance junction to lead.

(2) Measured at 1.0 MHz and applied reverse voltage of 4.0 Volts DC.



RATINGS AND CHARACTERISTIC CURVES 6A05-G THRU 6A10-G

FIG.1 - FORWARD CURRENT DERATING CURVE

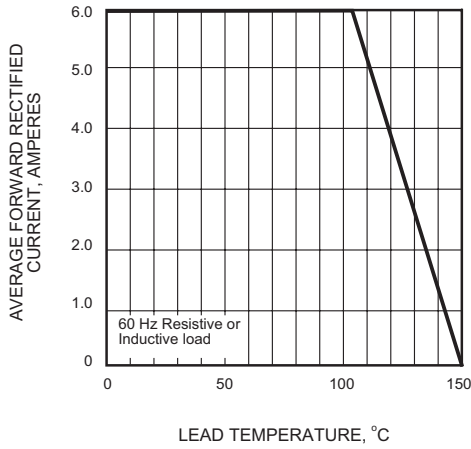

FIG.2 - MAXIMUM NON-REPETITIVE PEAK FORWARD SURGE CURRENT

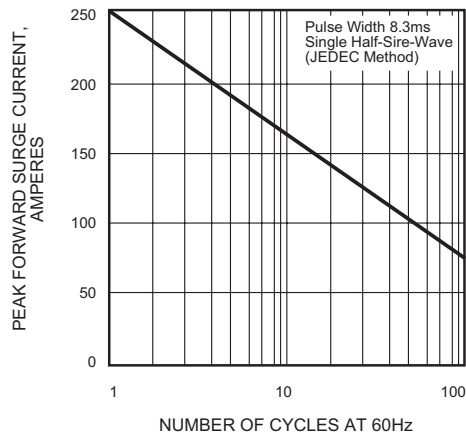

FIG.3 - TYPICAL INSTANTANEOUS FORWARD CHARACTERISTICS

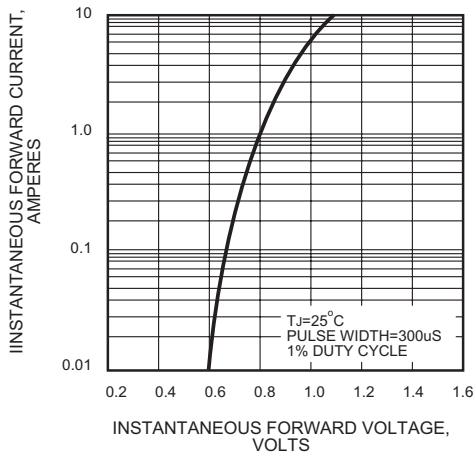

FIG.4 - TYPICAL REVERSE CHARACTERISTICS

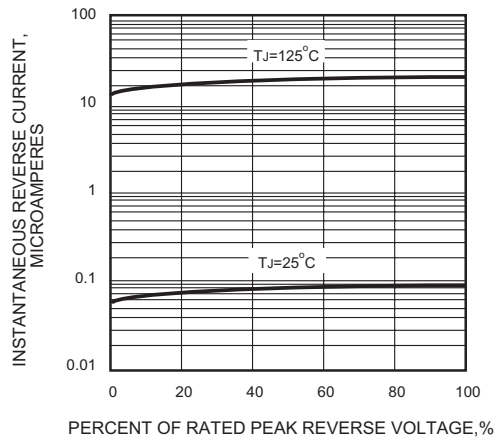
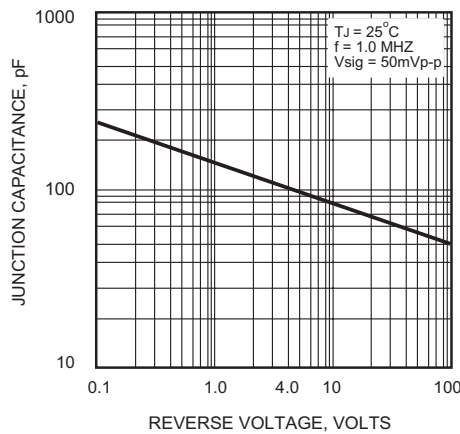



FIG.5 - TYPICAL JUNCTION CAPACITANCE



“-G” suffix designates RoHS compliant Version

Looking for pricing, stock, or lifecycle information?

Click below to explore more details on WIN SOURCE:

-  [View 6A04-G on WIN SOURCE](#)
-  [Comchip Technology Information](#)

Optimize Your Supply Chain with WIN SOURCE Solutions

-  Global Sourcing Solution
-  Obsolete Management
-  Cost Control Management
-  Shortage Management
-  Alternative Solution
-  Excess Inventory Management