



**THE DATASHEET OF
A10303RNZQ**



A Series

1-4 Pole Rotary Switches



Agency Approvals

Agency	Agency File Number
c UL US	E42363

Specifications

Contact Rating	Q (Silver) contact material: Switch - 2.5 amps @ 125 V AC; 1 amp @ 250 V AC; 350 mA @ 125 V DC (UL/CSA). Carry - 5 amps continuous. See page 5 for additional ratings.
Electrical Life	Up to 15,000 make-and-break cycles at full load up to 300,000 detent operations.
Contact Resistance	Below 20 m Ω typ. initial @ 2-4 V DC, 100 mA, for both silver and gold plated contacts.
Insulation Resistance	10 ⁹ Ω min.
Dielectric Strength	1,000 Vrms min. @ sea level. Operating and storage temp: -30° to 85°C
Operating & Storage Temperature	-30°C to 85°C

Description

Designers of applications for the automotive, major/small appliance and industrial equipment industries turn to the A series 1-4 pole rotary switches because of their reputation for being long-lasting and high quality. The A series features positive detent, shorting and non-shorting contacts and multi-pole and multi-position options.

Features & Benefits

- Multi-pole and multi-position
- Positive detent
- Shorting & non-shorting contacts
- Panel and PCB mounting
- RoHS Compliant

Applications

- Automotive
- Major and small appliances
- Industrial equipment
- Lighting

Materials

Housing & Bushing	Glass filled 6/6 nylon (UL 94V-0)
Actuator	
Movable Contact	Q (Silver) contact material: Copper alloy, silver plating. See page 5 for additional contact materials.
Stationary Contacts & Terminals	Q (Silver) contact material: Copper alloy, silver plating. See page 5 for additional contact materials.
Hardware	Nut - zinc, nickel plated. Lockwasher — steel, bright zinc plated. Stop Ring - brass, nickel plated
Terminal Seal	Epoxy

Notes: Any models supplied with Q, B or G contact material are RoHS compliant. Specifications and materials listed above are for switches with standard options. For information on specific and custom switches, consult Customer Service Center.

A Series

1-4 Pole Rotary Switches



Ordering Number

To order, simply select desired option from each category and place in the appropriate box. For additional options not shown in catalog, consult Customer Service Center.

Axxx - xx - x - x - xx - x - x

Switch Function

- A100:** SP, 30° Index, 12 pos. no stops
- A102:** SPDT, 30° Index
- A103:** SP, 30° Index, 3 pos.
- A104:** SP, 30° Index, 4 pos.
- A105:** SP, 30° Index, 5 pos.
- A106:** SP, 30° Index, 6 pos.
- A107:** SP, 30° Index, 7 pos.
- A108:** SP, 30° Index, 8 pos.
- A109:** SP, 30° Index, 9 pos.
- A110:** SP, 30° Index, 10 pos.
- A112:** SP, 30° Index, 12 pos.
- A114:** SP, 90° Index, 2 pos.
- A115:** SP, 45° Index, 3 pos.
- A124:** SP, 90° Index, 4 pos.
- A125:** SP, 45° Index, 8 pos.
- A203:** DP, 30° Index, 3 pos.
- A204:** DP, 30° Index, 4 pos.
- A205:** DP, 30° Index, 5 pos.
- A206:** DP, 30° Index, 6 pos.
- A214:** DP, 90° Index, 2 pos.
- A303:** 3P, 30° Index, 3 pos.
- A304:** 3P, 30° Index, 4 pos.
- A402:** 4PDT, 30° Index
- A403:** 4P, 30° Index, 3 pos

Actuator

- 15:** 1.500" high, flatted
- 03:** 0.375" high, flatted
- 05:** 0.500" high, flatted
- 14:** 1.500" high, flatted
- 42:** 1.654" high, metric
- S1:** Screwdriver Slot

Mounting Style

- R:** 3/8-32 threaded
- M:** M10 x .75 metric

Seal

- NONE:** No seal
- E:** Epoxy seal
- F:** Splashproof bushing seal
- K:** Epoxy & splashproof bushing seal

Contact Material

- Q:** Silver
- B:** Gold
- G:** Gold over Silver

Terminations

- Z:** Solder lug
- C:** PC Thru-hole
- MC:** Modular base

Shorting/Non-shorting Contacts

- N:** Non-Shorting contacts
 - S:** Shorting contacts
- (Not available with models A114, A124 & A214)

A Series

1-4 Pole Rotary Switches



Switch Function

30° Indexing			
No. Poles	Model No.	Switch Function	Terminals
SP	A100	12 Position No Stops	A, 1-12
	A102	SPDT	A, 1, 2 ¹
	A103	3 Position	1, 1-3 ¹
	A104	4 Position	1, 1-4 ¹
	A105	5 Position	1, 1-5 ¹
	A106	6 Position	1, 1-6 ¹
	A107	7 Position	1, 1-7 ¹
	A108	8 Position	1, 1-8 ¹
	A109	9 Position	1, 1-9 ¹
	A110	10 Position	1, 1-10 ¹
	A112	12 Position	1, 1-12 ¹
DP	A203	3 Position	A, C, 1-3, 7-9
	A204	4 Position	A, C, 1-4, 7-10
	A205	5 Position	A, C, 1-5, 7-11
	A206	6 Position	A, C, 1-12
3P	A303	3 Position	A, B, C, 1-3, 5-7, 9-11
	A304	4 Position	A, B, C, 1-12
4P	A402	4PDT	A, B, C, D, 1, 2, 4, 5, 6, 7, 8, 10, 11
	A403	3 Position	All Terminals

45° Indexing			
No. Poles	Model No.	Switch Function	Terminals
SP	A115	3 Position	A, 1, 2, 4 ¹
	A125	8 Position	A, 1, 2, 4, 5, 7, 8, 10, 11

90° Indexing			
No. Poles	Model No.	Switch Function	Terminals
SP	A114	2 Position	A, 1, 4 ¹
SP	A124	4 Position	A, 1, 4, 7, 10
DP	A214	2 Position	A, C, 1, 4, 7, 10

SP Models Schematic

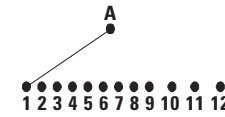

DP Models Schematic

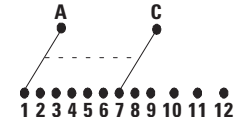

3P Models Schematic

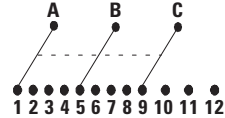

4P Models Schematic

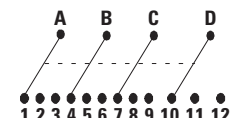

Terminal Numbers

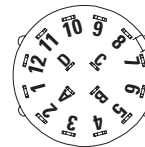

Terminal numbers molded on bottom of housing.

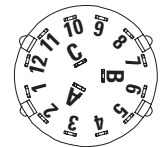

4P Models
SP Models (omit terminals B, C & D)
DP Models (omit terminals B & D)

3P Models

Dimension in Inch (mm)

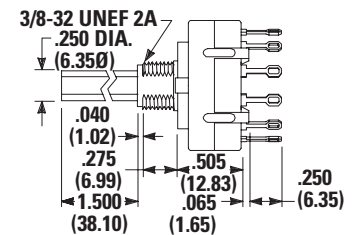
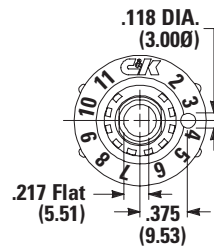

TERM. NOS.
Molded on Housing

Notes:

1. These models with "C" or "MC" terminations have additional terminal no. 9 as switch support only. This terminal is not connected electrically inside switch.

All models with all options when ordered with 'G' or 'Q' contact material, see page 5.

A Series

1-4 Pole Rotary Switches



Actuator inches (mm)

15 1.500" High

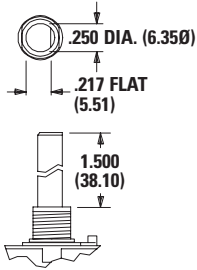

03 0.375" High

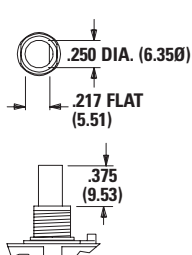

05 0.500" High

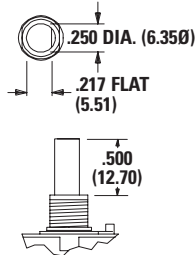

14 1.500" High

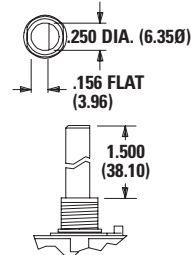

42 1.654" Metric

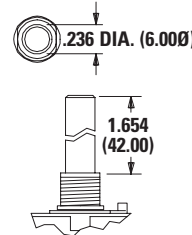

S1 Screwdriver Slot

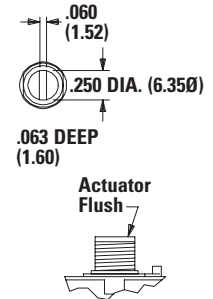

Notes: Actuators shown in position 1, fully CCW.

Mounting Style inches (mm)

R 3/8-32 Thread

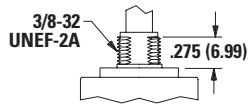

Panel Mounting

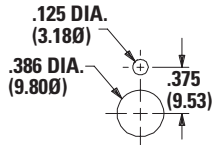

3/8 IN. BUSHING

M M10 x 0.75 Metric

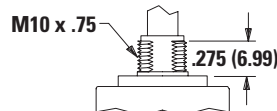

Panel Mounting

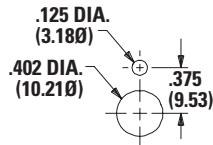

METRIC BUSHING

Typical Installation

Maximum force to push on knob should not exceed 10 lbs.

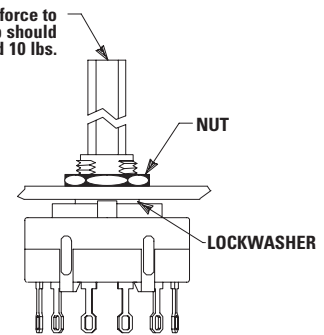

Install switch with stop ring (if used) and lockwasher in back of panel. Tighten hex nut from front of panel. On PC mounted switches, use hex nut and lockwasher to hold stop ring in place.

Actuation torque: 8-16 oz./in.
Maximum torque: 30 oz./in.

Shorting/Non-Shorting Contacts

N Non-Shorting Contacts (break-before-make)

S Shorting Contacts (make-before-break)

Notes: 'S' shorting contacts are not available with A114, A124 and A214 models.

A Series

1-4 Pole Rotary Switches



Terminations

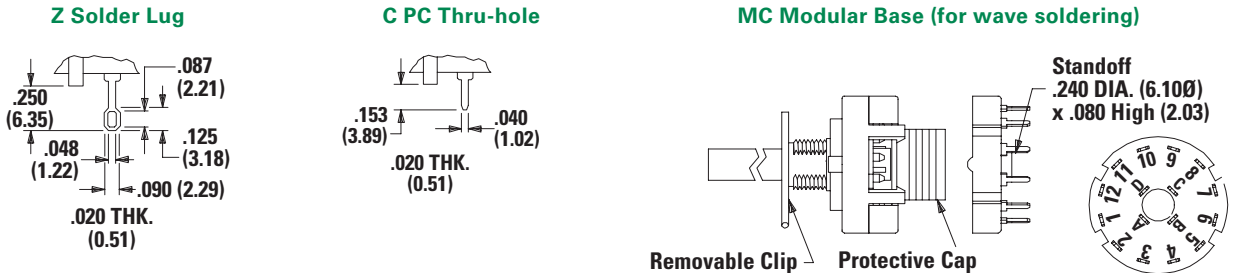

Notes:

Switches with 'C' or 'MC' terminations have additional terminal no. 9 as switch support only. This terminal is not connected electrically inside switch. Solder and clean switch base on PC board with other components, then snap on housing/actuator assembly. See page 6 for installation instructions.

PC Mounting

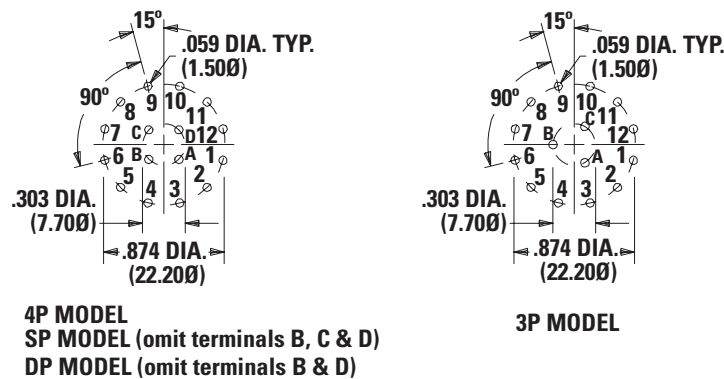

Contact Material

Option Code	Contact Material	Typical Usage	Rating	Cycles
Q	Silver ²	Power	Switch – 2.5 amps @ 125 VAC; 1 amp @ 250 VAC (UL/CSA) Carry – 5 amps continuous	6,000
			Switch – 350 mA @ 125 VDC (UL/CSA) Carry – 5 amps continuous	15,000
B	Gold ¹	Low Level / Dry Circuit	0.4 VA max. @ 20 V AC or DC max	15,000
G	Gold over Silver ³	Low Level / Dry Level Circuit or Power	0.4 VA max. @ 20 V AC or DC max	15,000
			Switch – 350 mA @ 125 VDC (UL/CSA) Carry – 5 amps continuous	
			Switch – 2.5 amps @ 125 VAC; 1 amp @ 250 VAC (UL/CSA) Carry – 5 amps continuous	6,000

Notes: See Technical Data section of this catalog for RoHS compliant and compatible definition and specifications.

1. Movable Contacts: Copper alloy, with gold plate over nickel plate.

Stationary Contacts & Terminals: Copper alloy, with gold plate over nickel plate.

2. Movable Contacts: Copper alloy, silver plated.

Stationary Contacts & Terminals: Copper alloy, silver plated (standard with all termination options).

3. Movable Contacts: Copper alloy, with gold plate over nickel plate over silver plate.

Stationary Contacts & Terminals: Copper alloy, with gold plate over nickel plate over silver plate.

Any models supplied with Q, B or G contact material are RoHS compliant.

All models **comply** with all options when ordered with 'G' or 'Q' contact material.

'G' contact material is equivalent to both 'B' and 'Q' contact materials.

A Series

1-4 Pole Rotary Switches



Function

None No Seal

E Epoxy Seal

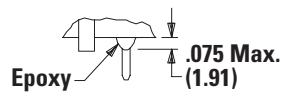

F Splashproof Bushing Seal

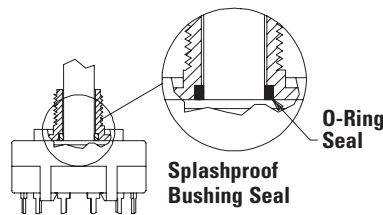

K Epoxy & Splashproof Bushing Seal

Setting Stops on A112 and A125 Models

The number of switch positions is adjustable on A112 and A125 models only by means of a stop ring provided with each switch. The number of positions is pre-set on all other models and the stop ring is factory installed.

To set stops: Turn shaft fully counter-clockwise and insert stop ring tab in desired hole. Install lockwasher and nut to retain stop ring for both PC and panel mounting. Switch without stop ring has 12 positions.

Soldering, Cleaning and Assembly Instructions for 'MC' Termination Option

Soldering

1. Insert switch base only into PC board.
2. Do not bend terminals.
3. Wave soldering recommended at 500F solder temperature.
4. Hand solder at 500F, 10 sec. max./ terminal.

Switch Assembly

1. Hold housing/shaft assembly by housing. Remove protective cap by squeezing tabs and discard. (FIG. 1)
2. Do not push on switch shaft. Detent mechanism will come apart.
3. While holding switch housing, align locating tab on base with notch on housing and engage 4 housing latches in slots on base. (FIG. 2)
4. Push firmly on housing until latches snap in place.
5. Remove clip from shaft and discard. Assembly is complete. (FIG. 3)

Cleaning

1. Flux clean using vapor degreaser and forced rinse or triple bath method.
2. Do not allow switch base to 'trap' fluids.
3. Freon TMC, TF or Methylene Chloride give excellent results.

Available Hardware

Stop ring
Part No.
767B00201
Material: Brass
Finish: Nickel plated

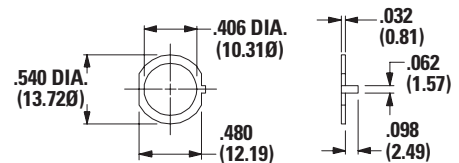

REMOVABLE CLIP

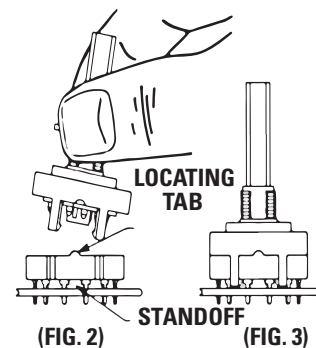
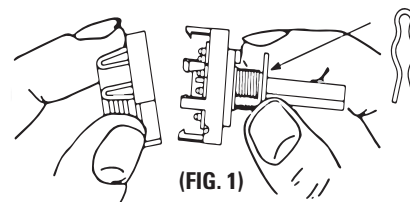

Looking for pricing, stock, or lifecycle information?

Click below to explore more details on WIN SOURCE:

 [View A10303RNZQ](#) on WIN SOURCE

 [C&K Components](#) Information

Optimize Your Supply Chain with WIN SOURCE Solutions

-  Global Sourcing Solution
-  Obsolete Management
-  Cost Control Management
-  Shortage Management
-  Alternative Solution
-  Excess Inventory Management