



**THE DATASHEET OF
403C11A26M00000**



Model 403

Surface Mount Crystal

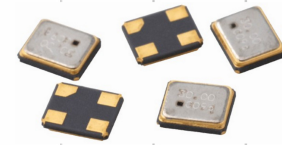

Part Dimensions:
3.2 x 2.5 x 0.75mm • 18.0001mg

Features

- Hermetic Ceramic Surface Mount Package
- Fundamental Crystal Design
- Frequency Range 8 – 80MHz
- Frequency Tolerance, ±30ppm Standard
- Frequency Stability, ±30ppm Standard
- Operating Temperature Range to -40°C to +105°C
- Tape and Reel Packaging, EIA-481

Standard Frequencies – see Page 5 for common frequencies.
* Check with factory for availability of frequencies not listed.

Applications

- IoT and IIoT Applications
- Wireless Communications
- FPGA/Microcontrollers
- USB Interfaces
- Computer Peripherals
- Portable Equipment
- Test and Measurement
- M2M Communications
- Broadband Access

Description

CTS Model 403 incorporates a high Q quartz resonator and is ideal for supporting a wide range of commercial and industrial applications.

Ordering Information

Model	Temperature Range	Tolerance @ +25°C	Temperature Stability	Load Capacitance	Frequency [MHz]
403	C	3	3	A	XXMXXXXX

Code	Temp. Range
C	-20°C to +70°C ¹
D	-30°C to +85°C ¹
I	-40°C to +85°C ²
G	-40°C to +105°C ³

Code	Stability
1	±10ppm
X	±15ppm
2	±20ppm
Y	±25ppm
3	±30ppm
5	±50ppm

Code	Frequency
Frequency ⁴	

Code	Tolerance	Code	Tolerance
1	±10ppm	Y	±25ppm
X	±15ppm	3	±30ppm
2	±20ppm		

Code	Capacitance	Code	Capacitance	Code	Capacitance
V	7pF	L	12pF	E	20pF
K	8pF	B	13pF	F	24pF
J	9pF	C	16pF	G	30pF
A	10pF	D	18pF	S	Series

Notes:

- 1] Available with all stability codes.
- 2] Available with stability codes X, 2, Y, 3 and 5.
- 3] Available with stability codes 3 and 5.
- 4] Frequency is recorded with 2 leading digits before the "M" and 5 significant digits after the "M" [including zeroes].
(Ex. XXMXXXXX [16M38400], XXMXXXXX [22M11840], XXMXXXXX [14M31818])

Not all performance combinations and frequencies may be available.
Contact your local CTS Representative or CTS Customer Service for availability.

This product is specified for use only in standard commercial applications. Supplier disclaims all express and implied warranties and liability in connection with any use of this product in any non-commercial applications or in any application that may expose the product to conditions that are outside of the tolerances provided in its specification.



Electrical Specifications

Operating Conditions

PARAMETER	SYMBOL	CONDITIONS	MIN	TYP	MAX	UNIT
Operating Temperature	T _A	-	-20		+70	°C
			-30	+25	+85	
			-40		+85	
			-40		+105	
Storage Temperature	T _{STG}	-	-55	-	+125	°C

Frequency Stability

PARAMETER	SYMBOL	CONDITIONS	MIN	TYP	MAX	UNIT
Frequency Range	f ₀	Fundamental Mode		8 - 80		MHz
Frequency Tolerance	Δf/f ₀	@ +25°C		10, 15, 20, 25 or 30		±ppm
Frequency Stability	Δf/f ₂₅	Referenced to +25°C reading		10, 15, 20, 25, 30 or 50		±ppm
Aging	Δf/f ₀	Typical per year @ +25°C	-3	-	3	ppm

Crystal Parameters

PARAMETER	SYMBOL	CONDITIONS	MIN	TYP	MAX	UNIT
Operating Mode	-	-		Fundamental		-
Crystal Cut	-	-		AT-Cut Strip		-
Load Capacitance	C _L	-		See Ordering Information		pF
Shunt Capacitance	C ₀	-	-	-	3.0	pF
Series Resistance						
Fundamental	R ₁	8MHz - <10MHz	-	-	400	Ω
		10MHz - <11MHz	-	-	200	
		11MHz - <12MHz	-	-	120	
		12MHz - <13MHz	-	-	100	
		13MHz - <16MHz	-	-	80	
		16MHz - <21MHz	-	-	60	
		21MHz - <30MHz	-	-	50	
30MHz - 80MHz	-	-	40			
Drive Level	DL	-	-	10	300	μW
Insulation Resistance	R _i	+100Vdc ±15Vdc	500	-	-	MΩ

Δf/f₀ - Frequency deviation referenced to nominal frequency.

Δf/f₂₅ - Frequency deviation over operating temperature range, referenced to +25°C frequency.

Mechanical Specifications

Package Drawing

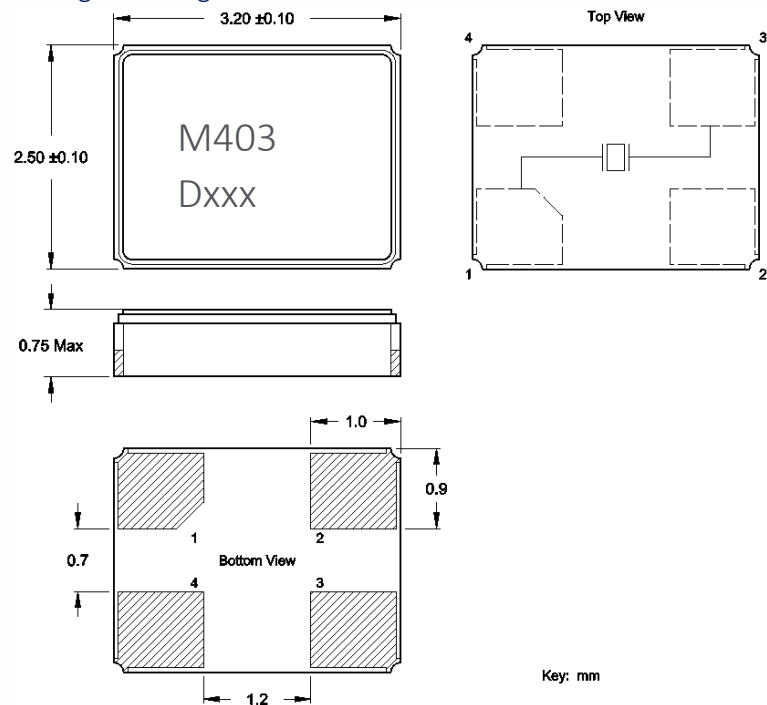

Marking Information

1. M403 – CTS Model series.
2. D – Date code. See Table I for codes.
3. xxx – Frequency code, 3-digits frequencies below 100MHz.
[See document 016-1454-0, Frequency Code Tables].

Recommended Pad Layout

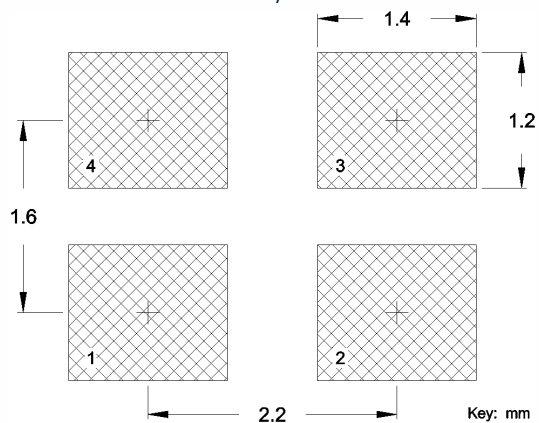

Notes

1. JEDEC termination code (e4). Barrier-plating is nickel [Ni] with gold [Au] flash plate.
2. Terminations #2, #4 and the metal lid are connected internally. End user may connect these pins to circuit ground for EMI suppression.
3. Due to package variability, the pad chamfer on the bottom could be located on Pin 1 in a given lot. Layout orientation should be based on the top view [marking side], as indicated in package drawing. The chamfer location does not affect the electrical performance of the device.
4. Reflow conditions per JEDEC J-STD-020; +260°C maximum, 20 seconds.
5. MSL = 1.

Table I – Date Code, Beginning year 2021

MONTH					YEAR											
					JAN	FEB	MAR	APR	MAY	JUN	JUL	AUG	SEP	OCT	NOV	DEC
2021	2025	2029	2033	2037	A	B	C	D	E	F	G	H	J	K	L	M
2022	2026	2030	2034	2038	N	P	Q	R	S	T	U	V	W	X	Y	Z
2023	2027	2031	2035	2039	a	b	c	d	e	f	g	h	j	k	l	m
2024	2028	2032	2036	2040	n	p	q	r	s	t	u	v	w	x	y	z

Packaging – Tape and Reel

Tape Drawing

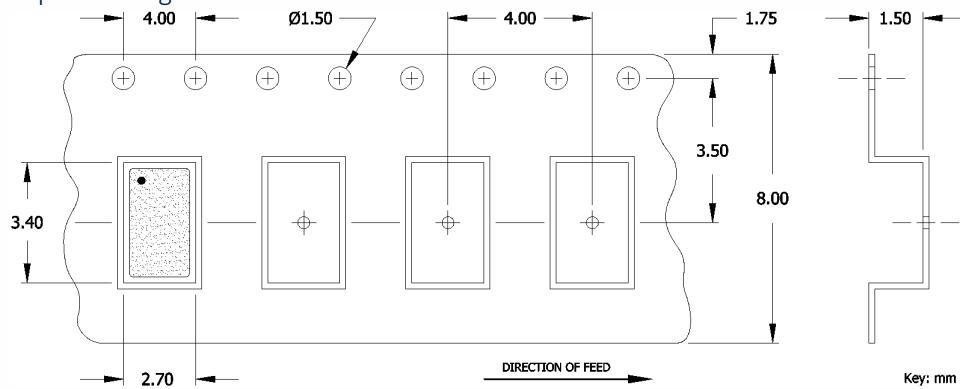

Reel Drawing

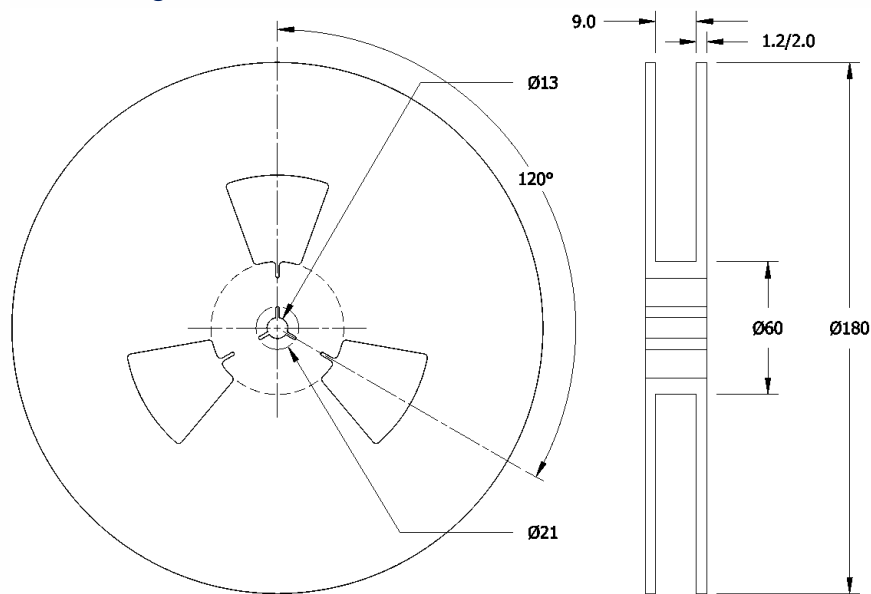

Notes

1. Device quantity is 1k pieces minimum and 3k pieces maximum per 180mm reel.
2. Complete CTS part number, frequency value, date code and manufacturing site code information must appear on reel and carton labels.



Addendum



Common Frequencies and Frequency Codes – MHz

Common Wireless Frequencies **Additional Frequencies**

FREQUENCY	FREQUENCY CODE	FREQUENCY	FREQUENCY CODE	FREQUENCY	FREQUENCY CODE	FREQUENCY	FREQUENCY CODE
12.000000	120	8.000000	080	19.440000	194	31.250000	312
13.560000	13C	10.000000	100	19.660800	19B	32.768000	327
16.000000	160	11.059200	111	19.680000	196	33.000000	330
19.200000	192	12.288000	122	20.480000	204	33.330000	333
20.000000	200	12.500000	125	20.736000	207	33.333000	33E
24.000000	240	12.688000	126	22.118400	221	33.333300	33A
25.000000	250	12.800000	128	22.579200	225	33.868800	338
26.000000	260	13.000000	130	24.305000	243	35.328000	353
27.120000	271	13.500000	135	24.545400	24F	36.000000	360
30.000000	300	13.553750	13B	24.545454	24G	37.500000	375
32.000000	320	13.824000	138	24.553500	24B	38.000000	380
37.400000	374	13.934400	139	24.576000	24C	38.880000	388
38.400000	384	14.000000	140	25.000625	25A	39.062500	39A
40.000000	400	14.318180	143	26.041660	26F	41.600000	41C
48.000000	480	14.400000	144	26.800000	268	44.000000	440
52.000000	520	14.745600	147	27.000000	270	45.000000	450
		15.360000	153	27.600000	27C	49.152000	491
		16.367600	16E	28.224000	282	50.000000	500
		16.368000	16C	28.322000	28C	54.000000	540
		16.384000	163	28.375000	283	75.000000	750
		16.666700	16N	28.636360	286	114.285000	1142
		16.800000	168	29.491200	29B	156.250000	1562
		16.934400	169	29.491200	29B		
		18.000000	180	30.400000	304		
		18.432000	184	30.720000	307		

Looking for pricing, stock, or lifecycle information?

Click below to explore more details on WIN SOURCE:

-  [View 403C11A26M00000 on WIN SOURCE](#)
-  [CTS-Frequency Controls Information](#)

Optimize Your Supply Chain with WIN SOURCE Solutions

-  Global Sourcing Solution
-  Obsolete Management
-  Cost Control Management
-  Shortage Management
-  Alternative Solution
-  Excess Inventory Management