



**THE DATASHEET OF
FXP72.07.0053A**





TAOGLAS®



Datasheet

Freedom

Part No:
FXP72.07.0053A

Description

2.4GHz Freedom Flexible PCB Antenna
with 53mm 1.13 Cable and IPEX MHFI (U.FL) Connector

Features:

- Low profile antenna
- Ground Coupling Effect
- Flexible PCB Antenna with 3M adhesive
- Dimensions: 31 x 30.4 x 0.2mm
- Cable: 53mm 1.13
- Connector: IPEX MHFI (U.FL)
- RoHS & Reach Compliant

1.	Introduction	3
2.	Specification	4
3.	Antenna Characteristics	5
4.	Radiation Patterns	9
5.	Mechanical Drawing	13
6.	Mounting Guidelines	14
7.	Packaging	16
<hr/>		
	Changelog	17

Taoglas makes no warranties based on the accuracy or completeness of the contents of this document and reserves the right to make changes to specifications and product descriptions at any time without notice. Taoglas reserves all rights to this document and the information contained herein. Reproduction, use or disclosure to third parties without express permission is strictly prohibited.

Ireland & USA
ISO 9001:2015
Certified



Taiwan
ISO 9001:2015
Certified



1. Introduction



The Taoglas FXP72 Freedom Flexible PCB Antenna is engineered for optimum performance on Wi-Fi®, ZigBee®, Bluetooth® and ISM band at 2.4GHz. This antenna has been designed as an easy-to-integrate solution that covers all current market 2.4GHz applications. The antenna has been designed for integration on different plastics material and thickness but it is optimized for 2mm thick ABS plastic as a baseline for testing.

Many module manufacturers specify peak gain limits for any antennas that are to be connected to that module. Those peak gain limits are based on free-space conditions. In practice, the peak gain of an antenna tested in free-space can degrade by at least 1 or 2dBi when put inside a device. So ideally you should go for a slightly higher peak gain antenna than mentioned on the module specification to compensate for this effect, giving you better performance.

Upon testing of any of our antennas with your device and a selection of appropriate layout, integration technique, or cable, Taoglas can make sure any of our antennas' peak gain will be below the peak gain limits. Taoglas can then issue a specification and/or report for the selected antenna in your device that will clearly show it complying with the peak gain limits, so you can be assured you are meeting regulatory requirements for that module.

For example, a module manufacturer may state that the antenna must have less than 2dBi peak gain, but you don't need to select an embedded antenna that has a peak gain of less than 2dBi in free-space. This will give you a less optimized solution. It is better to go for a slightly higher free-space peak gain of 3dBi or more if available. Once that antenna gets integrated into your device, performance will degrade below this 2dBi peak gain due to the effects of GND plane, surrounding components, and device housing. If you want to be absolutely certain, contact Taoglas and we will test your device for you. Choosing a Taoglas antenna with a higher peak gain than what is specified by the module manufacturer and enlisting our help will ensure you are getting the best performance possible without exceeding the peak gain limits.

The cable and connector are fully customizable, for more information please contact your regional Taoglas customer support team.

2. Specification

Wi-Fi Electrical								
Band	Frequency (MHz)	Efficiency (%)	Average Gain (dB)	Peak Gain (dBi)	Impedance	Polarization	Radiation Pattern	Max. input power
Wi-Fi - 2GHz	2400-2500	67.9	-1.68	3.06	50 Ω	Linear	Omni	10W

Mechanical	
Dimensions	31 x 30.4 x 0.2 mm
Weight	1.2 g
Connector	MHFI (U.FL Compatible)
Cable	53mm of Mini-Coax 1.13 mm
Adhesive	3M 467

Environmental	
Operation Temperature	-40°C to 85°C
Storage Temperature	-40°C to 85°C
Relative Humidity	Non-condensing 65°C 95% RH

3. Antenna Characteristics

3.1 Test Setup

AUT



Vector Network Analyzer

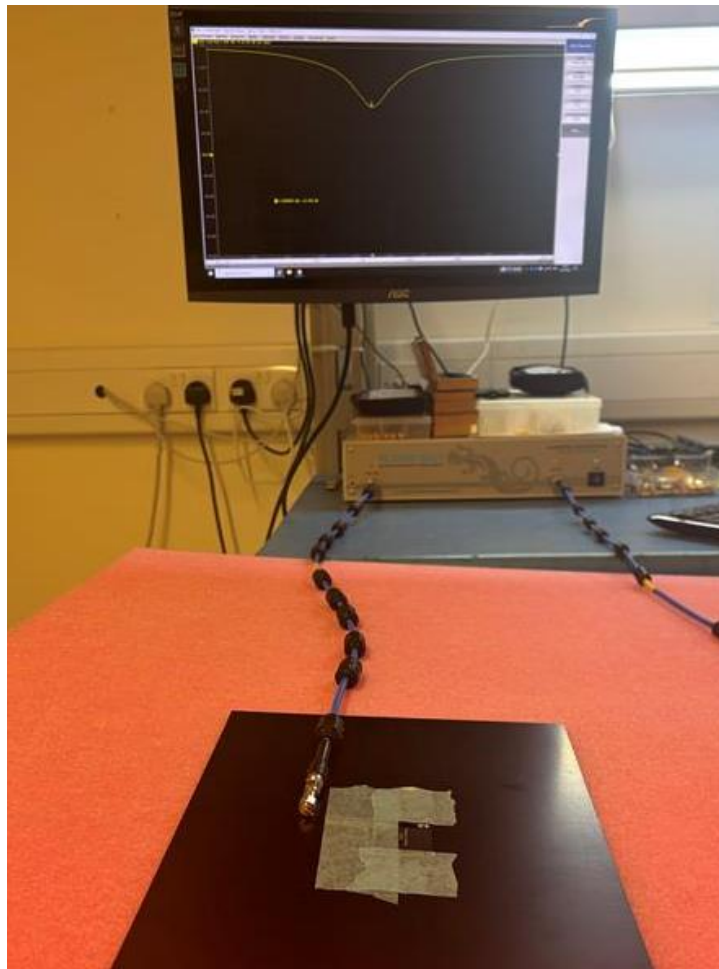

VNA Test Set-up on 1mm ABS

3.2 Return Loss

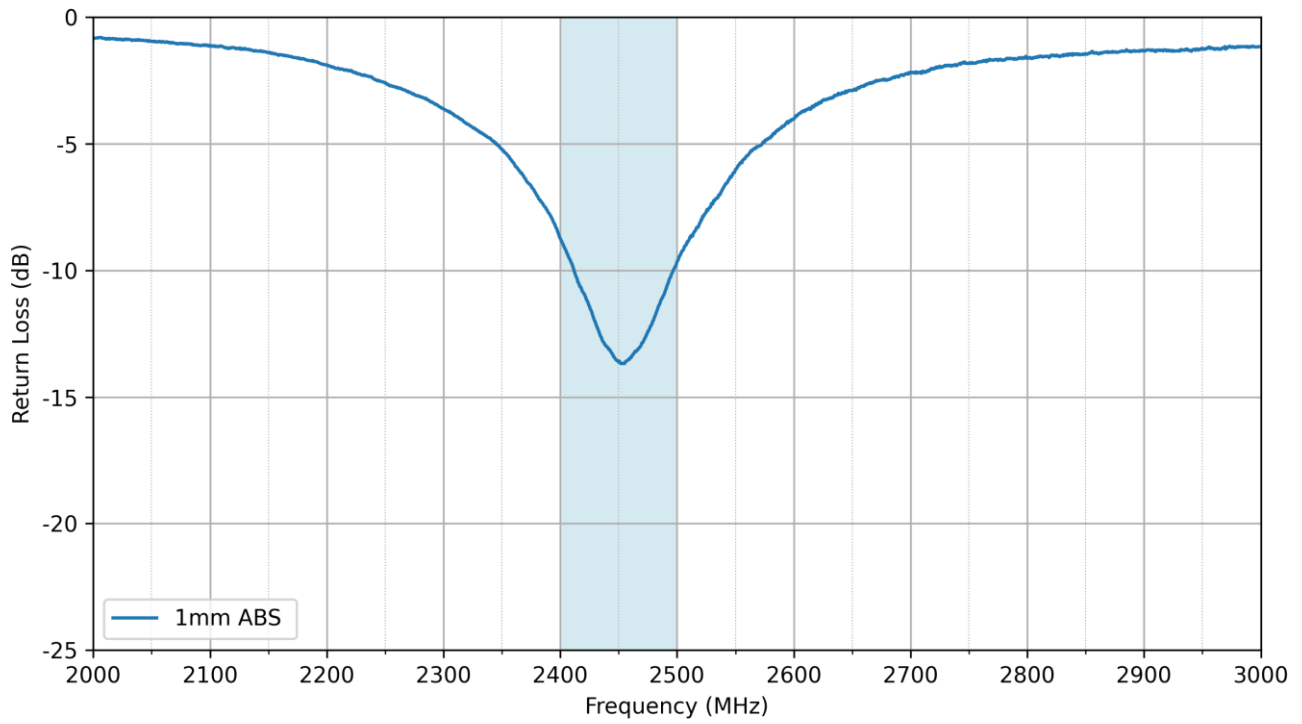

3.3 VSWR

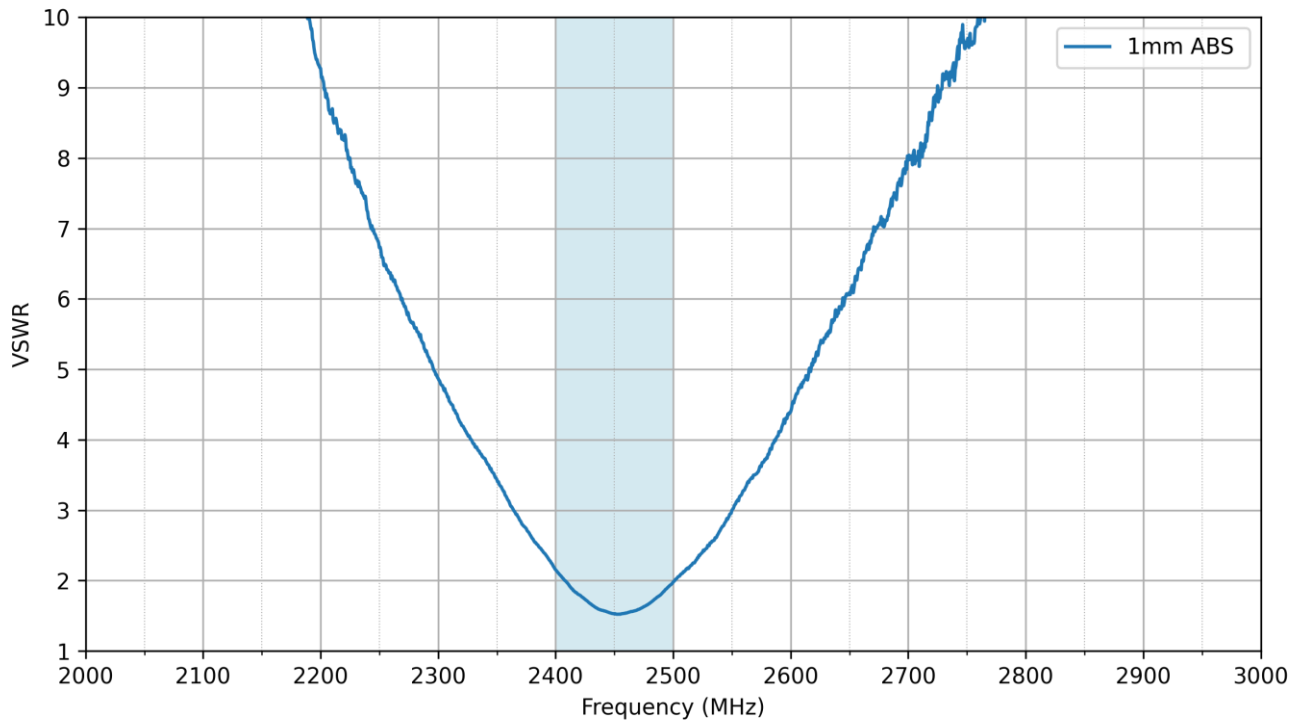

3.4 Efficiency

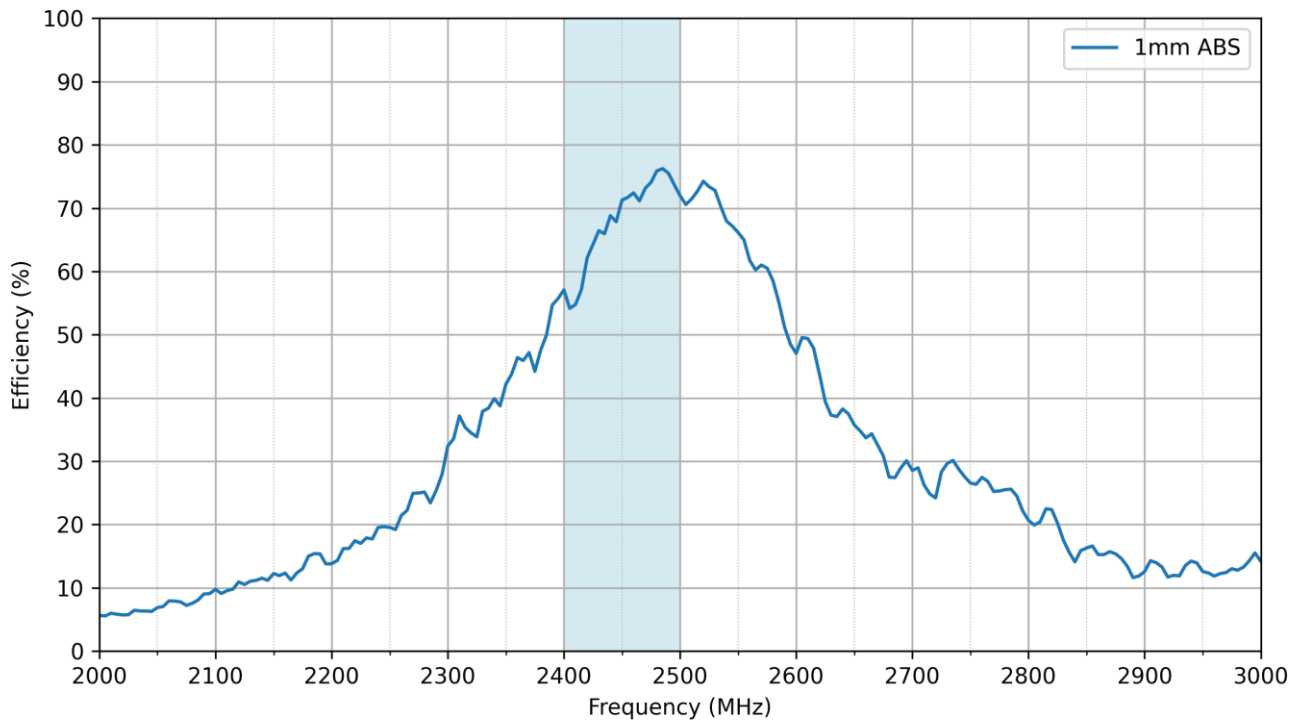

3.5 Average Gain

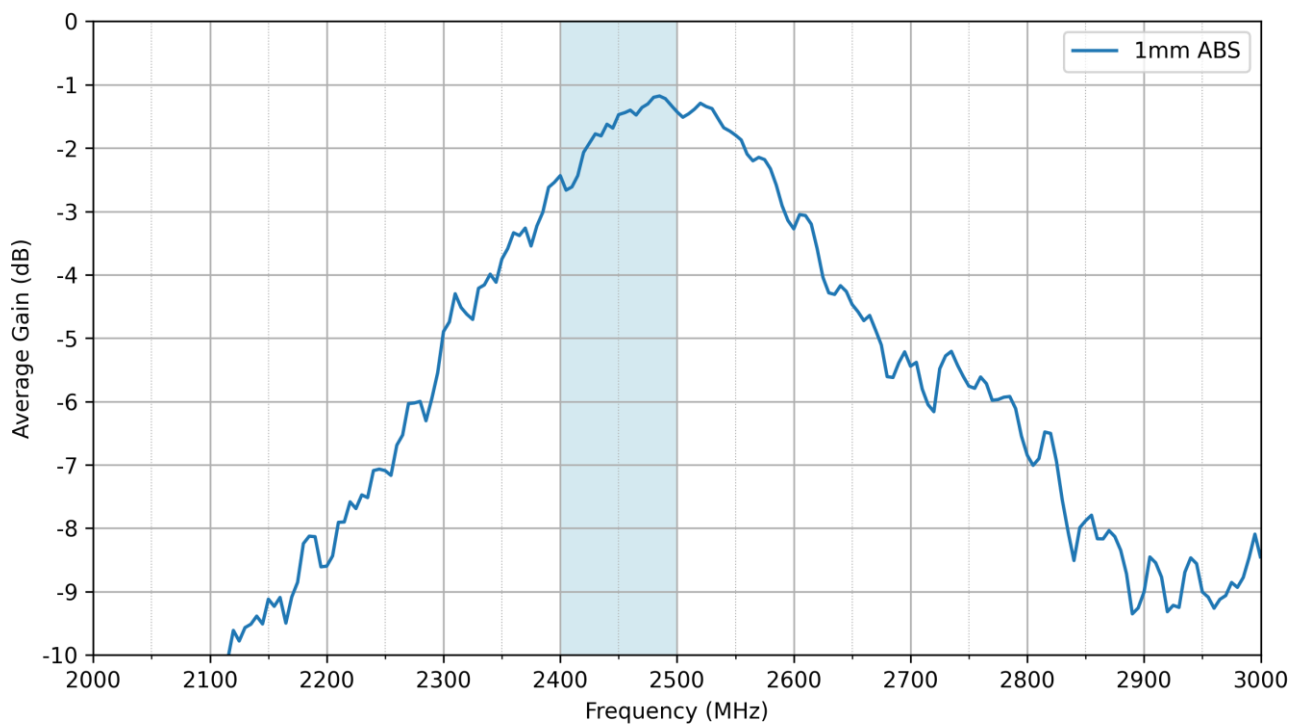

3.6 Peak Gain

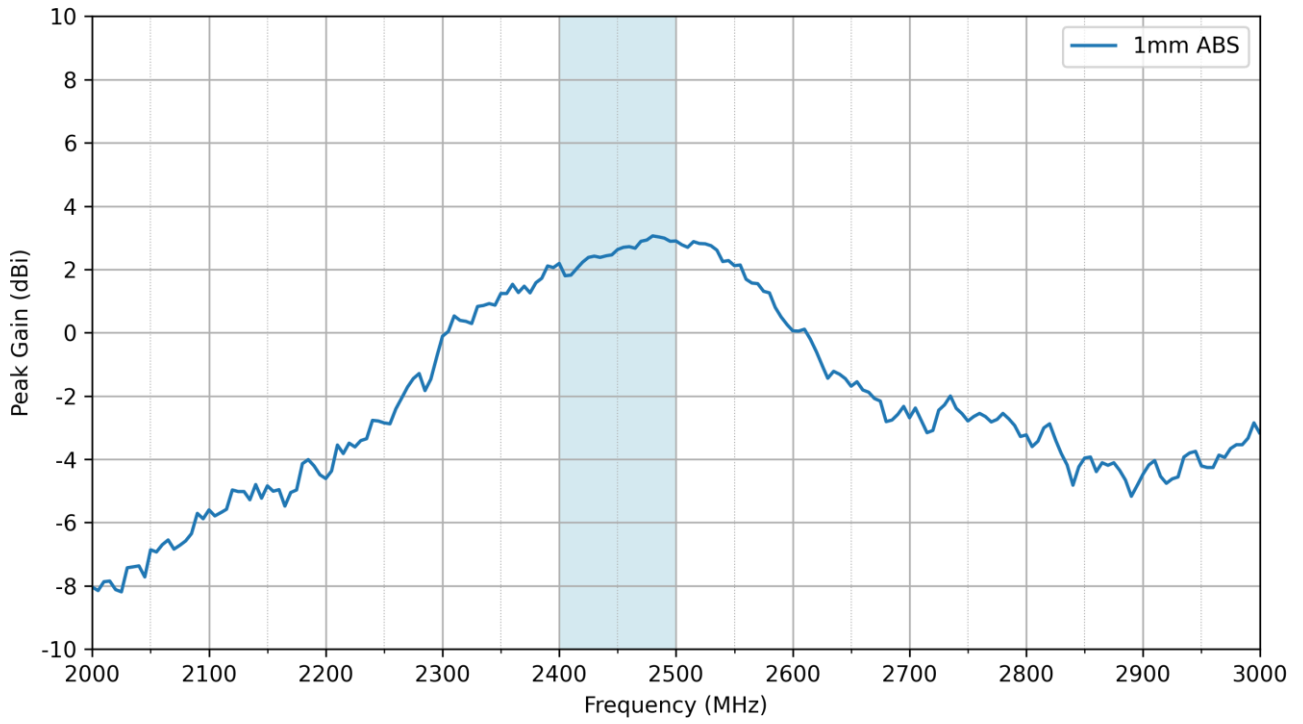

4. Radiation Patterns

4.1 Test Setup

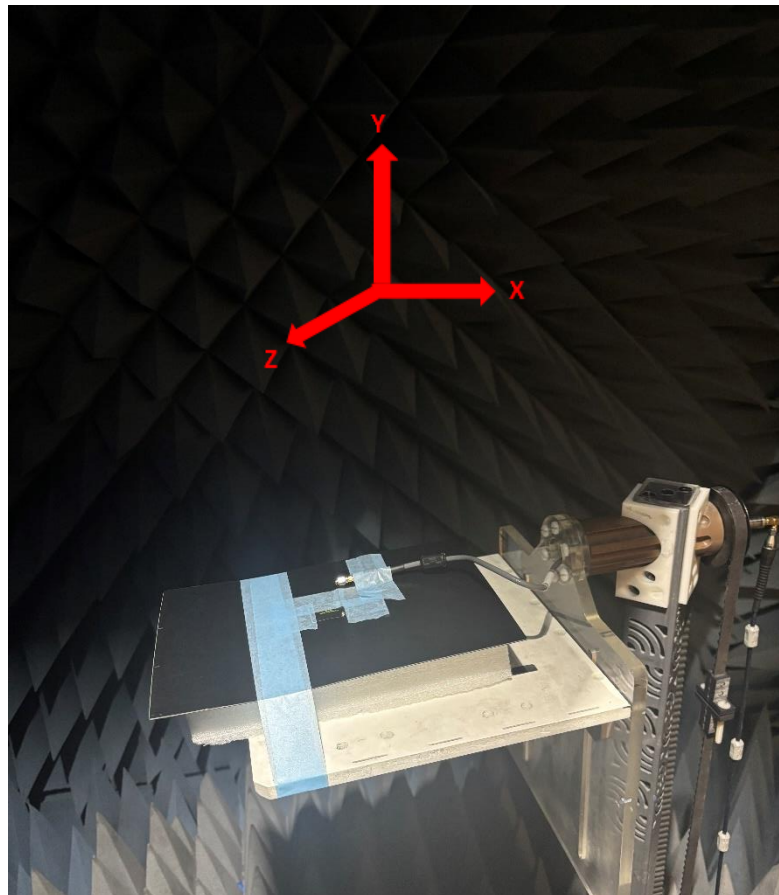
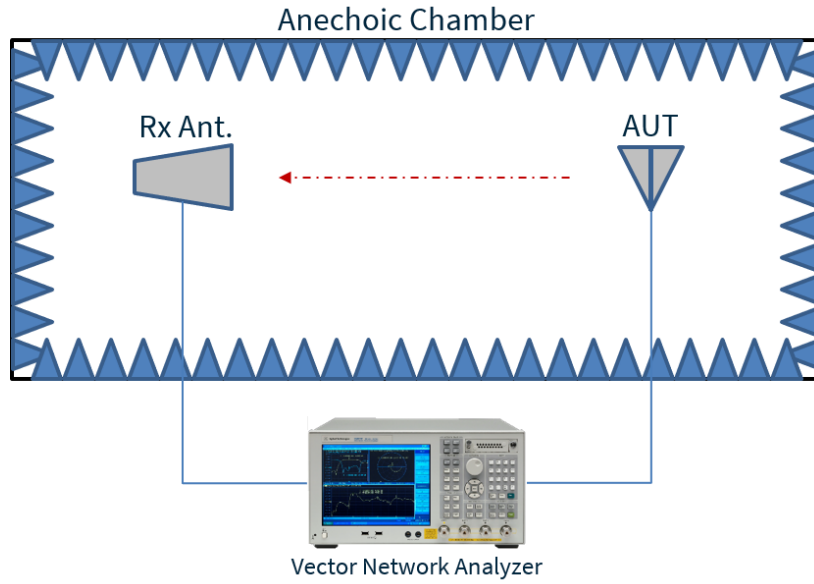

Chamber Test Set-up on 1mm ABS

4.2 1mm ABS Patterns at 2400 MHz

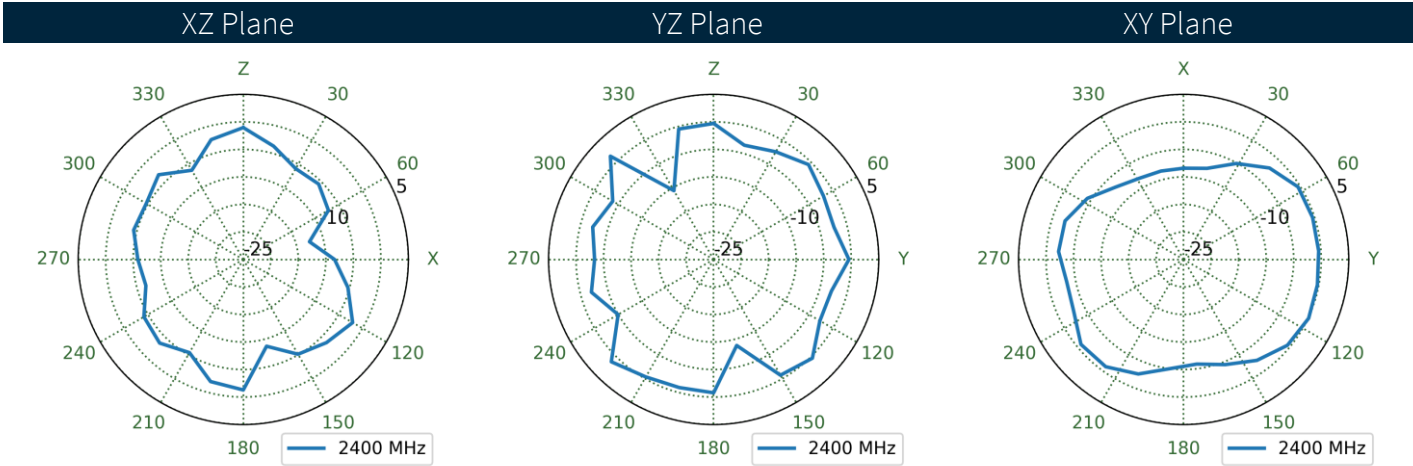
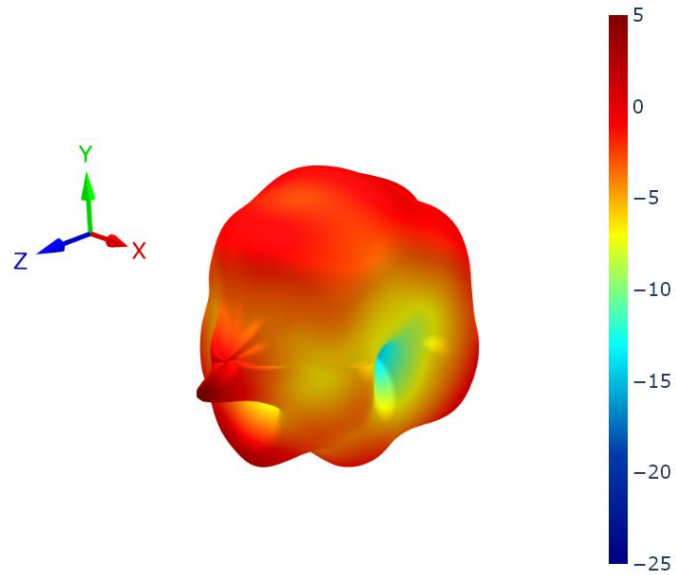

4.3 1mm ABS Patterns at 2450 MHz

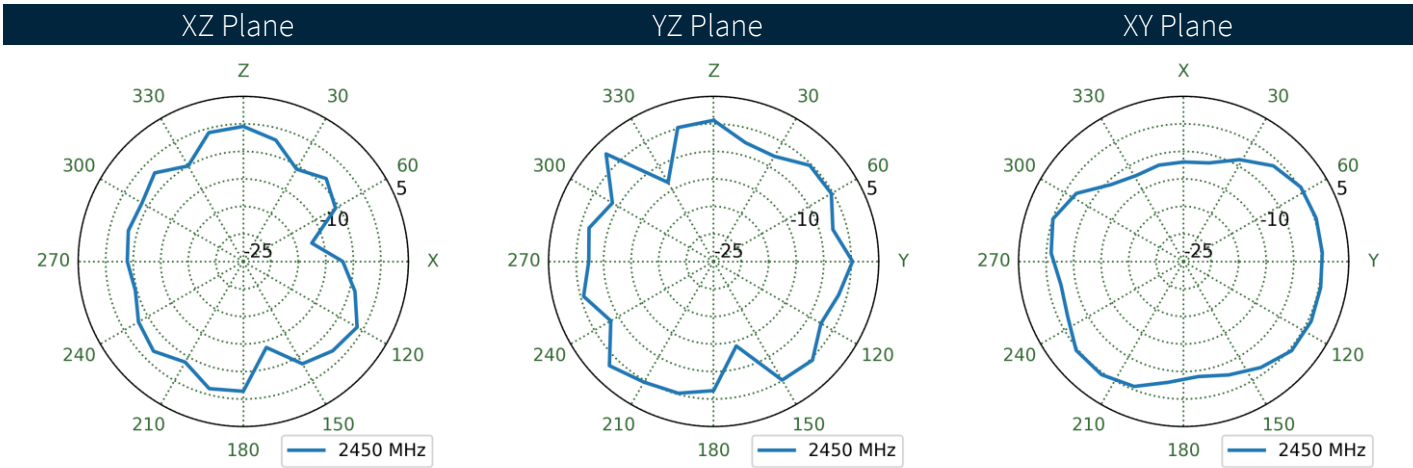
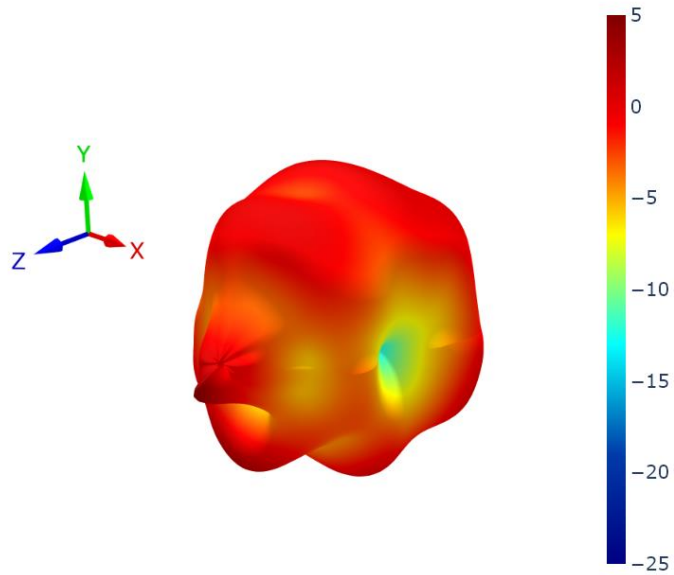

4.4 1mm ABS Patterns at 2500 MHz

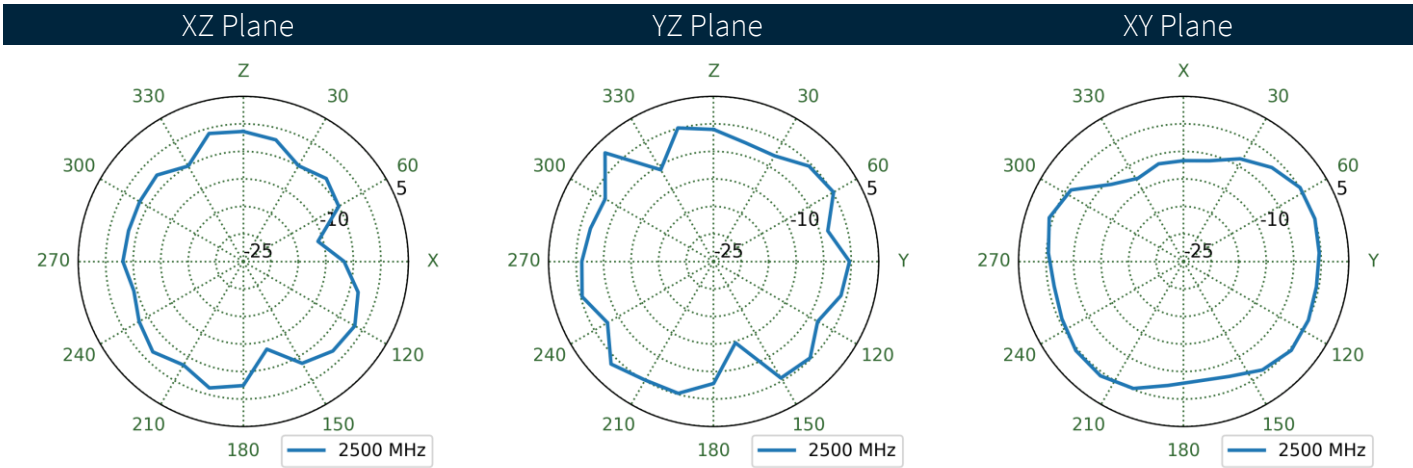
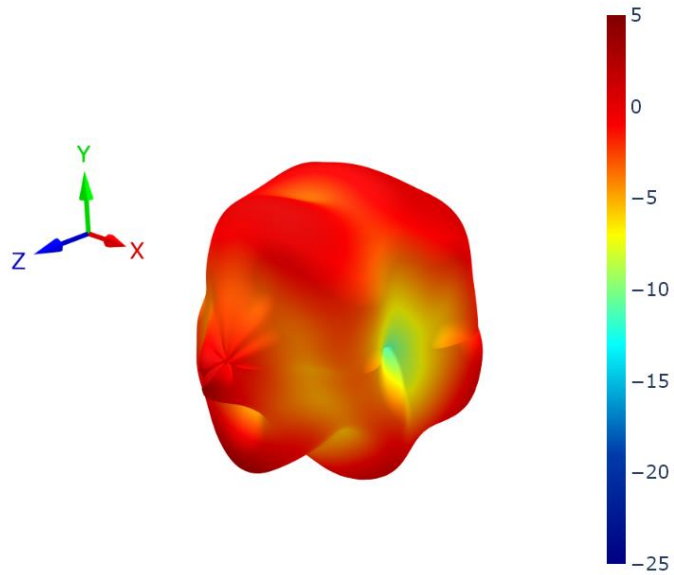

5. Mechanical Drawing

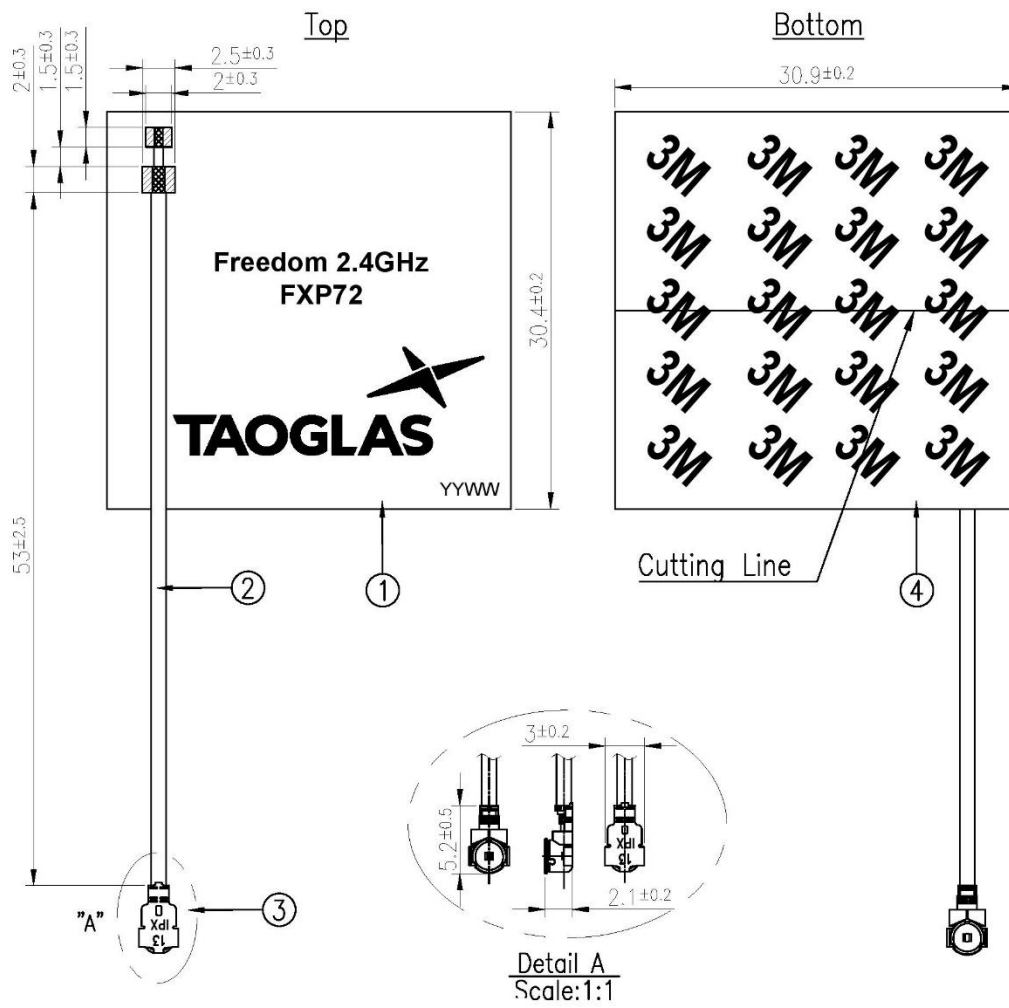

	Name	Material	Finish	QTY
1	FXP72 FPCB	Polymer 0.24t	Black	1
2	1.13 Coaxial Cable	FEP	Black	1
3	IPEX MHF1	Brass	Au Plated	1
4	Double Side Adhesive	3M 467	Brown Liner	1

6. Mounting Guidelines

This versatile antenna design is suitable for cases where there is not enough space for a thicker antenna. FXP72 can be right next to the device main board. This antenna uses the device main board as a ground plane through a capacitive coupling effect and keeping antenna characteristics.

The only restriction for this design is the radiated elements of the antenna must be free of metal. In the next figure 12 is shown the minimum clearance necessary for the antenna and on Figure 13 the non-desired main board shape on the antenna section. The size of the ground plane used on the testing is 40X60 mm and was allocated as in figure 12.

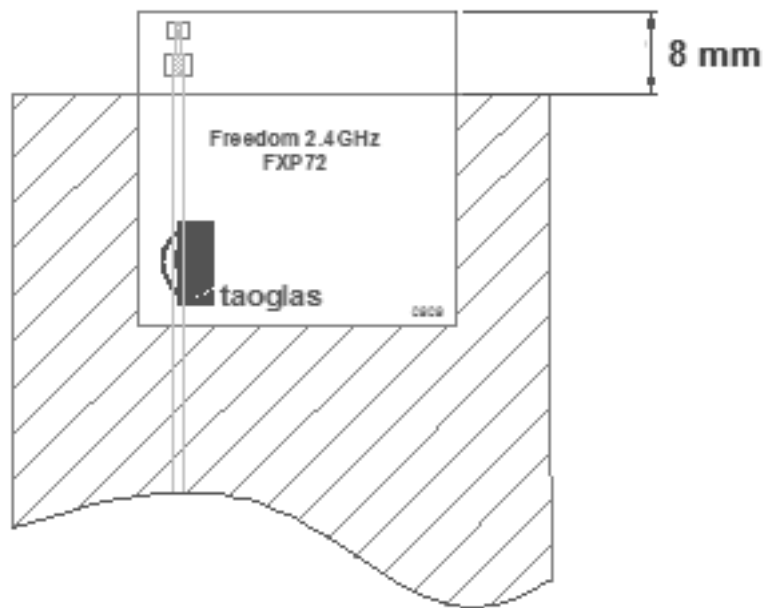

Figure 12

The size and shape of the ground plane can change. The only restrictions to get maximum performance are that the antenna must be allocated along the shortest edge of the device board, and the ground plane on that edge must have a flat shape horizontally, in order words the ground plane cannot come around of the antenna sides on that section.

The next figure 13 shows a non-desired ground plane environment.

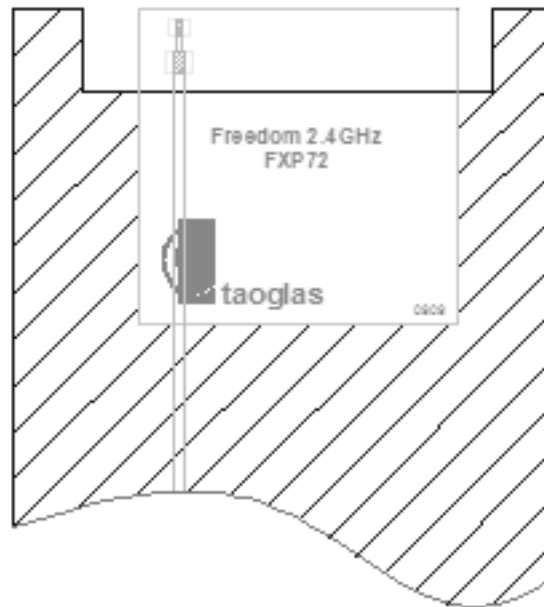

Figure 13

The size of the ground plane used on the testing had a dimension of 40X60 mm, see next figure 14. The antenna was placed in the center of one shortest edge. The antenna was in between the ABS plastic and ground plane, having a clearance of 8 mm. The Antenna was tested into the Satimo system chamber and with a network analyzer. The antenna was also tested on in free space, just the antenna stuck out on the ABS plastic of 1.5 mm of thickness.

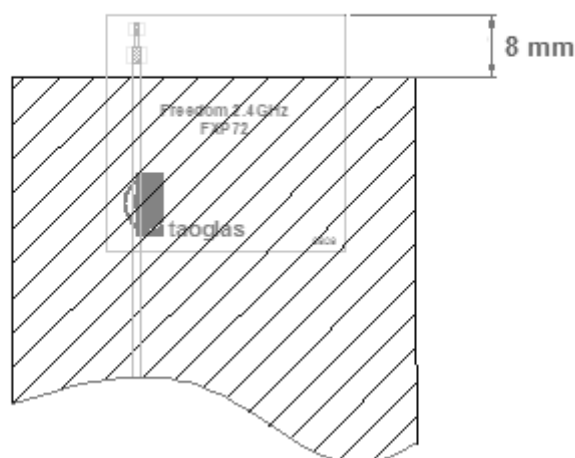
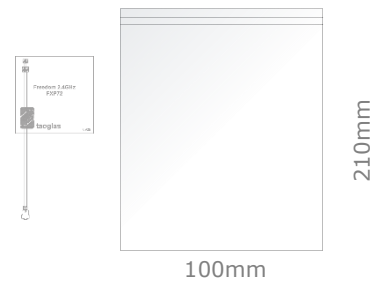

Figure 14

7. Packaging

100pc FXP72.07.0053A per Small PE Bag
 Dimensions: 210*100mm
 Weight: 130g



1000pcs FXP72.07.0053A per Large PE Bag
 Dimensions: 430*280mm
 Weight: 1.3Kg



2000pcs FXP72.07.0053A per Carton
 Carton Dimensions: 330*190*190 mm
 Weight: 2.6Kg

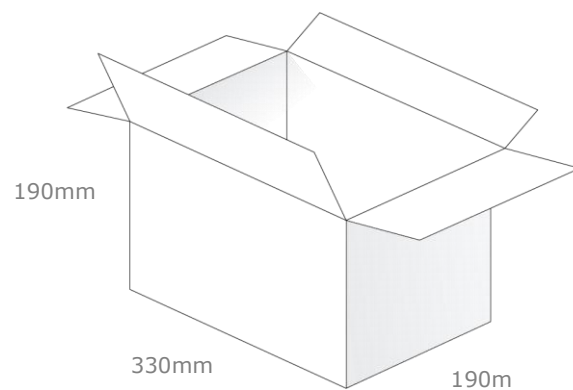

Pallet Dimensions:
 1200*1000*1340mm
 108 Cartons per Pallet
 18 Cartons per layer, 6 Layers

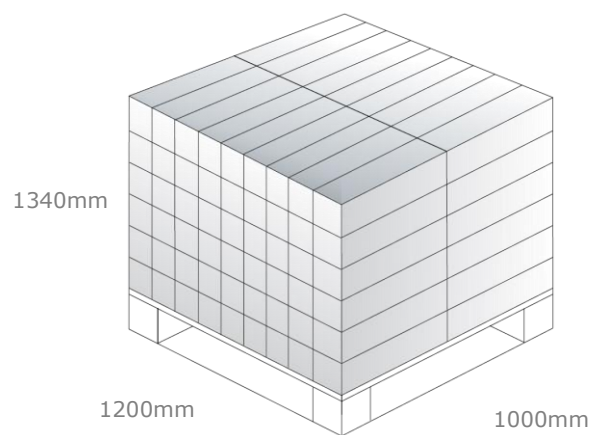

Changelog for the datasheet

SPE-12-8-012 - FXP72.07.0053A

Revision: G (Current Version)

Date:	2025-02-28
Changes:	Antenna retested, datasheet updated with new data, EDW and updated product image.
Changes Made by:	Gary West

Previous Revisions

Revision: F

Date:	2019-12-13
Changes:	Updated with new data
Changes Made by:	Jack Conroy

Revision: A (Original First Release)

Date:	2012-06-02
Notes:	
Author:	Aine Doyle

Revision: E

Date:	2019-08-28
Changes:	Packaging
Changes Made by:	Russell Meyler

Revision: D

Date:	2015-08-20
Changes:	Added note on Gain
Changes Made by:	Aine Doyle

Revision: C

Date:	2015-01-14
Changes:	Updated Intro
Changes Made by:	Andy Mahoney

Revision: B

Date:	2015-01-13
Changes:	Packaging Details Updated
Changes Made by:	Andy Mahoney



www.taoglas.com



Looking for pricing, stock, or lifecycle information?

Click below to explore more details on WIN SOURCE:

 [View FXP72.07.0053A on WIN SOURCE](#)

 [Taoglas Limited](#) Information

Optimize Your Supply Chain with WIN SOURCE Solutions

-  Global Sourcing Solution
-  Obsolete Management
-  Cost Control Management
-  Shortage Management
-  Alternative Solution
-  Excess Inventory Management