



**THE DATASHEET OF
C317C102J1G5TA7301**



Goldmax, 300 Series, Conformally Coated, COG Dielectric, 25 – 250 VDC (Commercial Grade)

Overview

KEMET's Goldmax conformally coated radial leaded ceramic capacitors in COG dielectric feature a 125°C maximum operating temperature. The Electronics Industries Alliance (EIA) characterizes COG dielectric as a Class I "stable" material. Components of this classification are temperature compensating and are suited for resonant circuit applications or those where Q and stability of capacitance characteristics are required. COG exhibits no change in capacitance with

respect to time and voltage and boasts a negligible change in capacitance with reference to ambient temperature. Capacitance change is limited to ± 30 ppm/°C from -55°C to +125°C.

These devices meet the flame test requirements outlined in UL Standard 94V-0.

Benefits

- Radial leaded form factor
- Conformally coated
- 0.100", 0.200", 0.250" and 0.400" lead spacing
- Operating temperature range of -55°C to +125°C
- Lead (Pb)-Free, RoHS and REACH compliant
- DC voltage ratings of 25 V, 50 V, 100 V, 200 V and 250 V
- Capacitance offerings ranging from 1.0 pF up to 0.47 μ F



Ordering Information

| C | 320 | | | C | 153 | J | 5 | G | 5 | T | A | 7301 |
|---------|------------|-----|-----|--------------------------|--|---|---|------------|-------------------|---|-----------------|---|
| Ceramic | Style/Size | | | Specification/ Series | Capacitance Code (pF) | Capacitance Tolerance ¹ | Rated Voltage (VDC) | Dielectric | Design | Lead Finish ² | Failure Rate | Packaging (C-Spec) |
| | 315 | 324 | 335 | C = Standard | First two digits represent significant figures. Third digit specifies number of zeros. | D = ± 0.5 pF F = $\pm 1\%$ G = $\pm 2\%$ J = $\pm 5\%$ K = $\pm 10\%$ | 3 = 25 5 = 50 1 = 100 2 = 200 A = 250 | G = COG | 5 = Multilayer | T = 100% Matte Sn H = SnPb (60/40) | A = N/A | See "Packaging C-Spec Ordering Options Table" below |
| | 316 | 325 | 336 | | | | | | | | | |
| | 317 | 326 | 340 | | | | | | | | | |
| | 318 | 327 | 346 | | | | | | | | | |
| | 320 | 328 | 350 | | | | | | | | | |
| | 321 | 330 | 356 | | | | | | | | | |
| | 322 | 331 | | | | | | | | | | |
| | 323 | 333 | | | | | | | | | | |

¹ Additional capacitance tolerance offerings may be available. Contact KEMET for details.

² Lead materials:

Standard: 100% matte tin (Sn) with nickel (Ni) underplate and steel core ("T" designation).

Alternative 1: 60% tin (Sn)/40% lead (Pb) finish with copper-clad steel core ("H" designation).

Alternative 2: 60% tin (Sn)/40% lead (Pb) finish with 100% copper core (available with "H" designation code with C-Spec). Contact KEMET for C-Spec details.

Built Into Tomorrow

Benefits cont.

- Available capacitance Tolerances of ± 0.5 pF, $\pm 1\%$, $\pm 2\%$, $\pm 5\%$, and $\pm 10\%$
- Extremely low ESR and ESL
- High thermal stability
- High ripple current capability
- No capacitance change with respect to applied rated DC voltage
- Negligible capacitance change with respect to temperature from -55°C to $+125^{\circ}\text{C}$
- No capacitance decay with time
- Non-polar device, minimizing installation concerns
- 100% pure matte tin-plated lead finish allowing for excellent solderability
- SnPb-plated lead finish option available upon request (Sn60/Pb40)
- Encapsulation meets flammability standard UL 94V-0

Applications

Typical applications include critical timing, tuning, circuits requiring low loss, circuits with pulse, high current, decoupling, bypass, filtering, transient voltage suppression, blocking and energy storage.

Application Notes

These devices are not recommended for use in overmold applications and/or processes.

Packaging C-Spec Ordering Options Table

| Packaging Type ¹ | Packaging/Grade Ordering Code (C-Spec) |
|---|--|
| Bulk Bag | Not required (Blank) |
| 12" Tape & Reel (16.0 \pm 0.5 mm lead length) | 7301 |
| 12" Tape & Reel (18.0 mm minimum lead length) | 7303 and TR |
| Ammo Pack (16.0 \pm 0.5 mm lead length) | 7305 |
| Ammo Pack (18.0 mm minimum lead length) | 7317 |

¹ Default packaging is "Bulk Bag". An ordering code C-Spec is not required for "Bulk Bag" packaging. Bulk bag option is required for Size/Style C321 and C331.

¹ "Tape and Reel" packaging option is not available for Size/Style C321 and C331. For more information see "Packaging Quantities".

¹ "Ammo Pack" packaging option is not available for Size/Style C321, C331, C350, and C356. For more information see "Packaging Quantities".

¹ "Ammo Pack" and "Tape and Reel" packaging options have the same lead tape configuration. For more information see "Tape & Reel Packaging Information".

Dimensions – Inches (Millimeters)

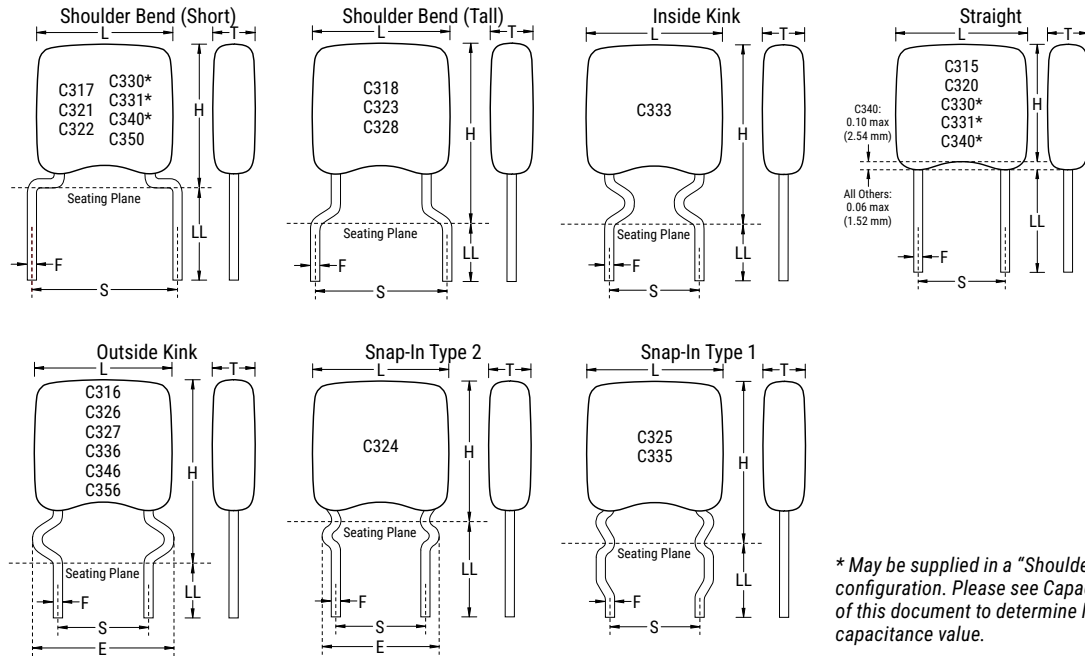

* May be supplied in a "Shoulder Bend" or "Straight" Lead configuration. Please see Capacitance Range Waterfall section of this document to determine lead configuration availability by capacitance value.

| Series | Style / Size | S Lead Spacing ±0.030 (0.78) | L Length Maximum | H Height Maximum | T Thickness Maximum | F Lead Diameter +0.004 (0.10), -0.001 (0.025) | LL Lead Length Minimum |
|--------|--------------|---------------------------------|------------------|---------------------------|---------------------------|---|------------------------|
| C31X | 315 | 0.100 (2.54) | 0.150 (3.81) | 0.120 (3.14) | 0.100 (2.54) | 0.020 (0.51) | 0.276 (7.00) |
| | 316 | | 0.150 (3.81) | 0.230 (5.84) | 0.100 (2.54) | | 0.200 (5.08) |
| C32X | 324 | 0.100 (2.54) | 0.200 (5.08) | 0.230 (5.84) | 0.125 (3.18) ¹ | | 0.276 (7.00) |
| | 320 | | 0.200 (5.08) | 0.230 (5.84) | 0.125 (3.18) ¹ | | 0.276 (7.00) |
| C32X | 326 | 0.200 (5.08) | 0.200 (5.08) | 0.300 (7.62) | 0.125 (3.18) ¹ | | 0.200 (5.08) |
| | 317 | | 0.150 (3.81) | 0.200 (5.08) | 0.100 (2.54) | | 0.276 (7.00) |
| C31X | 318 | 0.200 (5.08) | 0.150 (3.81) | 0.235 (5.97) | 0.100 (2.54) | | 0.276 (7.00) |
| | 321 | | 0.200 (5.08) | 0.260 (6.60) | 0.125 (3.18) ¹ | | 0.276 (7.00) |
| C32X | 322 | 0.200 (5.08) | 0.200 (5.08) | 0.260 (6.60) | 0.125 (3.18) ¹ | | 0.276 (7.00) |
| | 323 | | 0.200 (5.08) | 0.300 (7.62) | 0.125 (3.18) ¹ | | 0.276 (7.00) |
| | 325 | | 0.200 (5.08) | 0.300 (7.62) | 0.125 (3.18) ¹ | 0.276 (7.00) | |
| | 328 | | 0.200 (5.08) | 0.300 (7.62) | 0.125 (3.18) ¹ | 0.276 (7.00) | |
| | 327 | | 0.200 (5.08) | 0.320 (8.13) | 0.125 (3.18) ¹ | 0.200 (5.08) | |
| C33X | 330 | 0.250 (6.35) | 0.280 (7.11) | 0.360 (9.14) ² | 0.160 (4.07) | 0.276 (7.00) | |
| | 331 | | 0.300 (7.62) | 0.360 (9.14) ² | 0.160 (4.07) | 0.276 (7.00) | |
| | 333 | | 0.280 (7.11) | 0.400 (10.16) | 0.160 (4.07) | 0.276 (7.00) | |
| | 335 | | 0.280 (7.11) | 0.400 (10.16) | 0.160 (4.07) | 0.276 (7.00) | |
| | 336 | | 0.280 (7.11) | 0.400 (10.16) | 0.160 (4.07) | 0.200 (5.08) | |
| C34X | 340 | 0.200 (5.08) | 0.290 (7.36) | 0.400 (10.16) | 0.160 (4.07) | 0.276 (7.00) | |
| | 346 | | 0.290 (7.36) | 0.400 (10.16) | 0.160 (4.07) | 0.200 (5.08) | |
| C35X | 350 | 0.400 (10.16) | 0.330 (8.38) | 0.400 (10.16) | 0.200 (5.08) | 0.276 (7.00) | |
| | 356 | | 0.330 (8.38) | 0.400 (10.16) | 0.200 (5.08) | 0.200 (5.08) | |

¹ Thickness maximum (T) = 0.160" (4.07 mm) for capacitance values greater than or equal to 4.7 µF

² Height max. (H) = 0.400" (10.16 mm) for C330 & C331 with shoulder bend leads (see capacitance range waterfall table).

Qualification/Certification

Commercial Grade products are subject to internal qualification. Details regarding test methods and conditions are referenced in Table 2, Performance & Reliability.

Environmental Compliance

Lead (Pb)-free, REACH and RoHS compliant without exemptions when ordered with a 100% tin (Sn) wire lead finish. Product ordered with tin/ lead (Sn60/Pb40) wire lead finish do not meet RoHS criteria.

| Series | Termination Finish (Wire Lead) | RoHS Compliant | RoHS Exemption Code | REACH Compliant ¹ | Halogen Free |
|------------|--------------------------------|----------------|---------------------|------------------------------|--------------|
| 300 (C3XX) | 100% Matte Sn | Yes | n/a | Yes | Yes |
| | Sn60/Pb40 | No | n/a | Yes | Yes |

¹ REACH compliance indicates product does not contain Substance/s of Very High Concern (SVHC)

Electrical Parameters/Characteristics

| Item | Parameters/Characteristics |
|--|---|
| Operating Temperature Range | -55°C to +125°C |
| Capacitance Change with Reference to +25°C and 0 VDC Applied (TCC) | ±30 ppm/°C |
| Aging Rate (Maximum % Cap Loss/Decade Hour) | 0% |
| Dielectric Withstanding Voltage | 250% of rated voltage (5±1 second and charge/discharge not exceeding 50 mA at 25°C) |
| Dissipation Factor (DF) Maximum Limit at 25°C | 0.1% |
| Insulation Resistance (IR) Limit at 25°C | 1,000 megohm microfarads or 100 GΩ (Rated voltage applied for 120±5 seconds at 25°C) |

To obtain IR limit, divide MQ-μF value by the capacitance and compare to GΩ limit. Select the lower of the two limits.

Capacitance and dissipation factor (DF) measured under the following conditions:

1 MHz ±100 kHz and 1.0 V_{rms} ±0.2 V if capacitance ≤ 1,000 pF

1 kHz ±50 Hz and 1.0 V_{rms} ±0.2 V if capacitance > 1,000 pF

Note: When measuring capacitance it is important to ensure the set voltage level is held constant. The HP4284 and Agilent E4980 have a feature known as Automatic Level Control (ALC). The ALC feature should be switched to "ON."

Post Environmental Limits

| High Temperature Life, Biased Humidity and Storage Life | | | | | |
|---|------------------|-------------------|--------------------------------|-------------------|-----------------------|
| Style/Size | Rated DC Voltage | Capacitance Value | Dissipation Factor (Maximum %) | Capacitance Shift | Insulation Resistance |
| COG | All | All | 0.5 | 0.3% or ±0.25 pF | 10% of Initial Limit |

Table 1A – C31X Style/Size, Capacitance Range Waterfall

| C315, C316, C317, C318 Style/Size (0.100" and 0.200" Lead Spacing) | | | | | | |
|--|---|--|-----|-----|-----|-----|
| Rated Voltage (VDC) | | 25 | 50 | 100 | 200 | 250 |
| Voltage Code | | 3 | 5 | 1 | 2 | A |
| Capacitance | Capacitance Tolerance | Capacitance Code (Available Capacitance) | | | | |
| 1pF | D = ±0.5pF | 109 | 109 | 109 | 109 | 109 |
| 1.1pF | | 119 | 119 | 119 | 119 | 119 |
| 1.2pF | | 129 | 129 | 129 | 129 | 129 |
| 1.3pF | | 139 | 139 | 139 | 139 | 139 |
| 1.5pF | | 159 | 159 | 159 | 159 | 159 |
| 1.6pF | | 169 | 169 | 169 | 169 | 169 |
| 1.8pF | | 189 | 189 | 189 | 189 | 189 |
| 2.0pF | | 209 | 209 | 209 | 209 | 209 |
| 2.2pF | | 229 | 229 | 229 | 229 | 229 |
| 2.4pF | | 249 | 249 | 249 | 249 | 249 |
| 2.7pF | | 279 | 279 | 279 | 279 | 279 |
| 3.0pF | | 309 | 309 | 309 | 309 | 309 |
| 3.3pF | | 339 | 339 | 339 | 339 | 339 |
| 3.6pF | | 369 | 369 | 369 | 369 | 369 |
| 3.9pF | | 399 | 399 | 399 | 399 | 399 |
| 4.3pF | | 439 | 439 | 439 | 439 | 439 |
| 4.7pF | | 479 | 479 | 479 | 479 | 479 |
| 5.1pF | | 519 | 519 | 519 | 519 | 519 |
| 5.6pF | | 569 | 569 | 569 | 569 | 569 |
| 6.2pF | | 629 | 629 | 629 | 629 | 629 |
| 6.8pF | 689 | 689 | 689 | 689 | 689 | |
| 7.5pF | 759 | 759 | 759 | 759 | 759 | |
| 8.2pF | 829 | 829 | 829 | 829 | 829 | |
| 9.1pF | 919 | 919 | 919 | 919 | 919 | |
| 10pF | F = ±1% G = ±2% J = ±5% K = ±10% | 100 | 100 | 100 | 100 | 100 |
| 11pF | | 110 | 110 | 110 | 110 | 110 |
| 12pF | | 120 | 120 | 120 | 120 | 120 |
| 13pF | | 130 | 130 | 130 | 130 | 130 |
| 15pF | | 150 | 150 | 150 | 150 | 150 |
| 16pF | | 160 | 160 | 160 | 160 | 160 |
| 18pF | | 180 | 180 | 180 | 180 | 180 |
| 20pF | | 200 | 200 | 200 | 200 | 200 |
| 22pF | | 220 | 220 | 220 | 220 | 220 |
| 24pF | | 240 | 240 | 240 | 240 | 240 |
| 27pF | | 270 | 270 | 270 | 270 | 270 |
| 30pF | | 300 | 300 | 300 | 300 | 300 |
| 33pF | | 330 | 330 | 330 | 330 | 330 |
| 36pF | | 360 | 360 | 360 | 360 | 360 |
| 39pF | | 390 | 390 | 390 | 390 | 390 |
| 43pF | | 430 | 430 | 430 | 430 | 430 |
| 47pF | | 470 | 470 | 470 | 470 | 470 |
| 51pF | | 510 | 510 | 510 | 510 | 510 |
| 56pF | | 560 | 560 | 560 | 560 | 560 |
| 62pF | | 620 | 620 | 620 | 620 | 620 |
| 68pF | 680 | 680 | 680 | 680 | 680 | |
| 75pF | 750 | 750 | 750 | 750 | 750 | |
| 82pF | 820 | 820 | 820 | 820 | 820 | |
| 91pF | 910 | 910 | 910 | 910 | 910 | |
| 100pF | 101 | 101 | 101 | 101 | 101 | |
| 110pF | 111 | 111 | 111 | 111 | 111 | |
| 120pF | 121 | 121 | 121 | 121 | 121 | |
| 130pF | 131 | 131 | 131 | 131 | 131 | |
| 150pF | 151 | 151 | 151 | 151 | 151 | |
| 160pF | 161 | 161 | 161 | 161 | 161 | |
| 180pF | 181 | 181 | 181 | 181 | 181 | |
| 200pF | 201 | 201 | 201 | 201 | 201 | |
| Rated Voltage (VDC) | | 25 | 50 | 100 | 200 | 250 |
| Voltage Code | | 3 | 5 | 1 | 2 | A |

These products are protected under one or more of the following United States Patents and their non-US counterparts: US Pat. No. 7172985; U.S. Pat. No. 7670981.

Table 1A – C31X Style/Size, Capacitance Range Waterfall cont.

| C315, C316, C317, C318 Style/Size (0.100" and 0.200" Lead Spacing) | | | | | | |
|--|---|--|-----|-----|-----|-----|
| Rated Voltage (VDC) | | 25 | 50 | 100 | 200 | 250 |
| Voltage Code | | 3 | 5 | 1 | 2 | A |
| Capacitance | Capacitance Tolerance | Capacitance Code (Available Capacitance) | | | | |
| 220pF | F = ±1% G = ±2% J = ±5% K = ±10% | 221 | 221 | 221 | 221 | 221 |
| 240pF | | 241 | 241 | 241 | 241 | 241 |
| 270pF | | 271 | 271 | 271 | 271 | 271 |
| 300pF | | 301 | 301 | 301 | 301 | 301 |
| 330pF | | 331 | 331 | 331 | 331 | 331 |
| 360pF | | 361 | 361 | 361 | 361 | 361 |
| 390pF | | 391 | 391 | 391 | 391 | 391 |
| 430pF | | 431 | 431 | 431 | 431 | 431 |
| 470pF | | 471 | 471 | 471 | 471 | 471 |
| 510pF | | 511 | 511 | 511 | 511 | 511 |
| 560pF | | 561 | 561 | 561 | 561 | 561 |
| 620pF | | 621 | 621 | 621 | 621 | 621 |
| 680pF | | 681 | 681 | 681 | 681 | 681 |
| 750pF | | 751 | 751 | 751 | 751 | 751 |
| 820pF | | 821 | 821 | 821 | 821 | 821 |
| 910pF | | 911 | 911 | 911 | 911 | 911 |
| 1000pF | | 102 | 102 | 102 | 102 | 102 |
| 1100pF | | 112 | 112 | 112 | 112 | 112 |
| 1200pF | | 122 | 122 | 122 | 122 | 122 |
| 1300pF | | 132 | 132 | 132 | 132 | 132 |
| 1500pF | | 152 | 152 | 152 | 152 | 152 |
| 1600pF | | 162 | 162 | 162 | 162 | 162 |
| 1800pF | | 182 | 182 | 182 | 182 | 182 |
| 2000pF | | 202 | 202 | 202 | 202 | 202 |
| 2200pF | | 222 | 222 | 222 | 222 | 222 |
| 2400pF | | 242 | 242 | 242 | 242 | 242 |
| 2700pF | | 272 | 272 | 272 | 272 | 272 |
| 3000pF | | 302 | 302 | 302 | 302 | 302 |
| 3300pF | | 332 | 332 | 332 | 332 | 332 |
| 3600pF | | 362 | 362 | 362 | 362 | 362 |
| 3900pF | | 392 | 392 | 392 | 392 | 392 |
| 4300pF | | 432 | 432 | 432 | 432 | 432 |
| 4700pF | | 472 | 472 | 472 | 472 | 472 |
| 5100pF | | 512 | 512 | 512 | 512 | 512 |
| 5600pF | | 562 | 562 | 562 | 562 | 562 |
| 6200pF | | 622 | 622 | 622 | 622 | 622 |
| 6800pF | | 682 | 682 | 682 | 682 | 682 |
| 7500pF | | 752 | 752 | 752 | 752 | 752 |
| 8200pF | | 822 | 822 | 822 | 822 | 822 |
| 9100pF | | 912 | 912 | 912 | | |
| 0.01µF | | 103 | 103 | 103 | | |
| 0.012µF | | 123 | 123 | 123 | | |
| 0.015µF | | 153 | 153 | 153 | | |
| 0.018µF | | 183 | 183 | | | |
| 0.022µF | | 223 | 223 | | | |
| 0.027µF | | 273 | | | | |
| 0.033µF | | 333 | | | | |
| 0.039µF | 393 | | | | | |
| 0.047µF | 473 | | | | | |
| Rated Voltage (VDC) | | 25 | 50 | 100 | 200 | 250 |
| Voltage Code | | 3 | 5 | 1 | 2 | A |

These products are protected under one or more of the following United States Patents and their non-US counterparts: US Pat. No. 7172985; U.S. Pat. No. 7670981.

Table 1B – C32X Style/Size, Capacitance Range Waterfall

| C320, C322, C323, C326, C328 Style/Size (0.100" and 0.200" Lead Spacing) | | | | | | |
|--|---|--|-----|-----|-----|-----|
| Rated Voltage (VDC) | | 25 | 50 | 100 | 200 | 250 |
| Voltage Code | | 3 | 5 | 1 | 2 | A |
| Capacitance | Capacitance Tolerance | Capacitance Code (Available Capacitance) | | | | |
| 1pF | D = ±0.5pF | 109 | 109 | 109 | 109 | 109 |
| 1.1pF | | 119 | 119 | 119 | 119 | 119 |
| 1.2pF | | 129 | 129 | 129 | 129 | 129 |
| 1.3pF | | 139 | 139 | 139 | 139 | 139 |
| 1.5pF | | 159 | 159 | 159 | 159 | 159 |
| 1.6pF | | 169 | 169 | 169 | 169 | 169 |
| 1.8pF | | 189 | 189 | 189 | 189 | 189 |
| 2.0pF | | 209 | 209 | 209 | 209 | 209 |
| 2.2pF | | 229 | 229 | 229 | 229 | 229 |
| 2.4pF | | 249 | 249 | 249 | 249 | 249 |
| 2.7pF | | 279 | 279 | 279 | 279 | 279 |
| 3.0pF | | 309 | 309 | 309 | 309 | 309 |
| 3.3pF | | 339 | 339 | 339 | 339 | 339 |
| 3.6pF | | 369 | 369 | 369 | 369 | 369 |
| 3.9pF | | 399 | 399 | 399 | 399 | 399 |
| 4.3pF | | 439 | 439 | 439 | 439 | 439 |
| 4.7pF | | 479 | 479 | 479 | 479 | 479 |
| 5.1pF | | 519 | 519 | 519 | 519 | 519 |
| 5.6pF | | 569 | 569 | 569 | 569 | 569 |
| 6.2pF | | 629 | 629 | 629 | 629 | 629 |
| 6.8pF | 689 | 689 | 689 | 689 | 689 | |
| 7.5pF | 759 | 759 | 759 | 759 | 759 | |
| 8.2pF | 829 | 829 | 829 | 829 | 829 | |
| 9.1pF | 919 | 919 | 919 | 919 | 919 | |
| 10pF | F = ±1% G = ±2% J = ±5% K = ±10% | 100 | 100 | 100 | 100 | 100 |
| 11pF | | 110 | 110 | 110 | 110 | 110 |
| 12pF | | 120 | 120 | 120 | 120 | 120 |
| 13pF | | 130 | 130 | 130 | 130 | 130 |
| 15pF | | 150 | 150 | 150 | 150 | 150 |
| 16pF | | 160 | 160 | 160 | 160 | 160 |
| 18pF | | 180 | 180 | 180 | 180 | 180 |
| 20pF | | 200 | 200 | 200 | 200 | 200 |
| 22pF | | 220 | 220 | 220 | 220 | 220 |
| 24pF | | 240 | 240 | 240 | 240 | 240 |
| 27pF | | 270 | 270 | 270 | 270 | 270 |
| 30pF | | 300 | 300 | 300 | 300 | 300 |
| 33pF | | 330 | 330 | 330 | 330 | 330 |
| 36pF | | 360 | 360 | 360 | 360 | 360 |
| 39pF | | 390 | 390 | 390 | 390 | 390 |
| 43pF | | 430 | 430 | 430 | 430 | 430 |
| 47pF | | 470 | 470 | 470 | 470 | 470 |
| 51pF | | 510 | 510 | 510 | 510 | 510 |
| 56pF | | 560 | 560 | 560 | 560 | 560 |
| 62pF | | 620 | 620 | 620 | 620 | 620 |
| 68pF | 680 | 680 | 680 | 680 | 680 | |
| 75pF | 750 | 750 | 750 | 750 | 750 | |
| 82pF | 820 | 820 | 820 | 820 | 820 | |
| 91pF | 910 | 910 | 910 | 910 | 910 | |
| 100pF | 101 | 101 | 101 | 101 | 101 | |
| 110pF | 111 | 111 | 111 | 111 | 111 | |
| 120pF | 121 | 121 | 121 | 121 | 121 | |
| 130pF | 131 | 131 | 131 | 131 | 131 | |
| 150pF | 151 | 151 | 151 | 151 | 151 | |
| 160pF | 161 | 161 | 161 | 161 | 161 | |
| 180pF | 181 | 181 | 181 | 181 | 181 | |
| 200pF | 201 | 201 | 201 | 201 | 201 | |
| Rated Voltage (VDC) | | 25 | 50 | 100 | 200 | 250 |
| Voltage Code | | 3 | 5 | 1 | 2 | A |

These products are protected under one or more of the following United States Patents and their non-US counterparts: US Pat. No. 7172985; U.S. Pat. No. 7670981.

Table 1B – C32X Style/Size, Capacitance Range Waterfall cont.

| C320, C322, C323, C326, C328 Style/Size (0.100" and 0.200" Lead Spacing) | | | | | | |
|--|---|--|-----|-----|-----|-----|
| Rated Voltage (VDC) | | 25 | 50 | 100 | 200 | 250 |
| Voltage Code | | 3 | 5 | 1 | 2 | A |
| Capacitance | Capacitance Tolerance | Capacitance Code (Available Capacitance) | | | | |
| 220pF | F = ±1% G = ±2% J = ±5% K = ±10% | 221 | 221 | 221 | 221 | 221 |
| 240pF | | 241 | 241 | 241 | 241 | 241 |
| 270pF | | 271 | 271 | 271 | 271 | 271 |
| 300pF | | 301 | 301 | 301 | 301 | 301 |
| 330pF | | 331 | 331 | 331 | 331 | 331 |
| 360pF | | 361 | 361 | 361 | 361 | 361 |
| 390pF | | 391 | 391 | 391 | 391 | 391 |
| 430pF | | 431 | 431 | 431 | 431 | 431 |
| 470pF | | 471 | 471 | 471 | 471 | 471 |
| 510pF | | 511 | 511 | 511 | 511 | 511 |
| 560pF | | 561 | 561 | 561 | 561 | 561 |
| 620pF | | 621 | 621 | 621 | 621 | 621 |
| 680pF | | 681 | 681 | 681 | 681 | 681 |
| 750pF | | 751 | 751 | 751 | 751 | 751 |
| 820pF | | 821 | 821 | 821 | 821 | 821 |
| 910pF | | 911 | 911 | 911 | 911 | 911 |
| 1000pF | | 102 | 102 | 102 | 102 | 102 |
| 1100pF | | 112 | 112 | 112 | 112 | 112 |
| 1200pF | | 122 | 122 | 122 | 122 | 122 |
| 1300pF | | 132 | 132 | 132 | 132 | 132 |
| 1500pF | | 152 | 152 | 152 | 152 | 152 |
| 1600pF | | 162 | 162 | 162 | 162 | 162 |
| 1800pF | | 182 | 182 | 182 | 182 | 182 |
| 2000pF | | 202 | 202 | 202 | 202 | 202 |
| 2200pF | | 222 | 222 | 222 | 222 | 222 |
| 2400pF | | 242 | 242 | 242 | 242 | 242 |
| 2700pF | | 272 | 272 | 272 | 272 | 272 |
| 3000pF | | 302 | 302 | 302 | 302 | 302 |
| 3300pF | | 332 | 332 | 332 | 332 | 332 |
| 3600pF | | 362 | 362 | 362 | 362 | 362 |
| 3900pF | | 392 | 392 | 392 | 392 | 392 |
| 4300pF | | 432 | 432 | 432 | 432 | 432 |
| 4700pF | | 472 | 472 | 472 | 472 | 472 |
| 5100pF | | 512 | 512 | 512 | 512 | 512 |
| 5600pF | | 562 | 562 | 562 | 562 | 562 |
| 6200pF | | 622 | 622 | 622 | 622 | 622 |
| 6800pF | | 682 | 682 | 682 | 682 | 682 |
| 7500pF | | 752 | 752 | 752 | 752 | 752 |
| 8200pF | | 822 | 822 | 822 | 822 | 822 |
| 9100pF | | 912 | 912 | 912 | 912 | 912 |
| 0.01μF | | 103 | 103 | 103 | 103 | 103 |
| 0.012μF | | 123 | 123 | 123 | 123 | 123 |
| 0.015μF | | 153 | 153 | 153 | 153 | 153 |
| 0.018μF | | 183 | 183 | 183 | 183 | 183 |
| 0.022μF | | 223 | 223 | 223 | 223 | 223 |
| 0.027μF | 273 | 273 | 273 | 273 | 273 | |
| 0.033μF | 333 | 333 | 333 | 333 | 333 | |
| 0.039μF | 393 | 393 | 393 | 393 | 393 | |
| 0.047μF | 473 | 473 | 473 | 473 | 473 | |
| 0.056μF | 563 | 563 | 563 | | | |
| 0.068μF | 683 | 683 | 683 | | | |
| 0.082μF | 823 | 823 | 823 | | | |
| 0.100μF | 104 | 104 | 104 | | | |
| 0.120μF | 124 | 124 | | | | |
| 0.150μF | 154 | 154 | | | | |
| 0.180μF | 184 | | | | | |
| Rated Voltage (VDC) | | 25 | 50 | 100 | 200 | 250 |
| Voltage Code | | 3 | 5 | 1 | 2 | A |

These products are protected under one or more of the following United States Patents and their non-US counterparts: US Pat. No. 7172985; U.S. Pat. No. 7670981.

Table 1C – C32X Style/Size, Capacitance Range Waterfall

| C321, C324, C325, C327 Style/Size (0.100" and 0.200" Lead Spacing) | | | | | |
|---|---|---|------------|------------|------------|
| Rated Voltage (VDC) | | 50 | 100 | 200 | 250 |
| Voltage Code | | 5 | 1 | 2 | A |
| Capacitance | Capacitance Tolerance | Capacitance Code (Available Capacitance) | | | |
| 1pF | D = ±0.5pF | 109 | 109 | 109 | 109 |
| 1.1pF | | 119 | 119 | 119 | 119 |
| 1.2pF | | 129 | 129 | 129 | 129 |
| 1.3pF | | 139 | 139 | 139 | 139 |
| 1.5pF | | 159 | 159 | 159 | 159 |
| 1.6pF | | 169 | 169 | 169 | 169 |
| 1.8pF | | 189 | 189 | 189 | 189 |
| 2.0pF | | 209 | 209 | 209 | 209 |
| 2.2pF | | 229 | 229 | 229 | 229 |
| 2.4pF | | 249 | 249 | 249 | 249 |
| 2.7pF | | 279 | 279 | 279 | 279 |
| 3.0pF | | 309 | 309 | 309 | 309 |
| 3.3pF | | 339 | 339 | 339 | 339 |
| 3.6pF | | 369 | 369 | 369 | 369 |
| 3.9pF | | 399 | 399 | 399 | 399 |
| 4.3pF | | 439 | 439 | 439 | 439 |
| 4.7pF | | 479 | 479 | 479 | 479 |
| 5.1pF | | 519 | 519 | 519 | 519 |
| 5.6pF | | 569 | 569 | 569 | 569 |
| 6.2pF | | 629 | 629 | 629 | 629 |
| 6.8pF | 689 | 689 | 689 | 689 | |
| 7.5pF | 759 | 759 | 759 | 759 | |
| 8.2pF | 829 | 829 | 829 | 829 | |
| 9.1pF | 919 | 919 | 919 | 919 | |
| 10pF | F = ±1% G = ±2% J = ±5% K = ±10% | 100 | 100 | 100 | 100 |
| 11pF | | 110 | 110 | 110 | 110 |
| 12pF | | 120 | 120 | 120 | 120 |
| 13pF | | 130 | 130 | 130 | 130 |
| 15pF | | 150 | 150 | 150 | 150 |
| 16pF | | 160 | 160 | 160 | 160 |
| 18pF | | 180 | 180 | 180 | 180 |
| 20pF | | 200 | 200 | 200 | 200 |
| 22pF | | 220 | 220 | 220 | 220 |
| 24pF | | 240 | 240 | 240 | 240 |
| 27pF | | 270 | 270 | 270 | 270 |
| 30pF | | 300 | 300 | 300 | 300 |
| 33pF | | 330 | 330 | 330 | 330 |
| 36pF | | 360 | 360 | 360 | 360 |
| 39pF | | 390 | 390 | 390 | 390 |
| 43pF | | 430 | 430 | 430 | 430 |
| 47pF | | 470 | 470 | 470 | 470 |
| 51pF | | 510 | 510 | 510 | 510 |
| 56pF | | 560 | 560 | 560 | 560 |
| 62pF | | 620 | 620 | 620 | 620 |
| 68pF | 680 | 680 | 680 | 680 | |
| 75pF | 750 | 750 | 750 | 750 | |
| 82pF | 820 | 820 | 820 | 820 | |
| 91pF | 910 | 910 | 910 | 910 | |
| 100pF | 101 | 101 | 101 | 101 | |
| 110pF | 111 | 111 | 111 | 111 | |
| 120pF | 121 | 121 | 121 | 121 | |
| 130pF | 131 | 131 | 131 | 131 | |
| 150pF | 151 | 151 | 151 | 151 | |
| 160pF | 161 | 161 | 161 | 161 | |
| 180pF | 181 | 181 | 181 | 181 | |
| 200pF | 201 | 201 | 201 | 201 | |
| Rated Voltage (VDC) | | 50 | 100 | 200 | 250 |
| Voltage Code | | 5 | 1 | 2 | A |

These products are protected under one or more of the following United States Patents and their non-US counterparts: US Pat. No. 7172985; U.S. Pat. No. 7670981.

Table 1C – C32X Style/Size, Capacitance Range Waterfall cont.

| C321, C324, C325, C327 Style/Size (0.100" and 0.200" Lead Spacing) | | | | | | |
|--|---|--|-----|-----|-----|--|
| Rated Voltage (VDC) | | 50 | 100 | 200 | 250 | |
| Voltage Code | | 5 | 1 | 2 | A | |
| Capacitance | Capacitance Tolerance | Capacitance Code (Available Capacitance) | | | | |
| 220pF | F = ±1% G = ±2% J = ±5% K = ±10% | 221 | 221 | 221 | 221 | |
| 240pF | | 241 | 241 | 241 | 241 | |
| 270pF | | 271 | 271 | 271 | 271 | |
| 300pF | | 301 | 301 | 301 | 301 | |
| 330pF | | 331 | 331 | 331 | 331 | |
| 360pF | | 361 | 361 | 361 | 361 | |
| 390pF | | 391 | 391 | 391 | 391 | |
| 430pF | | 431 | 431 | 431 | 431 | |
| 470pF | | 471 | 471 | 471 | 471 | |
| 510pF | | 511 | 511 | 511 | 511 | |
| 560pF | | 561 | 561 | 561 | 561 | |
| 620pF | | 621 | 621 | 621 | 621 | |
| 680pF | | 681 | 681 | 681 | 681 | |
| 750pF | | 751 | 751 | 751 | 751 | |
| 820pF | | 821 | 821 | 821 | 821 | |
| 910pF | | 911 | 911 | 911 | 911 | |
| 1000pF | | 102 | 102 | 102 | 102 | |
| 1100pF | | 112 | 112 | 112 | 112 | |
| 1200pF | | 122 | 122 | 122 | 122 | |
| 1300pF | | 132 | 132 | 132 | 132 | |
| 1500pF | | 152 | 152 | 152 | 152 | |
| 1600pF | | 162 | 162 | 162 | 162 | |
| 1800pF | | 182 | 182 | 182 | 182 | |
| 2000pF | | 202 | 202 | 202 | 202 | |
| 2200pF | | 222 | 222 | 222 | 222 | |
| 2400pF | | 242 | 242 | 242 | 242 | |
| 2700pF | | 272 | 272 | 272 | 272 | |
| 3000pF | | 302 | 302 | 302 | 302 | |
| 3300pF | | 332 | 332 | 332 | 332 | |
| 3600pF | | 362 | 362 | 362 | 362 | |
| 3900pF | | 392 | 392 | 392 | 392 | |
| 4300pF | | 432 | 432 | 432 | 432 | |
| 4700pF | | 472 | 472 | 472 | 472 | |
| 5100pF | | 512 | 512 | 512 | 512 | |
| 5600pF | | 562 | 562 | 562 | 562 | |
| 6200pF | | 622 | 622 | 622 | 622 | |
| 6800pF | | 682 | 682 | 682 | 682 | |
| 7500pF | | 752 | 752 | 752 | 752 | |
| 8200pF | | 822 | 822 | 822 | 822 | |
| 9100pF | | 912 | 912 | 912 | 912 | |
| 0.01μF | | 103 | 103 | 103 | 103 | |
| 0.012μF | | 123 | 123 | 123 | 123 | |
| 0.015μF | | 153 | 153 | 153 | 153 | |
| 0.018μF | | 183 | 183 | 183 | 183 | |
| 0.022μF | | 223 | 223 | 223 | 223 | |
| 0.027μF | | 273 | 273 | 273 | 273 | |
| 0.033μF | | 333 | 333 | 333 | 333 | |
| 0.039μF | | 393 | 393 | 393 | 393 | |
| 0.047μF | | 473 | 473 | 473 | 473 | |
| 0.056μF | | 563 | 563 | 563 | | |
| 0.068μF | | 683 | 683 | 683 | | |
| 0.082μF | | 823 | 823 | 823 | | |
| 0.100μF | | 104 | 104 | 104 | | |
| 0.120μF | | 124 | 124 | | | |
| 0.150μF | | 154 | 154 | | | |
| 0.180μF | | 184 | | | | |
| Rated Voltage (VDC) | | 50 | 100 | 200 | 250 | |
| Voltage Code | | 5 | 1 | 2 | A | |

These products are protected under one or more of the following United States Patents and their non-US counterparts: US Pat. No. 7172985; U.S. Pat. No. 7670981.

Table 1D – C33X Style/Size, Capacitance Range Waterfall

| C330, C331, C333, C335, C336 Style/Size (0.200" and 0.250" Lead Spacing) | | | | | |
|--|---|--|------|------|------|
| Rated Voltage (VDC) | | 50 | 100 | 200 | 250 |
| Voltage Code | | 5 | 1 | 2 | A |
| Capacitance | Capacitance Tolerance | Capacitance Code (Available Capacitance) | | | |
| 470pF | F = ±1% G = ±2% J = ±5% K = ±10% | 471* | 471* | 471* | 471* |
| 510pF | | 511* | 511* | 511* | 511* |
| 560pF | | 561* | 561* | 561* | 561* |
| 620pF | | 621* | 621* | 621* | 621* |
| 680pF | | 681* | 681* | 681* | 681* |
| 750pF | | 751* | 751* | 751* | 751* |
| 820pF | | 821* | 821* | 821* | 821* |
| 910pF | | 911* | 911* | 911* | 911* |
| 1000pF | | 102* | 102* | 102* | 102* |
| 1100pF | | 112* | 112* | 112* | 112* |
| 1200pF | | 122* | 122* | 122* | 122* |
| 1300pF | | 132* | 132* | 132* | 132* |
| 1500pF | | 152* | 152* | 152* | 152* |
| 1600pF | | 162* | 162* | 162* | 162* |
| 1800pF | | 182* | 182* | 182* | 182* |
| 2000pF | | 202* | 202* | 202* | 202* |
| 2200pF | | 222* | 222* | 222* | 222* |
| 2400pF | | 242* | 242* | 242* | 242* |
| 2700pF | | 272* | 272* | 272* | 272* |
| 3000pF | | 302* | 302* | 302* | 302* |
| 3300pF | | 332* | 332* | 332* | 332* |
| 3600pF | | 362* | 362* | 362* | 362* |
| 3900pF | | 392* | 392* | 392* | 392* |
| 4300pF | | 432* | 432* | 432* | 432* |
| 4700pF | | 472* | 472* | 472* | 472* |
| 5100pF | | 512* | 512* | 512* | 512* |
| 5600pF | | 562* | 562* | 562* | 562* |
| 6200pF | | 622* | 622* | 622* | 622* |
| 6800pF | | 682* | 682* | 682* | 682* |
| 7500pF | | 752* | 752* | 752* | 752* |
| 8200pF | | 822* | 822* | 822* | 822* |
| 9100pF | | 912* | 912* | 912* | 912* |
| 0.01µF | | 103* | 103* | 103* | 103* |
| 0.012µF | | 123* | 123* | 123* | 123* |
| 0.015µF | | 153* | 153* | 153* | 153* |
| 0.018µF | | 183* | 183* | 183* | 183* |
| 0.022µF | | 223* | 223* | 223* | 223* |
| 0.027µF | | 273* | 273* | 273* | 273* |
| 0.033µF | | 333* | 333* | 333* | 333* |
| 0.039µF | | 393* | 393* | 393* | 393* |
| 0.047µF | | 473* | 473* | 473* | 473* |
| 0.056µF | | 563* | 563* | 563 | 563 |
| 0.068µF | | 683* | 683* | 683 | 683 |
| 0.082µF | | 823* | 823* | 823 | 823 |
| 0.100µF | | 104* | 104* | 104 | 104 |
| 0.120µF | | 124* | 124 | 124 | |
| 0.150µF | | 154* | 154 | 154 | |
| 0.180µF | 184 | 184 | 184 | | |
| 0.220µF | 224 | 224 | | | |
| 0.270µF | 274 | 274 | | | |
| 0.330µF | 334 | 334 | | | |
| 0.390µF | 394 | | | | |
| 0.470µF | 474 | | | | |
| Rated Voltage (VDC) | | 50 | 100 | 200 | 250 |
| Voltage Code | | 5 | 1 | 2 | A |

These products are protected under one or more of the following United States Patents and their non-US counterparts: US Pat. No. 7172985; U.S. Pat. No. 7670981.

* Capacitor is supplied with a "Shoulder-Bend" lead configuration in Style/Size C330 and C331.

Table 1E – C34X Style/Size, Capacitance Range Waterfall

| C340, C346 Style/Size (0.200" Lead Spacing) | | | | |
|---|---|--|------|-----|
| Rated Voltage (VDC) | | 50 | 100 | 200 |
| Voltage Code | | 5 | 1 | 2 |
| Capacitance | Capacitance Tolerance | Capacitance Code (Available Capacitance) | | |
| 0.01µF | F = ±1% G = ±2% J = ±5% K = ±10% | 103* | 103* | 103 |
| 0.012µF | | 123* | 123 | 123 |
| 0.015µF | | 153 | 153 | 153 |
| 0.018µF | | 183 | 183 | 183 |
| 0.022µF | | 223 | 223 | 223 |
| 0.027µF | | 273 | 273 | 273 |
| 0.033µF | | 333 | 333 | 333 |
| 0.039µF | | 393 | 393 | 393 |
| 0.047µF | | 473 | 473 | 473 |
| 0.056µF | | 563 | 563 | 563 |
| 0.068µF | | 683 | 683 | 683 |
| Rated Voltage (VDC) | | 50 | 100 | 200 |
| Voltage Code | | 5 | 1 | 2 |

* Capacitor is supplied with a "Shoulder-Bend" lead configuration in Style/Size C340

Table 1F – C35X Style/Size, Capacitance Range Waterfall

| C350, C356 Style/Size (0.400" Lead Spacing) | | | | | |
|---|---|--|-----|-----|--|
| Rated Voltage (VDC) | | 50 | 100 | 200 | |
| Voltage Code | | 5 | 1 | 2 | |
| Capacitance | Capacitance Tolerance | Capacitance Code (Available Capacitance) | | | |
| 4700pF | F = ±1% G = ±2% J = ±5% K = ±10% | 472 | 472 | 472 | |
| 5100pF | | 512 | 512 | 512 | |
| 5600pF | | 562 | 562 | 562 | |
| 6200pF | | 622 | 622 | 622 | |
| 6800pF | | 682 | 682 | 682 | |
| 7500pF | | 752 | 752 | 752 | |
| 8200pF | | 822 | 822 | 822 | |
| 9100pF | | 912 | 912 | 912 | |
| 0.01µF | | 103 | 103 | 103 | |
| 0.012µF | | 123 | 123 | 123 | |
| 0.015µF | | 153 | 153 | 153 | |
| 0.018µF | | 183 | 183 | 183 | |
| 0.022µF | | 223 | 223 | 223 | |
| 0.027µF | | 273 | 273 | 273 | |
| 0.033µF | | 333 | 333 | 333 | |
| 0.039µF | | 393 | 393 | 393 | |
| 0.047µF | | 473 | 473 | 473 | |
| 0.056µF | | 563 | 563 | 563 | |
| 0.068µF | | 683 | 683 | 683 | |
| 0.082µF | | 823 | 823 | 823 | |
| 0.100µF | | 104 | 104 | 104 | |
| 0.120µF | | 124 | 124 | 124 | |
| 0.150µF | | 154 | 154 | 154 | |
| 0.180µF | | 184 | 184 | 184 | |
| 0.220µF | | 224 | 224 | 224 | |
| 0.270µF | | 274 | 274 | 274 | |
| 0.330µF | | 334 | 334 | 334 | |
| 0.390µF | | 394 | | | |
| 0.470µF | | 474 | | | |
| Rated Voltage (VDC) | | 50 | 100 | 200 | |
| Voltage Code | | 5 | 1 | 2 | |

These products are protected under one or more of the following United States Patents and their non-US counterparts: US Pat. No. 7172985; U.S. Pat. No. 7670981.

Soldering Process

Recommended Soldering Methods:

- Solder Wave
- Hand Soldering (Manual)

Recommended Soldering Profile:

- Optimum Wave Solder Profile



Mounting

All encased capacitors will pass the Resistance to Soldering Heat of MIL-STD-202, Method 210, Condition C. This test simulates wave solder topside board mount product. This demonstration of resistance to solder heat is in accordance with what is believed to be the industry standard. More severe treatment must be considered reflective of an improper soldering process.

The above figure is a recommended solder wave profile for both axial and radial leaded ceramic capacitors.

- Hand Soldering (Manual)

with Pre-heating

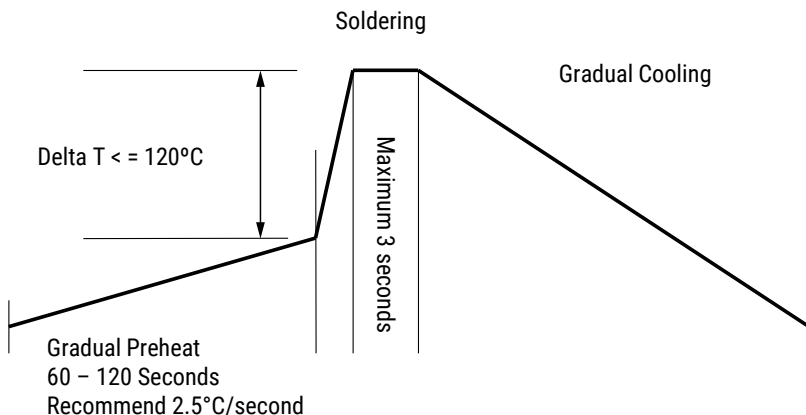

Table 2 – Performance & Reliability: Test Methods and Conditions

| Stress | Reference | Test or Inspection Method |
|------------------------------|--------------------------------|--|
| Solderability | J-STD-002 | Magnification 50X. Conditions: a) Method A, at 235°C, Category 3 |
| Temperature Cycling | JESD22 Method JA-104 | 5 cycles (-55°C to +125°C), measurement at 24 hours ±4 hours after test conclusion. |
| Biased Humidity | MIL-STD-202 Method 103 | Load humidity, 1,000 hours 85°C/85%RH and rated voltage. Add 100 K ohm resistor. Measurement at 24 hours ±4 hours after test conclusion. |
| | | Low volt humidity, 1,000 hours 85°C/85%RH and 1.5 V. Add 100 K ohm resistor. Measurement at 24 hours ±4 hours after test conclusion. |
| Moisture Resistance | MIL-STD-202 Method 106 | t = 24 hours/cycle. Steps 7a and 7b not required. Unpowered. Measurement at 24 hours ±4 hours after test conclusion. |
| Thermal Shock | MIL-STD-202 Method 107 | -55°C to +125°C. Note: Number of cycles required – 300. Maximum transfer time – 20 seconds. Dwell time – 15 minutes. Air – Air. |
| High Temperature Life | MIL-STD-202 Method 108/EIA-198 | 1,000 hours at 125°C (85°C for Z5U) with 1 X rated voltage applied. |
| Storage Life | MIL-STD-202 Method 108 | 125°C, 0 VDC for 1,000 hours. |
| Vibration | MIL-STD-202 Method 204 | 5 g for 20 minutes, 12 cycles each of 3 orientations. Note: Use 8"X5" PCB .031" thick 7 secure points on one long side and 2 secure points at corners of opposite sides. Parts mounted within 2" from any secure point. Test from 10 – 2,000 Hz. |
| Resistance to Soldering Heat | MIL-STD-202 Method 210 | Condition B. No preheat of samples. Note: single wave solder – procedure 2. |
| Terminal Strength | MIL-STD-202 Method 211 | Conditions A (454g), Condition C (227g) |
| Mechanical Shock | MIL-STD-202 Method 213 | Figure 1 of Method 213, Condition C. |
| Resistance to Solvents | MIL-STD-202 Method 215 | Add aqueous wash chemical – OKEM Clean or equivalent. |

Storage & Handling

The un-mounted storage life of a leaded ceramic capacitor is dependent upon storage and atmospheric conditions as well as packaging materials. While the ceramic chips enveloped under the epoxy coating themselves are quite robust in most environments, solderability of the wire lead on the final epoxy-coated product will be degraded by exposure to high temperatures, high humidity, corrosive atmospheres, and long term storage. In addition, packaging materials will be degraded by high temperature and exposure to direct sunlight – reels may soften or warp, and tape peel force may increase.

KEMET recommends storing the un-mounted capacitors in their original packaging, in a location away from direct sunlight, and where the temperature and relative humidity do not exceed 40 degrees centigrade and 70% respectively. For optimum solderability, capacitor stock should be used promptly, preferably within 18 months of receipt. For applications requiring pre-tinning of components, storage life may be extended if solderability is verified. Before cleaning, bonding or molding these devices, it is important to verify that your process does not affect product quality and performance. KEMET recommends testing and evaluating the performance of a cleaned, bonded or molded product prior to implementing and/or qualifying any of these processes.

Construction

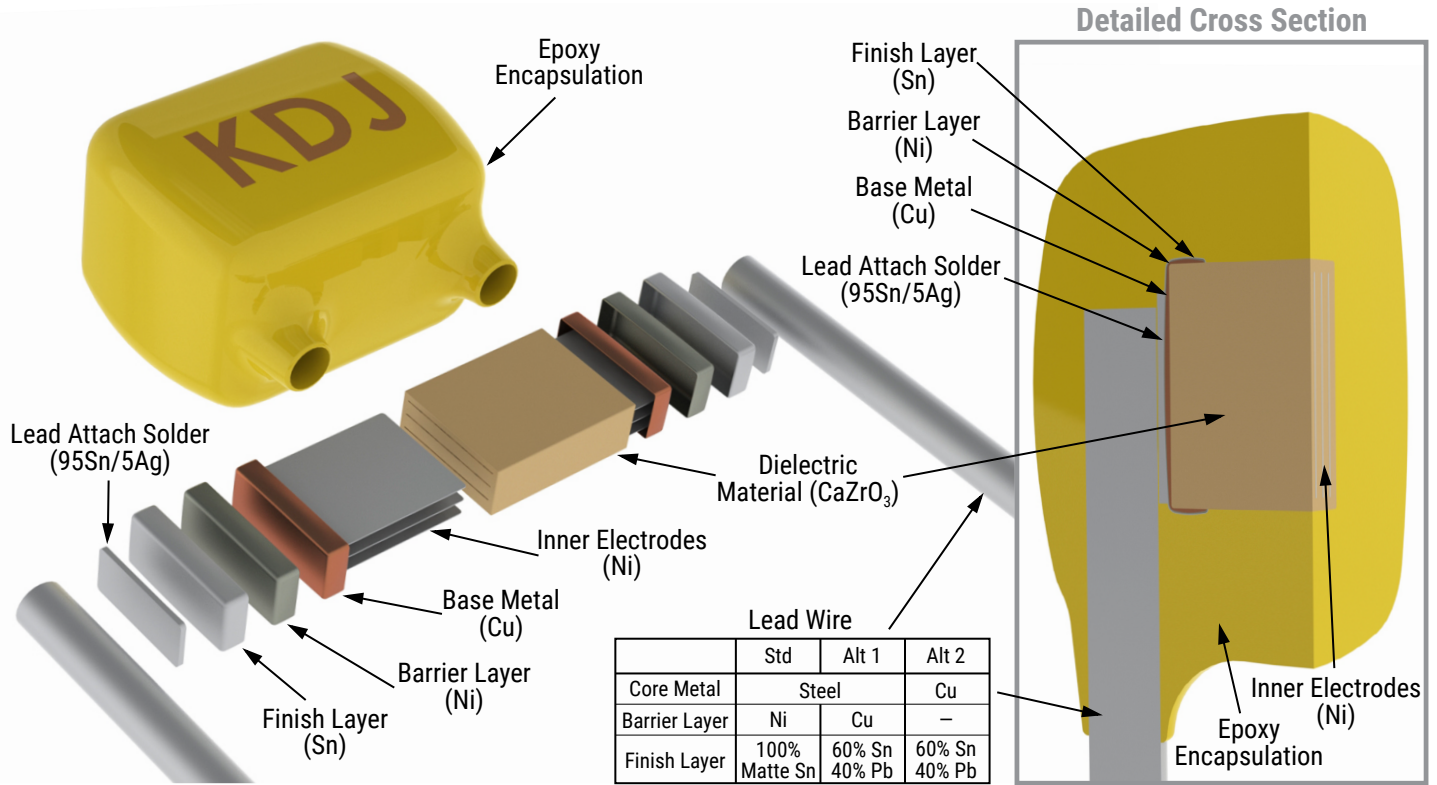

Marking

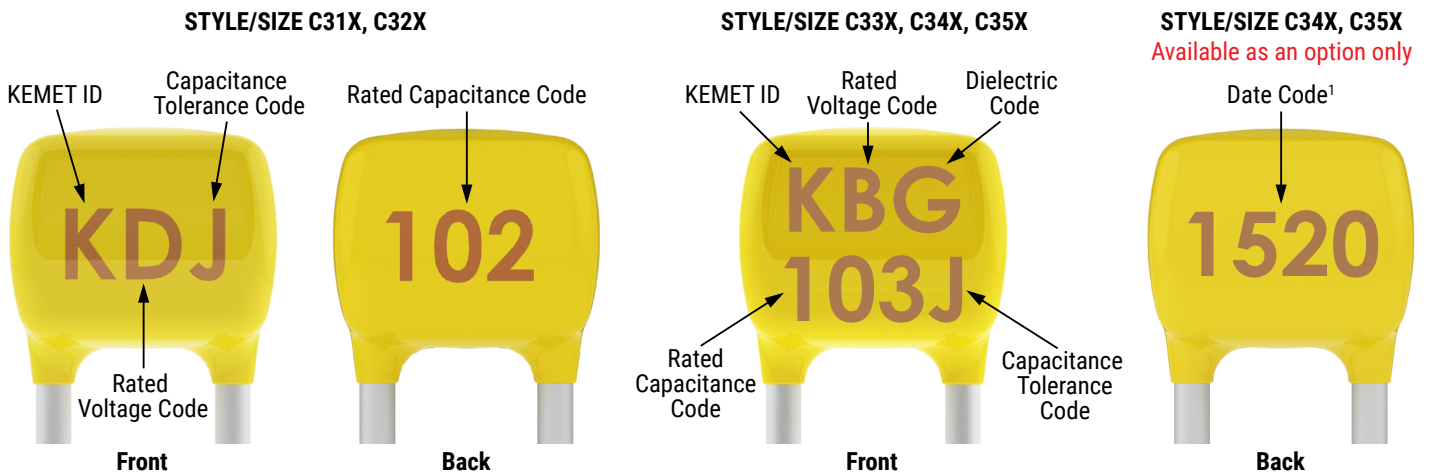

¹ To properly request the inclusion of the date code in the marking information provided on the component, ordering code C-SPEC 9207 must be added to the end of the ordering code.

| Date Code | |
|----------------------------------|--|
| 15 | 20 |
| Manufacturing Year: 15 = 2015 | Manufacturing Week: 20 = Week 20 (of mfg. calendar year) |

Packaging Quantities

| Style/ Size | Standard Bulk Quantity | Ammo Pack Quantity Maximum | Reel Quantity Maximum (12" Reel) |
|----------------|---------------------------|----------------------------------|--|
| 315 | 500/Bag | 2500 | 2500 |
| 316 | | | |
| 317 | | | |
| 318 | | | |
| 320 | | | |
| 321 | | | |
| 322 | | 2500 | 2500 |
| 323 | | | |
| 324 | | | |
| 325 | | | |
| 326 | | | |
| 327 | | | |
| 328 | 250/Bag | 1500 | 1500 |
| 330 | | N/A | N/A |
| 331 | | 1500 | |
| 333 | | 1500 | |
| 335 | | 1500 | |
| 336 | | 1500 | |
| 340 | 100/Bag | 1000 | 1000 |
| 346 | 50/Bag | N/A | 500 |
| 350 | | | |
| 356 | | | |

Tape & Reel Packaging Information

KEMET offers standard reeling of Molded and Conformally Coated Radial Leaded Capacitors in accordance with EIA standard 468. Parts are taped to a tagboard carrier strip, and wound on a reel as shown in Figure 1. Kraft paper interleaving is inserted between the layers of capacitors on the reel. Ammopack is also available, with the same lead tape configuration and package quantities.

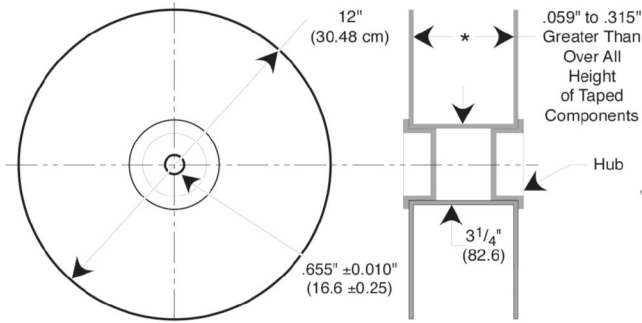

Figure 3: Standard Reel

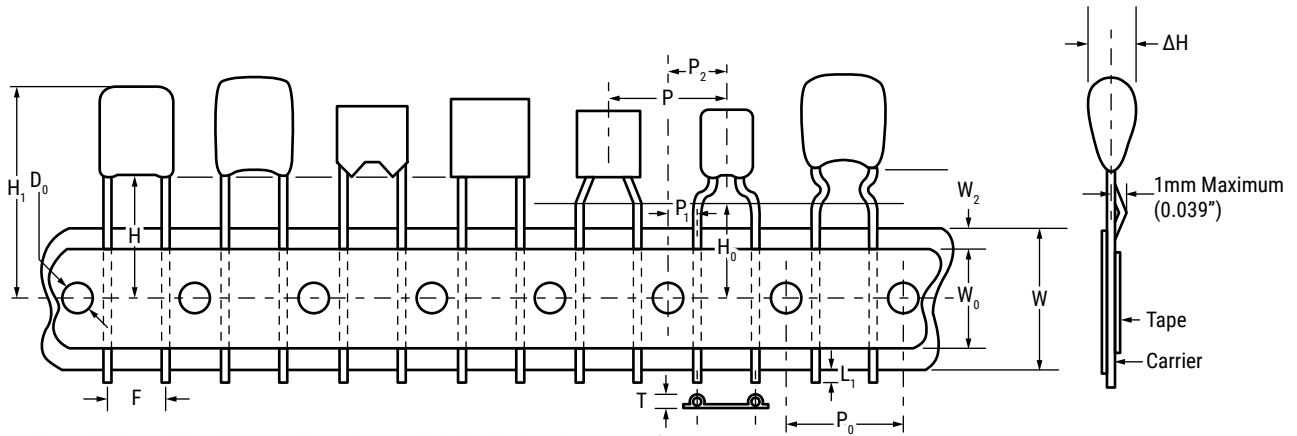
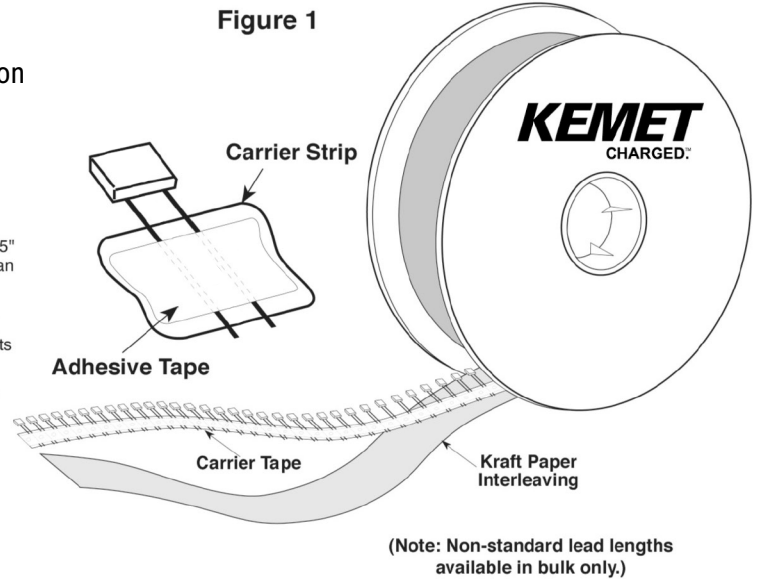

Figure 2: Lead Tape Configuration (See Table Below)

Ceramic Radial Tape and Reel Dimensions

Metric will govern

| Constant Dimensions – Millimeters (Inches) | | | | | | | | |
|--|-----------------------|----------------------------|------------------|---------------------|----------------|-------------------------------------|------------------|------------------|
| D_0 ±0.2 (0.008) | P_0 ±0.3 (0.012) | ΔH ±0.2 (0.008) | L_1 Maximum | t ±0.2 (0.008) | T Maximum | W +1.0/-0.5 (+0.039/-0.020) | W_0 Minimum | W_2 Maximum |
| 4.00 (0.157) | 12.7 (0.500) | 4.0 (0.157) | 1.0 (0.039) | 0.7 (0.051) | 1.5 (0.059) | 18.0 (0.709) | 5.0 (0.197) | 3.0 (0.118) |

Ceramic Radial Tape and Reel Dimensions cont.

Metric will govern

| Variable Dimensions – Millimeters (Inches) | | | | | | | |
|--|--|-------------------|--------------------------------|-------------------------------|-------------------------|--|-------------------------|
| F ±0.78 (0.030) ¹ | P ₁ ±0.30 (0.012) ¹ | P ±0.3 (0.012) | P ₂ ±1.3 (0.051) | H | | H ₀ | |
| | | | | Straight Lead Configuration | | Formed Lead Configuration ² | |
| | | | | Packaging C-Spec ³ | | | |
| | | | | 7301/7305 | 7303/7317 | 7301/7305 | 7303/7317 |
| 2.54 (0.100) | 5.08 (0.200) | 12.7 (0.500) | 6.35 (0.250) | 16.0±0.5 (0.630±0.020) | 18.0 (0.709) Minimum | 16.0±0.5 (0.630±0.020) | 18.0 (0.709) Minimum |
| 4.32 (0.170) | 3.89 (0.153) | 12.7 (0.500) | 6.35 (0.250) | | | | |
| 5.08 (0.200) | 3.81 (0.150) | 12.7 (0.500) | 6.35 (0.250) | | | | |
| 5.59 (0.220) | 3.25 (0.128) | 12.7 (0.500) | 6.35 (0.250) | | | | |
| 6.98 (0.275) | 2.54 (0.100) | 12.7 (0.500) | 6.35 (0.250) | | | | |
| 7.62 (0.300) | 2.24 (0.088) | 12.7 (0.500) | 6.35 (0.250) | | | | |
| 9.52 (0.375) | 7.62 (0.300) | 12.7 (0.500) | 6.35 (0.250) | | | | |
| 10.16 (0.400) | 7.34 (0.290) | 25.4 (1.000) | N/A | | | | |
| 12.06 (0.475) | 6.35 (0.250) | 25.4 (1.000) | N/A | | | | |
| 14.60 (0.575) | 5.08 (0.200) | 25.4 (1.000) | N/A | | | | |
| 17.14 (0.675) | 3.81 (0.15) | 25.4 (1.000) | N/A | | | | |

¹ Measured at the egress from the carrier tape, on the component side.

² Formed lead configuration includes: "shoulder bend", "inside kink", "outside kink", and "snap-in". For more information regarding available lead configurations see "Dimensions" section of this document.

³ The "Packaging C-Spec" is a 4 digit code which identifies the packaging type, lead length and/or lead material. When ordering, the proper code must be included in the 15th through 18th character positions of the ordering code. See "Ordering Information" section of this document for further details.

| Symbol Reference Table | |
|------------------------|---|
| D ₀ | Sprocket Hole Diameter |
| P ₀ | Sprocket Hole Pitch |
| P | Component Pitch |
| F | Lead Spacing |
| P ₁ | Sprocket Hole Center to Lead Center |
| P ₂ | Sprocket Hole Center To Component Center |
| H | Height to Seating Plane (Straight Leads Only) |
| H ₀ | Height to Seating Plane (Formed Leads Only) |
| H ₁ | Component Height Above Tape Center |
| ΔH | Component Alignment |
| L ₁ | Lead Protrusion |
| t | Composite Tape Thickness |
| W | Carrier Tape Width |
| W ₀ | Hold-Down Tape Width |
| W ₂ | Hold-Down Tape Location |

KEMET Electronics Corporation Sales Offices

For a complete list of our global sales offices, please visit www.kemet.com/sales.

Disclaimer

YAGEO Corporation and its affiliates do not recommend the use of commercial or automotive grade products for high reliability applications or manned space flight.

All product specifications, statements, information and data (collectively, the "Information") in this datasheet are subject to change. The customer is responsible for checking and verifying the extent to which the Information contained in this publication is applicable to an order at the time the order is placed. All Information given herein is believed to be accurate and reliable, but it is presented without guarantee, warranty, or responsibility of any kind, expressed or implied.

Statements of suitability for certain applications are based on KEMET Electronics Corporation's ("KEMET") knowledge of typical operating conditions for such applications, but are not intended to constitute – and KEMET specifically disclaims – any warranty concerning suitability for a specific customer application or use. The Information is intended for use only by customers who have the requisite experience and capability to determine the correct products for their application. Any technical advice inferred from this Information or otherwise provided by KEMET with reference to the use of KEMET's products is given gratis, and KEMET assumes no obligation or liability for the advice given or results obtained.

Although KEMET designs and manufactures its products to the most stringent quality and safety standards, given the current state of the art, isolated component failures may still occur. Accordingly, customer applications which require a high degree of reliability or safety should employ suitable designs or other safeguards (such as installation of protective circuitry or redundancies) in order to ensure that the failure of an electrical component does not result in a risk of personal injury or property damage.

Although all product-related warnings, cautions and notes must be observed, the customer should not assume that all safety measures are indicated or that other measures may not be required.

KEMET is a registered trademark of KEMET Electronics Corporation.

Looking for pricing, stock, or lifecycle information?

Click below to explore more details on WIN SOURCE:

 [View C317C102J1G5TA7301 on WIN SOURCE](#)

 [Kemet Information](#)

Optimize Your Supply Chain with WIN SOURCE Solutions

-  Global Sourcing Solution
-  Obsolete Management
-  Cost Control Management
-  Shortage Management
-  Alternative Solution
-  Excess Inventory Management