



**THE DATASHEET OF
MAX14714EWL+T**



MAX14714

Compact 6A Smart Power Path Selector

General Description

The MAX14714 compact 6A smart power path selector features a low, 11mΩ (typ) R_{ON} internal FET and provides the system power from two separate power sources. The device has two switches in SPDT configuration, with bidirectional current-blocking capability when the switch is off.

The MAX14714 features two individual enable inputs to control each power path. Each enable input controls the corresponding path as an independent switch. However, when both paths are enabled, the internal comparator controls the path based on the voltage at input nodes. The device also features an ultra-low supply current in the operating or off states for longer battery-life.

The device is available in a 15-bump (1.2mm x 2.0mm) wafer-level package (WLP) and operates over the -40°C to +85°C extended temperature range.

Applications

- Smartphones
- Tablet PCs
- e-Readers
- Wearables

Typical Application Circuit

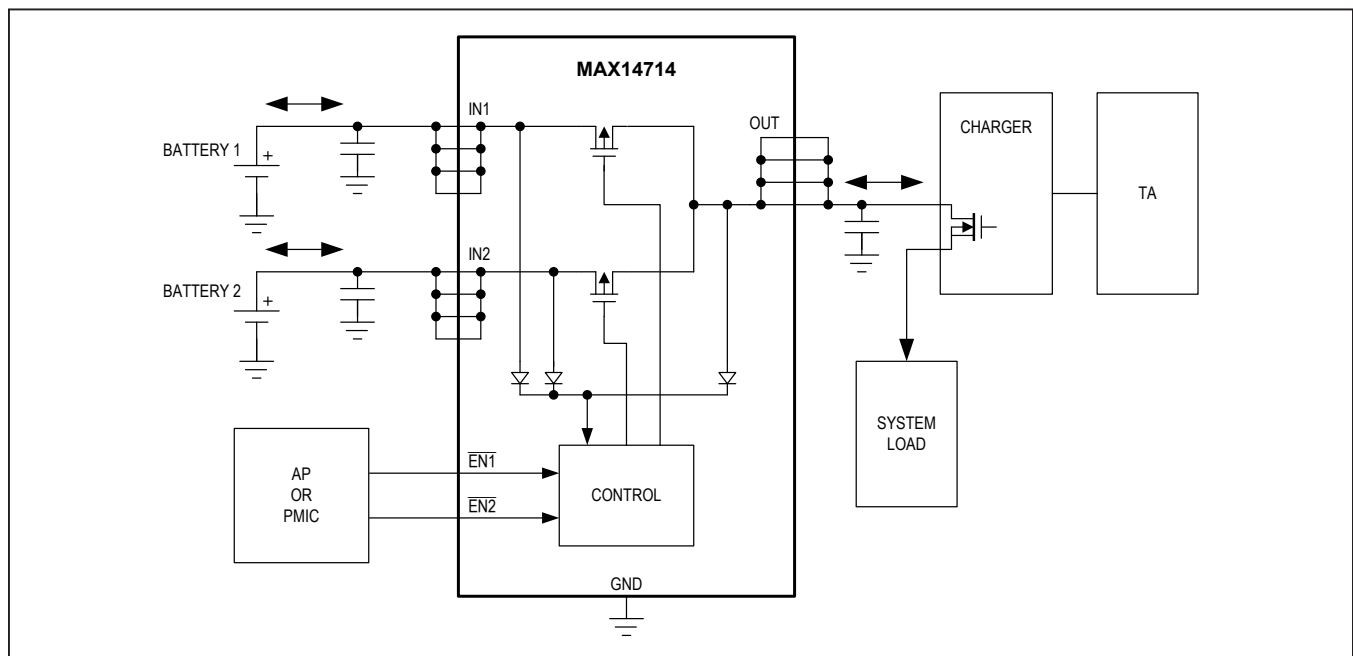

Features and Benefits

- Provides Robust Bidirectional Power Path
 - Wide Operating Input Voltage: +1.6V to +5.5V
 - 6A Continuous Current Capability
 - Integrated Two 11mΩ (typ) MOSFET Switches
- Enables Simple Power Switch Design
 - Individual Path Control
 - Automatic Power Path Control
 - Automatic Soft-Start
 - Powered by IN1, IN2, or OUT
- Significantly Extends Battery Life
 - Ultra-Low Quiescent Supply Current 2.5μA (typ)
 - Fast Switchover
 - Optimum Soft-Start Feature
- Compact Package Saves Board Space
 - 15-Bump 1.2mm x 2.0mm WLP

Ordering Information appears at end of data sheet.

Absolute Maximum Ratings

All voltages referenced to GND

IN1, IN2	-0.3V to +6V
OUT	-0.3V to +6V
EN1, EN2	-0.3V to +6V
Current into IN1, IN2	
DC Operating (Note 1)	6A
Pulse Rating (10ms)	9A

Continuous Power Dissipation ($T_A = +70^\circ\text{C}$)

WLP (derate 16.4mW/°C above +70°C).....	1312mW
Operating Temperature Range	-40°C to +85°C
Junction Temperature	+150°C
Storage Temperature Range	-65°C to +150°C
Soldering Temperature (reflow)	+260°C

Note 1: DC current is limited by thermal design of the system.

Package Thermal Characteristics (Note 2)

WLP

Junction-to-Ambient Thermal Resistance (θ_{JA})	52°C/W
--	--------

Note 2: Package thermal resistances were obtained using the method described in JEDEC specification JESD51-7, using a four-layer board. For detailed information on package thermal considerations, refer to www.maximintegrated.com/thermal-tutorial.

Stresses beyond those listed under "Absolute Maximum Ratings" may cause permanent damage to the device. These are stress ratings only, and functional operation of the device at these or any other conditions beyond those indicated in the operational sections of the specifications is not implied. Exposure to absolute maximum rating conditions for extended periods may affect device reliability.

Electrical Characteristics

($V_{IN1}, V_{IN2} = 1.6\text{V to } 5.5\text{V}; T_A = -40^\circ\text{C to } +85^\circ\text{C}$, unless otherwise noted. Typical values are at $V_{IN1}, V_{IN2} = 4.3\text{V}; T_A = +25^\circ\text{C}$.) (Note 3)

PARAMETER	SYMBOL	CONDITIONS	MIN	TYP	MAX	UNITS
SUPPLY OPERATION						
Operating Voltage	V_{IN1} V_{IN2}		1.6		5.5	V
Shutdown Current	I_{SHDN}	$\overline{EN1} = \text{high and } \overline{EN2} = \text{high}$			5.75	μA
Quiescent Current	I_{IN1} I_{IN2}	$\overline{EN1}$ or $\overline{EN2} = \text{low}, I_{LOAD} = 0\text{mA}$		2.5	7.5	μA
INTERNAL FET						
R_{ON} (IN1 or IN2 to OUT)	R_{ON}	$V_{IN_} = 4.3\text{V}, I_{OUT} = 1\text{A}, T_A = +25^\circ\text{C}$		11	15	m Ω
Soft-Start Trigger Voltage	$ V_{IN} - V_{OUT} $			0.95		V
Soft-Start Time	t_{SS}		1	5	10	ms
Soft-Start Output dV/dt Limit	I_{LIM_SS}	$C_{LOAD} = 100\mu\text{F}$		60		mV/ μs
IN1 - IN2 Comparator Rising Threshold	V_{THR_IN}	$V_{IN1} = 4.3\text{V}, V_{IN2} = 4.0\text{V}$, OUT is initially connected to IN1, V_{IN2} rises until OUT connects to IN2		500		mV
IN1 - IN2 Comparator Falling Threshold	V_{VTHF_IN}	$V_{IN1} = 4.3\text{V}, V_{IN2} = 4.6\text{V}$, OUT is initially connected to IN2, V_{IN2} falls until OUT connects to IN1		-500		mV
LOGIC INPUT ($\overline{EN1}, \overline{EN2}$)						
$\overline{EN1}, \overline{EN2}$ Input Logic High	V_{IH}		1.4			V
$\overline{EN1}, \overline{EN2}$ Input Logic Low	V_{IL}				0.4	V
$\overline{EN1}, \overline{EN2}$ Input Leakage Current	I_{LEAK}	$V_{\overline{EN}_} = 0\text{V}, 5.5\text{V}$	-1		1	μA

Electrical Characteristics (continued)

($V_{IN1}, V_{IN2} = 1.6V$ to $5.5V$; $T_A = -40^{\circ}C$ to $+85^{\circ}C$, unless otherwise noted. Typical values are at $V_{IN1}, V_{IN2} = 4.3V$; $T_A = +25^{\circ}C$.) (Note 3)

PARAMETER	SYMBOL	CONDITIONS	MIN	TYP	MAX	UNITS
DYNAMIC PERFORMANCE (NOTE 4)						
Single-Path Turn-On Time	t_{ON}	Time from \overline{EN}_- low to OUT reaches 90% of IN_- voltage, no load. (Figure 2)		6.5		μs
Single-Path Turn-Off Time	t_{OFF}	$V_{IN_-} = 3V, V_{\overline{EN}_-} = 0V$ to $3V, R_{LOAD} = 1k\Omega$. Time from \overline{EN}_- high to OUT reaches 10% of its initial value. (Figure 2)		8		μs
Automatic Switchover Enable Time	t_{ASO}	$V_{IN1} = 3.8V, V_{IN2} = 4.3V$ $V_{\overline{EN1}} = 0V, V_{\overline{EN2}} = 3V$ to $0V$ to OUT reaches 90% of $IN2$. (Figure 2)		2	5	μs
Automatic Switchover Break-Before-Make	t_{BBM}	$V_{IN1} = 3.7V, V_{IN2} = 3V$ to $4.3V$ $V_{\overline{EN1}} = 0V, V_{\overline{EN2}} = 0V,$ OUT = 100mA and no load capacitor.	0	0.4	2	μs
Automatic Switchover Debounce Time	t_{ASDEB}	$V_{IN1} = 3.3V, V_{IN2} = 4.3V$ to $3V$ $V_{\overline{EN1}} = 0V, V_{\overline{EN2}} = 0V$. (Figure 3)		2		μs

Note 3: All devices are 100% production tested at $T_A = +25^{\circ}C$. Specifications over the operating temperature range are guaranteed by design.

Note 4: All timing is measured using 20% and 80% levels unless otherwise specified.

Timing Diagrams

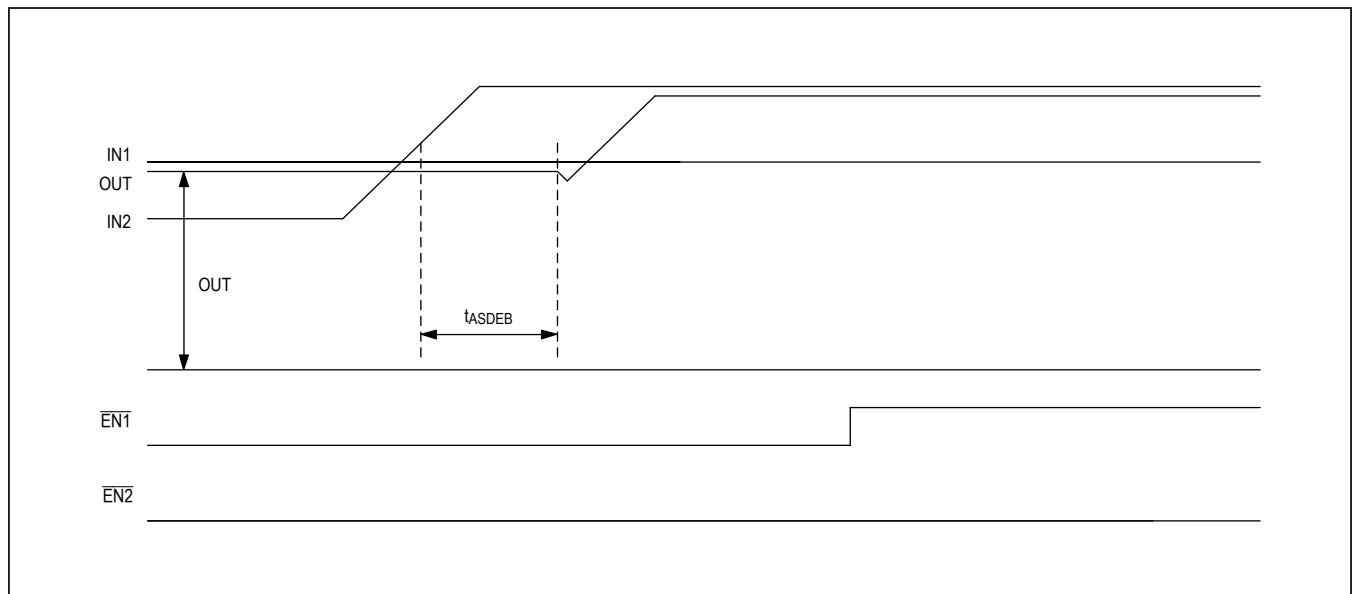

Figure 1. Automatic Switch Operation: IN2 Rise

Timing Diagrams (continued)

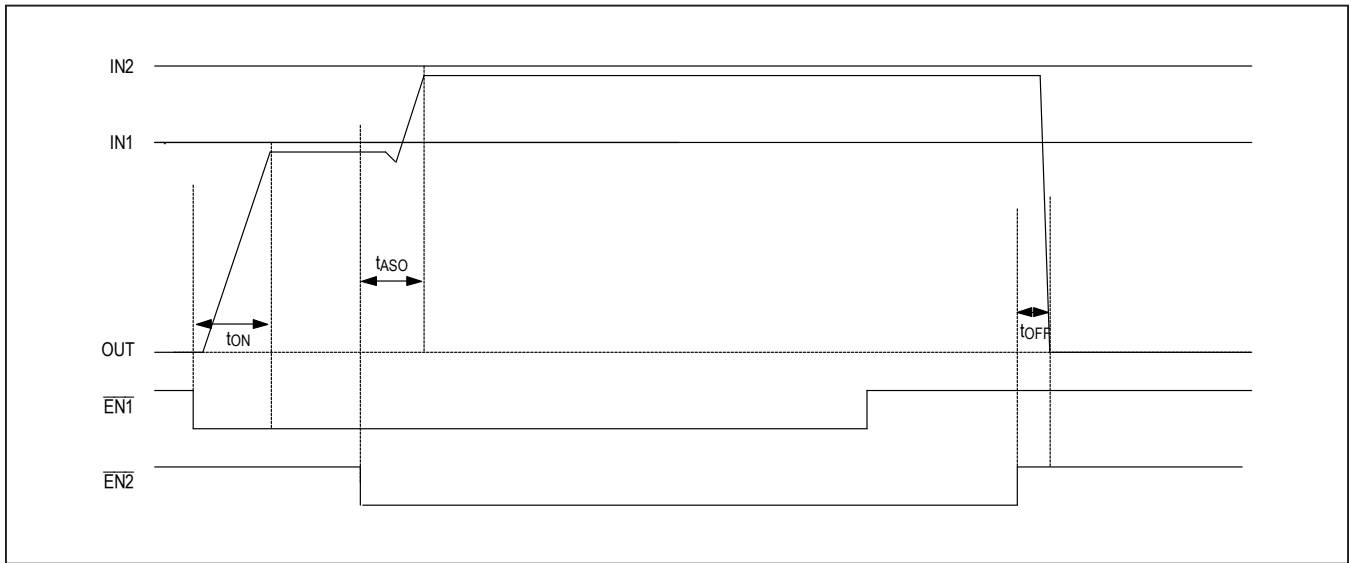

Figure 2. Automatic Switch Operation: $\overline{EN2}$ On (Time scale is exaggerated for easy recognition in the waveform)

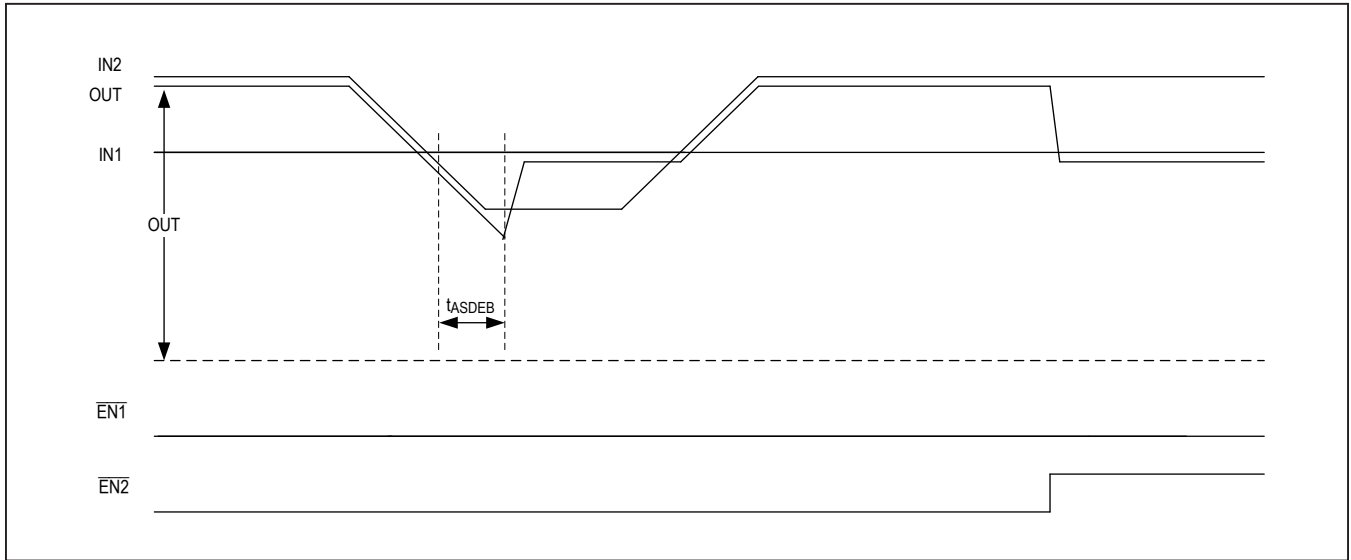
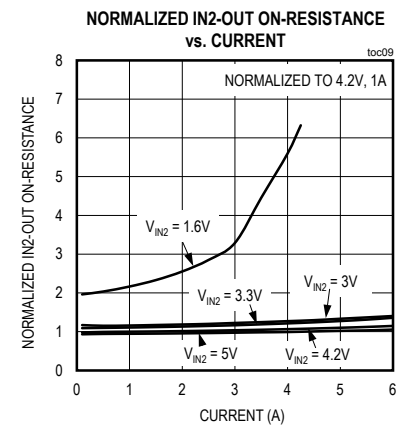
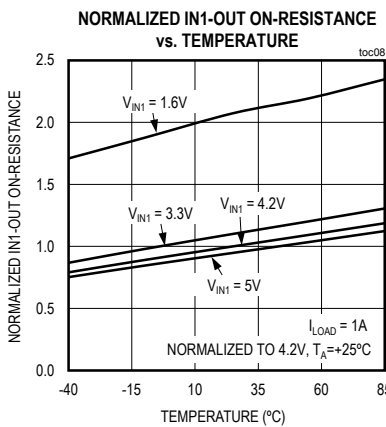
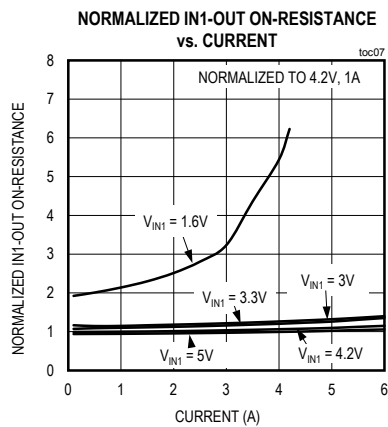
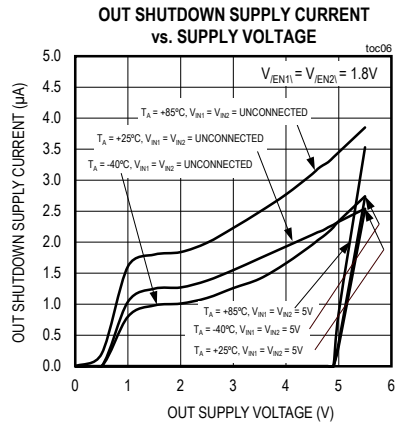
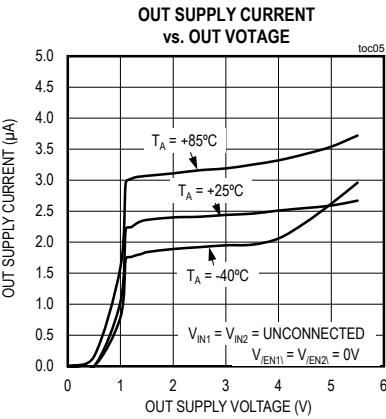
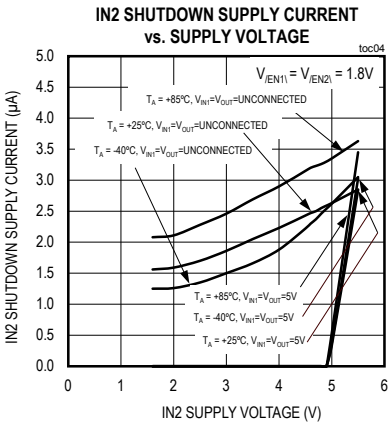
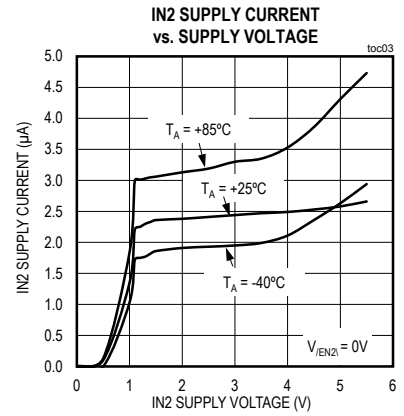
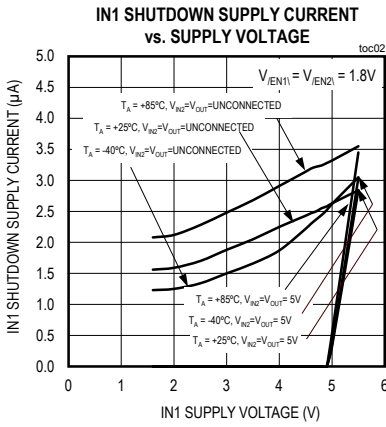
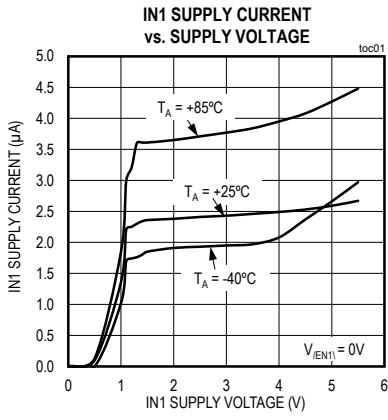

Figure 3. Automatic Switch Operation: IN2 Sag (Time scale is exaggerated for easy recognition in the waveform)

Typical Operating Characteristics

($C_{IN1,IN2} = 0.1\mu F$, $C_{OUT} = 100\mu F$, $T_A = +25^\circ C$, unless otherwise noted.)



Typical Operating Characteristics (continued)

($C_{IN1,IN2} = 0.1\mu F$, $C_{OUT} = 100\mu F$, $T_A = +25^\circ C$, unless otherwise noted.)

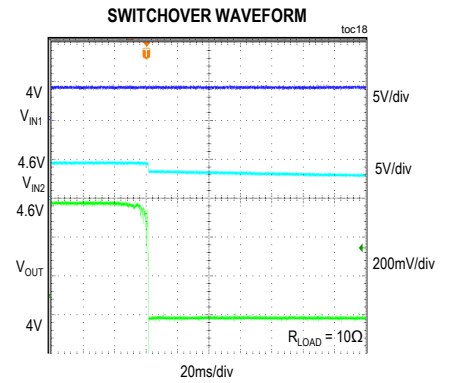
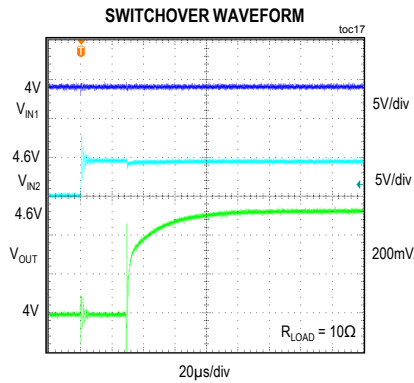
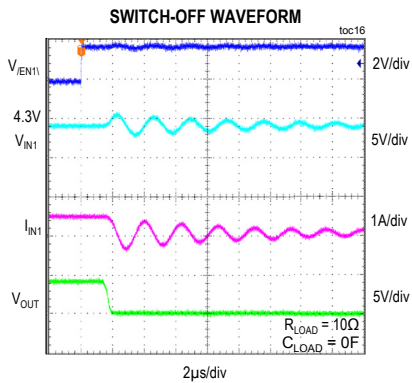
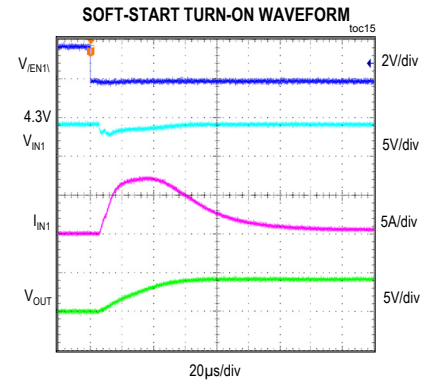
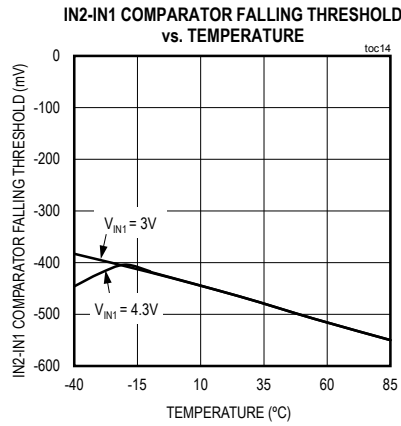
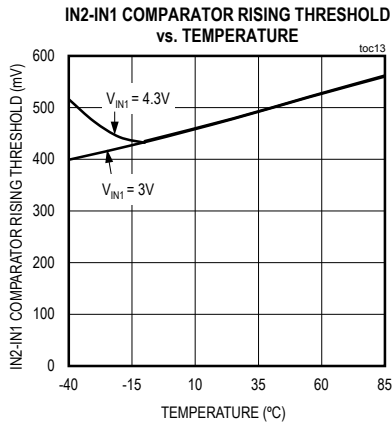
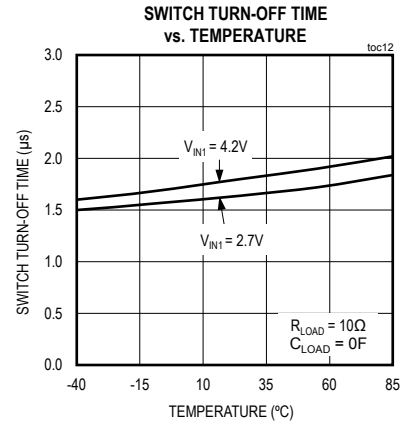
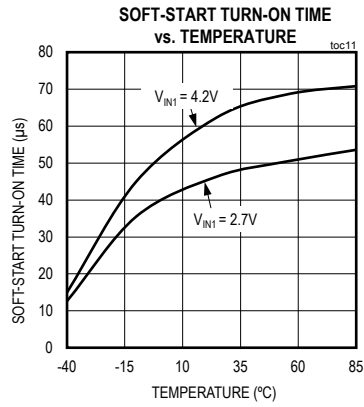
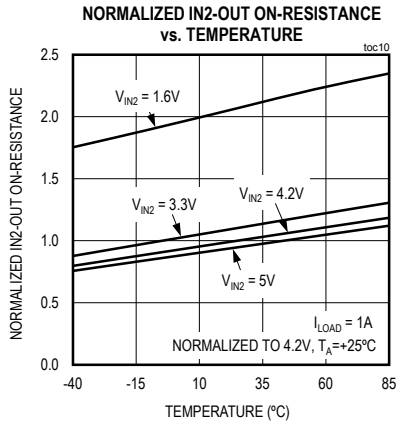

Typical Operating Characteristics (continued)

($C_{IN1,IN2} = 0.1\mu F$, $C_{OUT} = 100\mu F$, $T_A = +25^\circ C$, unless otherwise noted.)

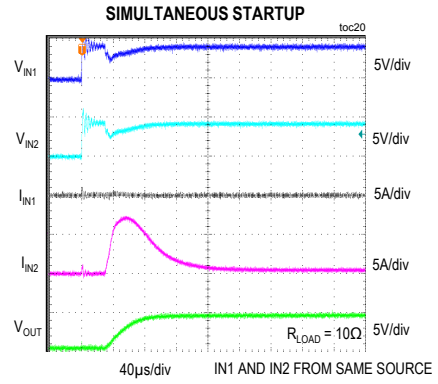
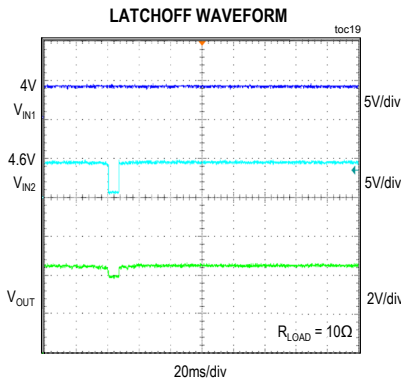

Bump Configuration

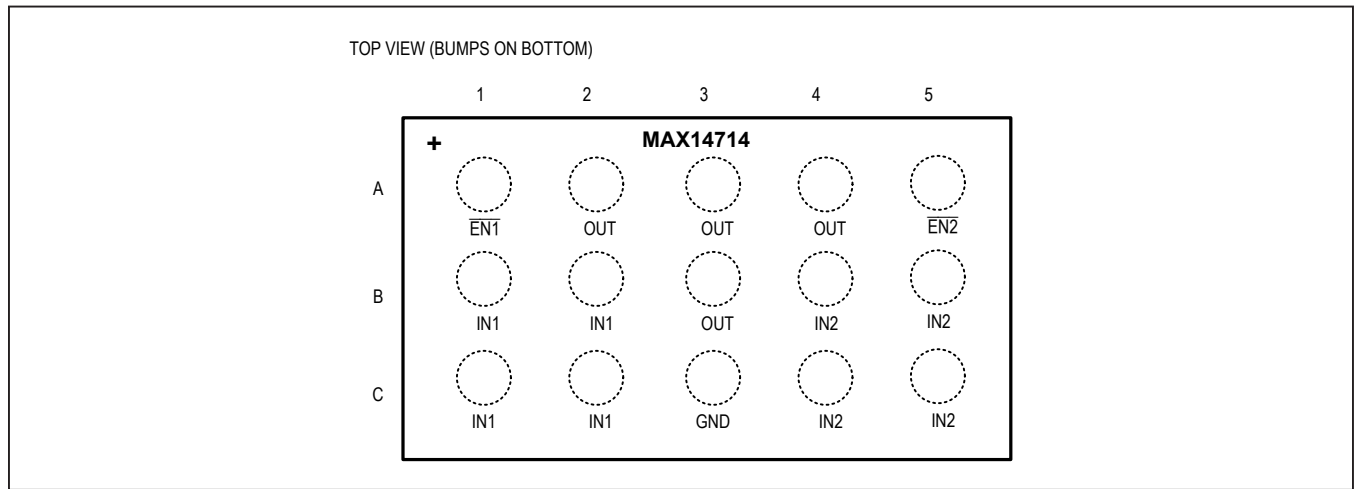

Bump Description

BUMP	NAME	FUNCTION
A1	$\overline{EN1}$	Active-Low Enable Input for IN1, Switch 1.
A2, A3, A4, B3	OUT	Common Switch Output.
A5	$\overline{EN2}$	Active-Low Enable Input for IN2, Switch 2.
B1, B2, C1, C2	IN1	Power Input 1.
B4, B5, C4, C5	IN2	Power Input 2.
C3	GND	Ground.

Detailed Description

The MAX14714 compact 6A smart power path selector device features a low, 11m Ω (typ) R_{ON} internal FET and provides the system power from two separate power sources. The device has two switches in SPDT configuration, with a bidirectional current-blocking capability when the switch is turned off.

The MAX14714 features two individual enable inputs to control each power path. Each enable input controls the corresponding path as an independent switch. However, when both paths are enabled, the internal comparator controls the path based on voltage at input nodes to auto-select the higher voltage input.

Enable Inputs

$\overline{EN1}$ and $\overline{EN2}$ active-low enable inputs control the two switches position. (Table 1)

Soft-Start

When a switch is enabled, and if the voltage difference between IN_{-} and OUT is greater than 0.95V (typ), the device performs soft-start for 5ms (typ) to prevent high inrush current. During soft-start, the output dV/dt is limited to 60mV/ μ s (typ). The soft-start feature is bidirectional for either IN_{-} or OUT supply.

Auto-Selection

When both $\overline{EN1}$ and $\overline{EN2}$ are low, the device is in auto-selection mode and the switch with higher voltage on input is turned on. A difference of V_{THR_IN} (500mV, typ)

Table 1. Enable Control

$\overline{EN1}$	$\overline{EN2}$	SWITCH STATUS
0	0	Auto Selection: switch 1 or switch 2 on*
1	0	Switch 2 on, switch 1 off
0	1	Switch 1 on, switch 2 off
1	1	Switch 1 and switch 2 both off

**When voltages on $IN1$ and $IN2$ are about the same, the device selects $IN2$ as the supply source. Please refer to Auto-Selection for details.*

between $IN1$ and $IN2$ is required in order to switch to the higher supply voltage.

Once the device selects the switch, the switch is on as long as the other input is not higher by V_{THR_IN} . If frequent jittering is expected from the power source, manual selection is recommended once the power source is stabilized. If auto-selection latching is preferred, please contact the factory for a latching option.

In case voltages on $IN1$ and $IN2$ are about the same, and $\overline{EN1}$ and $\overline{EN2}$ both go from high to low, the device selects $IN2$ as the supply source. After this initial choice, normal auto-selection resumes.

Bidirectional Current-Blocking

The bidirectional FET switch prevents current flowing from either side when the switch is off.

Ordering Information

PART	ENABLE POLARITY	TEMP RANGE	BUMP-PACKAGE
MAX14714EWL+	ACTIVE-LOW	-40°C to +85°C	15 WLP

+Denotes a lead(Pb)-free/RoHS-compliant package.

Chip Information

PROCESS: BiCMOS

Package Information

For the latest package outline information and land patterns (footprints), go to www.maximintegrated.com/packages. Note that a "+", "#", or "-" in the package code indicates RoHS status only. Package drawings may show a different suffix character, but the drawing pertains to the package regardless of RoHS status.

PACKAGE TYPE	PACKAGE CODE	OUTLINE NO.	LAND PATTERN NO.
15 WLP	W151E2+1	21-1031	Refer to Application Note 1891

Revision History

REVISION NUMBER	REVISION DATE	DESCRIPTION	PAGES CHANGED
0	9/14	Initial release	—

For pricing, delivery, and ordering information, please contact Maxim Direct at 1-888-629-4642, or visit Maxim Integrated's website at www.maximintegrated.com.

Maxim Integrated cannot assume responsibility for use of any circuitry other than circuitry entirely embodied in a Maxim Integrated product. No circuit patent licenses are implied. Maxim Integrated reserves the right to change the circuitry and specifications without notice at any time. The parametric values (min and max limits) shown in the Electrical Characteristics table are guaranteed. Other parametric values quoted in this data sheet are provided for guidance.

Looking for pricing, stock, or lifecycle information?

Click below to explore more details on WIN SOURCE:

- ⊖ [View MAX14714EWL+T on WIN SOURCE](#)
- ⊖ [Maxim Integrated Information](#)

Optimize Your Supply Chain with WIN SOURCE Solutions

- ✓ Global Sourcing Solution
- ✓ Obsolete Management
- ✓ Cost Control Management
- ✓ Shortage Management
- ✓ Alternative Solution
- ✓ Excess Inventory Management