



**THE DATASHEET OF
KMT072NGJLHS**



KMT0 Series

Ultra Miniature Tactile Switch for SMT 3.4 x 2.6 mm,
with 0.65 mm Height Actuator



Specifications

Function	Momentary action, normally open
Contact Arrangement	1 make contact = SPST, N.O.
Terminals	J lead type for SMT
Sealing	IP68

Electrical Characteristics

Maximum Power	0.3 VA
Maximum Voltage	32 VDC
Minimum Voltage	20 mV
Maximum Current DC	25 mA
Minimum Current DC	1 mA ¹
Dielectric Strength	≥ 250 Vrms (1mn)
Contact Resistance	≤ 150mΩ
Insulation Resistance	≥ 50MΩ
Bounce Time	≤ 6 ms

Note:

1. For ULC version minimum current is 1uA at 1.8 VDC

Environmental Characteristics

Operating Temperature	-40°C to 85°C
Storage Temperature	-55°C to 85°C

Description

The KMT0 series nano-miniature SMT top actuated switch comes with the smallest footprint and thickness and an integrated actuator. Its extended life cycle makes it ideal for the smallest of applications that must last a long time while withstanding the harshest of environments, including Bluetooth headsets, MP3 accessories and hearing aids.

Features & Benefits

- 3.4 x 2.6 mm footprint
- Smallest thickness with integrater actuator
- Extended life cycles
- IP68
- Ultra low current capabilities

Applications

- Mobile Phones
- Hearing Aids
- MP3 accessories
- Bluetooth Headset
- Automotive keyless entry system
- Smoke and CO detectors
- E-readers
- Home automation remote controls

Dimensions (mm)

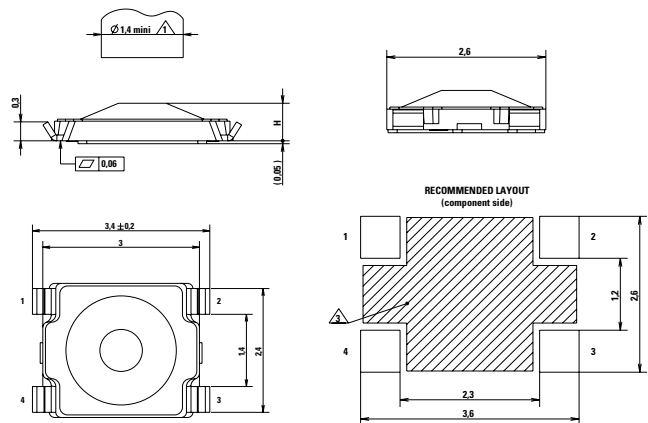

Designation	H ±0.07
KMT01x	0.63
KMT02x	0.63
KMT03x	0.65
KMT07x	0.65

KMT0 Series

Ultra Miniature Tactile Switch for SMT 3.4 x 2.6 mm,
with 0.65 mm Height Actuator



Soldering Profile

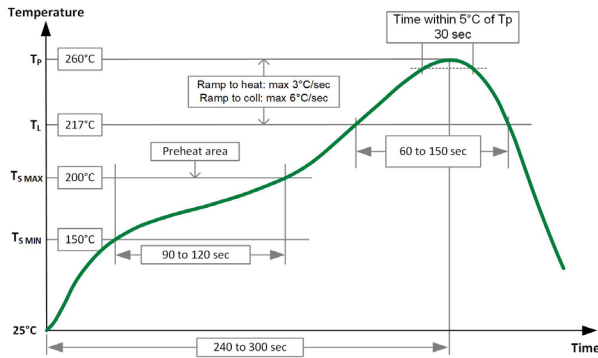

T_p	Peak package body Temperature
T_l	Liquidous Temperature
T_s	Preheat/Soak Temperature

Note: Up to 2 reflow cycles in accordance with the above temperature profile

Soldering process: Depending on the application, this component is suited to the following methods:

- Terminals being silver or gold plated over a nickel barrier, the use of slightly activated flux is suitable.
- Lead free soldering process in accordance with the definition on the left.

Tape & Reel

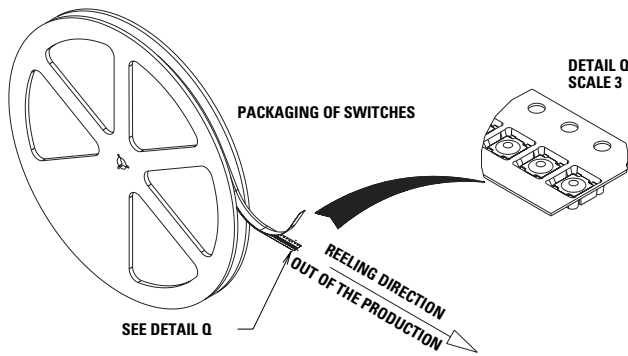

Packaging Details

Type	Tape & reel
Number of Parts in Packaging	5,000
Other Information	Tape and reel per EIA 481 Dry pack with desiccant
External diameter	180 mm
Transport Conditions	According to specification NF H00-060
MSL	3

Tape & Reel

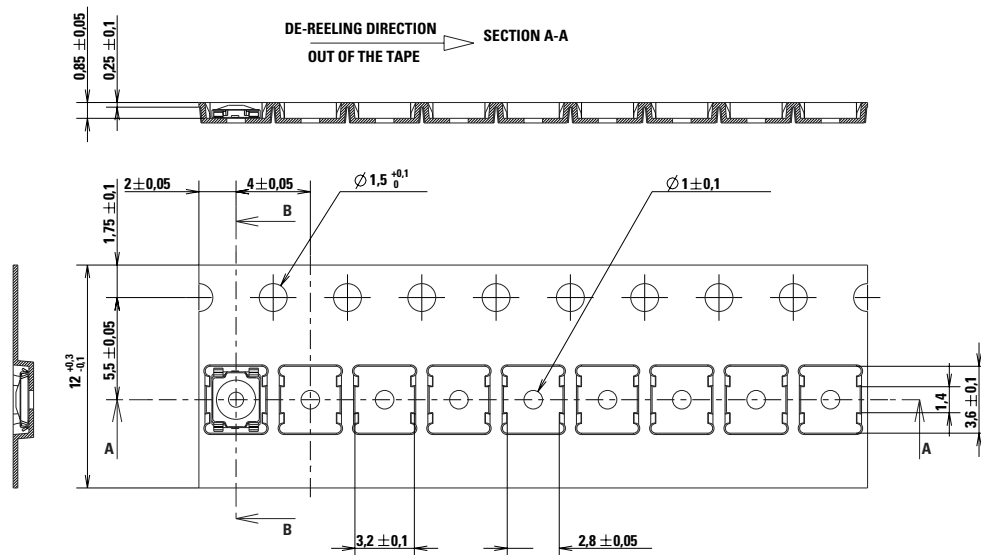

KMT0 Series

Ultra Miniature Tactile Switch for SMT 3.4 x 2.6 mm, with 0.65 mm Height Actuator



Ordering Number

Our easy build-a-switch concept allows you to mix and match options to create the switch you need. To order, select desired option from each category and place it in the appropriate box. However, please note that all the combinations of these options are not feasible. For any part number different from those listed above, please consult your local representative.

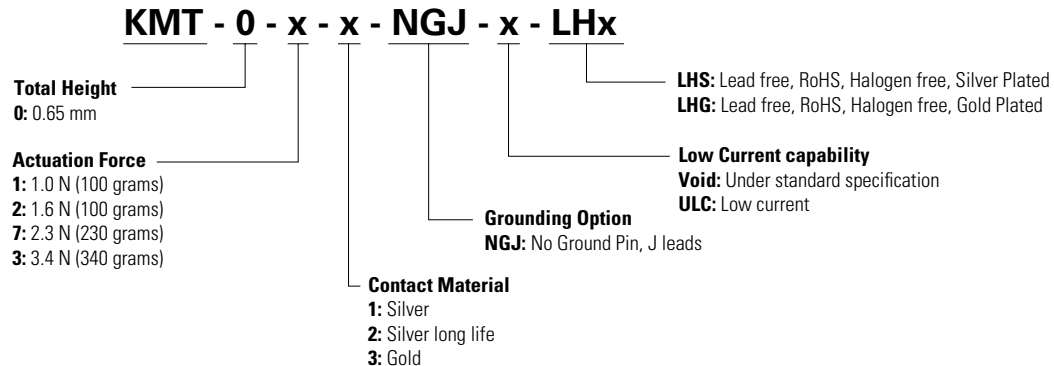

Note: Minimum actuator diameter is 1.4 mm. It is recommended to enlarge this diameter to a full flat surface covering the switch.

Mechanical Characteristics

Supply Status	LITTELFUSE Orderable Part Number	Description	Contact & Terminals Plating	Operating Force Fa (Newtons)	Tactile ratio (min)	Operating Life (operations)	Electrical Travel (mm)
✓	Y34H01122FP	KMT011 NGJ LHS	Silver	1±0.25	10%	300,000	0.15±0.1
✓	Y34H01132FP	KMT011 NGJ ULC LHS	Silver	1±0.25	10%	300,000	0.15±0.1
✓	Y34H01222FP	KMT012 NGJ LHS	Silver	1±0.25	10%	1,000,000	0.15±0.1
✓	Y34H01322FP	KMT013 NGJ LHG	Gold	1±0.25	10%	300,000	0.15±0.1
✓	Y34H02122FP	KMT021 NGJ LHS	Silver	1.6±0.4	30%	300,000	0.15±0.1
✓	Y34H02222FP	KMT022 NGJ LHS	Silver	1.6±0.4	30%	600,000	0.15±0.1
✓	Y34H03122FP	KMT031 NGJ LHS	Silver	3.4±0.85	30%	300,000	0.15±0.1
✓	Y34H03132FP	KMT031 NGJ ULC LHS	Silver	3.4±0.85	30%	300,000	0.15±0.1
✓	Y34H03322FP	KMT033 NGJ LHG	Gold	3.4±0.85	30%	300,000	0.15±0.1
✓	Y34H07122FP	KMT071 NGJ LHS	Silver	2.3±0.575	30%	300,000	0.15±0.1
✓	Y34H07132FP	KMT071 NGJ LHS ULC	Silver	2.3±0.575	30%	300,000	0.15±0.1
✓	Y34H07222FP	KMT072 NGJ LHS	Silver	2.3±0.575	30%	600,000	0.15±0.1

Special Delta Version

Supply Status	LITTELFUSE Orderable Part Number	Description	Contact & Terminals Plating	Operating Force Fa (Newtons)	Tactile ratio (min)	Operating Life (operations)	Electrical Travel (mm)
✓	Y34H07152FP	KMT071 NGJ LHS ULC SPD	Silver	2.3±0.575	39%	300,000	0.15±0.1

Notes:

1. Supply status:

✓ : Available for ordering

ORO : Available On Request Only. Please contact your Littelfuse representative for details.

2. Specifications listed above are for switches with standard options. For information on specific and custom switches, consult Customer Service Center.



Liability Limitation

This datasheet does not provide enough information for applications that require a certain level of quality or safety such as automotive, medical systems, or safety equipment. Please contact customer service for the contractual specification package.

Disclaimer Notice - Information furnished is believed to be accurate and reliable. However, users should independently evaluate the suitability of and test each product selected for their own applications. Littelfuse products are not designed for, and may not be used in, all applications. Read complete Disclaimer Notice at <http://www.littelfuse.com/disclaimer-electronics>.

Looking for pricing, stock, or lifecycle information?

Click below to explore more details on WIN SOURCE:

-  [View KMT072NGJLHS on WIN SOURCE](#)
-  [C&K Components Information](#)

Optimize Your Supply Chain with WIN SOURCE Solutions

-  Global Sourcing Solution
-  Obsolete Management
-  Cost Control Management
-  Shortage Management
-  Alternative Solution
-  Excess Inventory Management