



**THE DATASHEET OF
ACML-0805-102-T**



Multilayer Ferrite Chip Bead



ACML-0805 Series

Request Samples



Check Inventory



2.0 x 1.25 x 0.85mm
RoHS/RoHS II Compliant
MSL Level = 1

Features

- Multilayer monolithic construction yields high reliability
- Nickel barrier terminations provide excellent solder heat resistance
- Suitable for flow and RoHS reflow soldering

Applications

- Video equipment, audio equipment
- Automotive electrical equipment
- Communication equipment
- OA equipment and other

Electrical Specifications

Part No.	Impedance Z(Ω) $\pm 25\%$	Test Frequency	DCR (Ω)	I _R (mA)
		(MHz)	Max	Max
ACML-0805-070	7*	100	0.04	2000
ACML-0805-110	11*	100	0.04	2200
ACML-0805-170	17	100	0.04	2000
ACML-0805-190	19	100	0.04	2000
ACML-0805-260	26	100	0.05	1500
ACML-0805-310	30	100	0.05	1500
ACML-0805-360	36	100	0.10	1000
ACML-0805-500	50	100	0.10	1000
ACML-0805-600	60	100	0.10	1000
ACML-0805-700	70	100	0.10	1000
ACML-0805-800	80	100	0.10	1000
ACML-0805-101	100	100	0.15	800
ACML-0805-121	120	100	0.15	800
ACML-0805-151	150	100	0.18	700
ACML-0805-181	180	100	0.18	700
ACML-0805-221	220	100	0.20	600
ACML-0805-301	300	100	0.20	500
ACML-0805-421	420	100	0.30	500
ACML-0805-501	500	100	0.30	500
ACML-0805-601	600	100	0.30	500
ACML-0805-751	750	100	0.35	500
ACML-0805-102	1000	100	0.35	500
ACML-0805-122	1200	50	0.50	200
ACML-0805-152	1500	100	0.40	500
ACML-0805-202	2000	100	0.50	500

*: Impedance tolerance: 0 ~ 15 Ω

Operating Temperature Range: -55°C ~ + 125°C

Storage Temperature Range: -10°C ~ + 40°C (with packaging), R.H. 70% Max.

Test Conditions and equipment:

Z: Impedance Analyzer E4991A or equivalent, -20dBm or 50mV.

DCR: High Accuracy Milliohmmeter-HP4338B or equivalent

I_R: Rated current applied when the chip surface temperature rises just 20°C against chip initial surface temperature. Electric power supplier, current meter, Thermometer.



5101 Hidden Creek Ln, Spicewood TX 78669
Phone: 512-371-6159 Fax: 512-351-8858
For terms and conditions of sales, please visit:
www.abracon.com

REV G: 10/25/2023

ABRACON IS
ISO9001-2015
CERTIFIED

Multilayer Ferrite Chip Bead



ACML-0805 Series

Request Samples



Check Inventory



2.0 x 1.25 x 0.85mm
RoHS/RoHS II Compliant
MSL Level = 1

Electrical Specifications

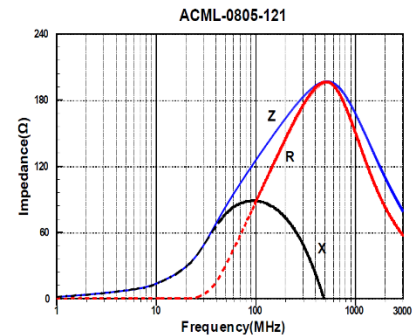
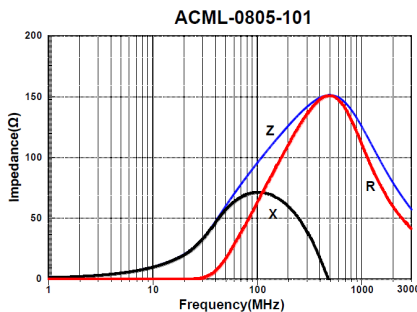
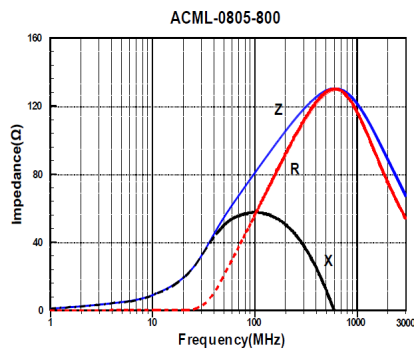
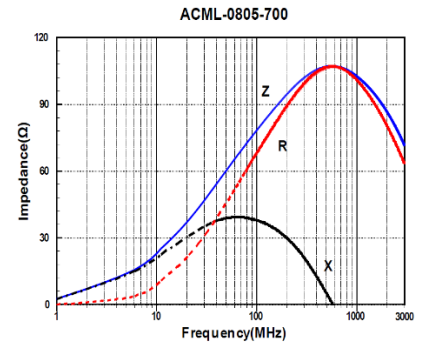
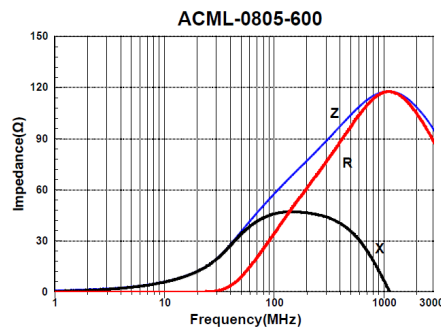
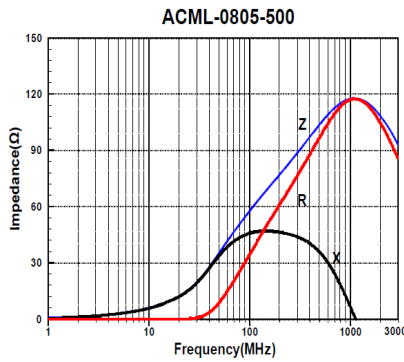
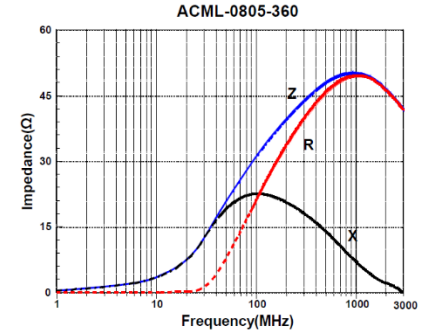
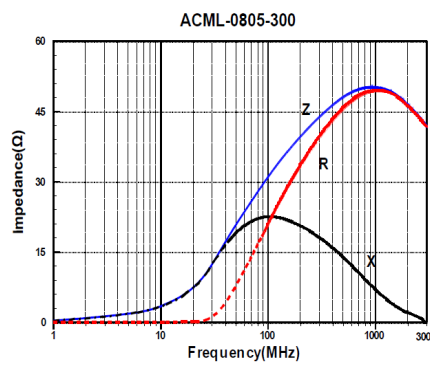
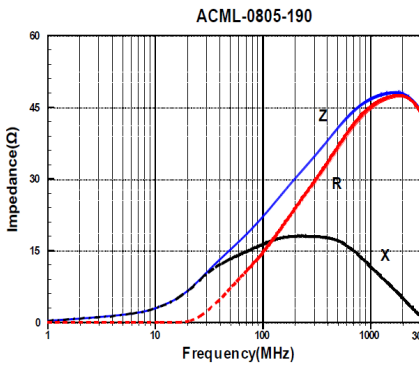
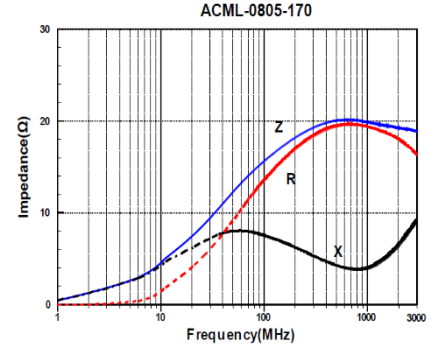
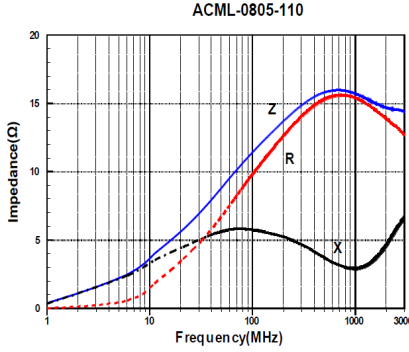
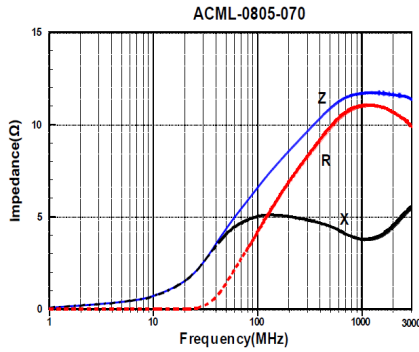

5101 Hidden Creek Ln, Spicewood TX 78669
Phone: 512-371-6159 Fax: 512-351-8858
For terms and conditions of sales, please visit:
www.abracon.com

REV G: 10/25/2023

ABRACON IS
ISO9001-2015
CERTIFIED

Multilayer Ferrite Chip Bead



ACML-0805 Series

Request Samples



Check Inventory



2.0 x 1.25 x 0.85mm
 RoHS/RoHS II Compliant
 MSL Level = 1

Mechanical Specifications

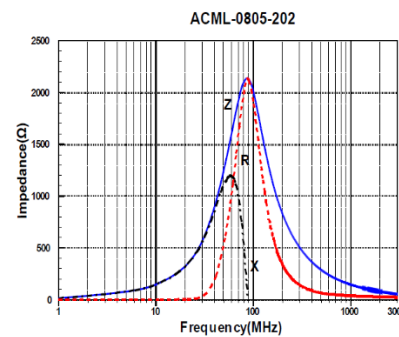
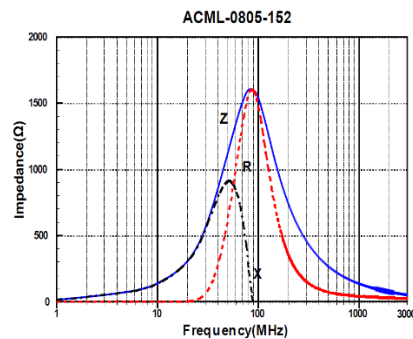
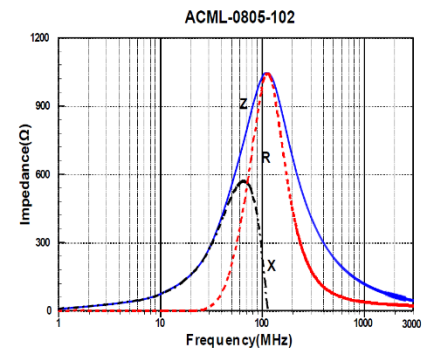
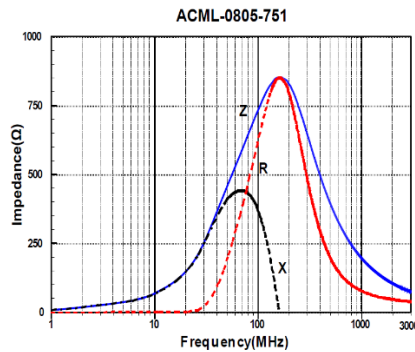
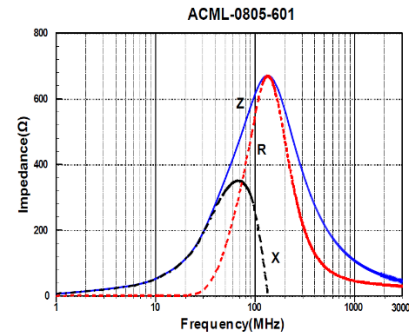
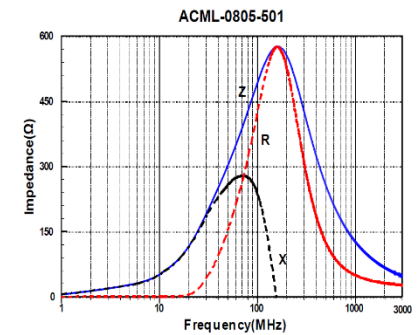
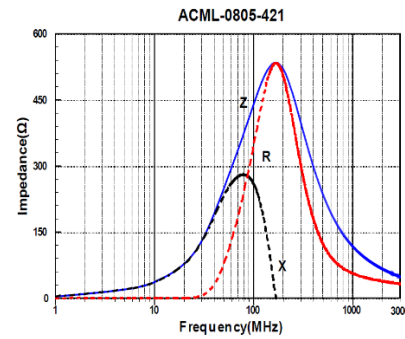
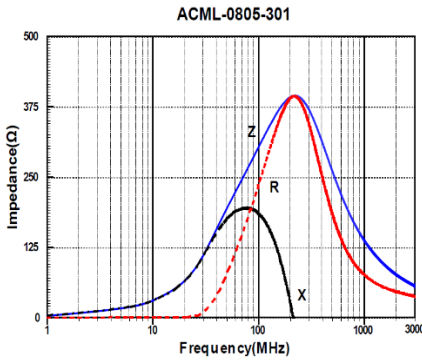
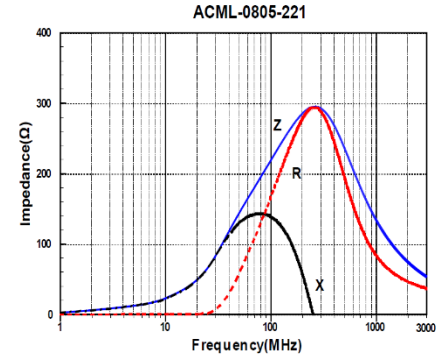
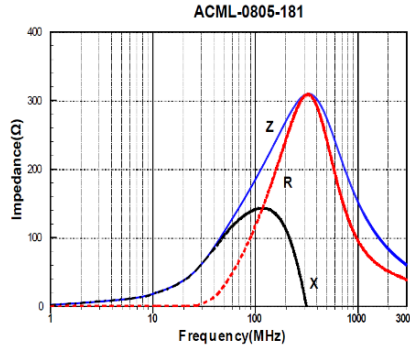
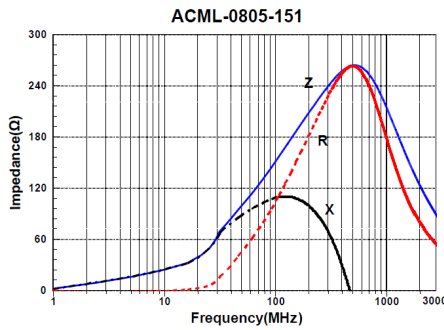

5101 Hidden Creek Ln, Spicewood TX 78669
 Phone: 512-371-6159 Fax: 512-351-8858
 For terms and conditions of sales, please visit:
www.abracon.com

REV G: 10/25/2023

ABRACON IS
 ISO9001-2015
 CERTIFIED

Multilayer Ferrite Chip Bead

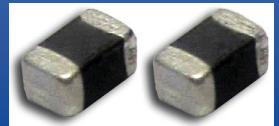

ACML-0805 Series

Request Samples



Check Inventory



2.0 x 1.25 x 0.85mm
RoHS/RoHS II Compliant
 MSL Level = 1

Mechanical Specifications

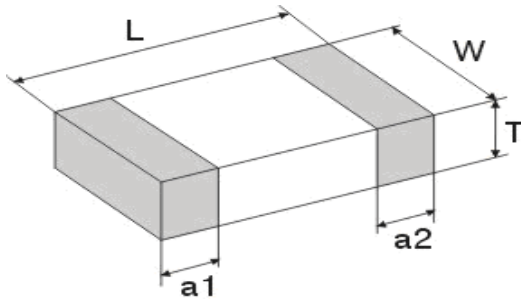

L	W	T	a1, a2
2.00±0.30	1.25±0.20	0.85±0.20	0.50±0.30

Dimensions: mm

Part Identification

ACML-0805 - -

Impedance Code
Please refer to the table above

Packaging
T: Tape and Reel 4kpcs / reel
Blank: Bulk

Materials

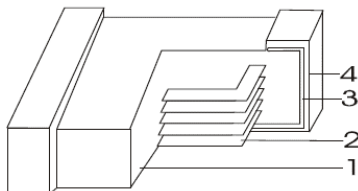

	Part Name	Material
1	Base Material	Ferrite
2	Internal Conductor	Ag
3	Terminal Electrode	Ag
4	Electrode Plating	Ni-Sn

Multilayer Ferrite Chip Bead



ACML-0805 Series

Request Samples



Check Inventory



2.0 x 1.25 x 0.85mm
RoHS/RoHS II Compliant
MSL Level = 1

Reflow Profile

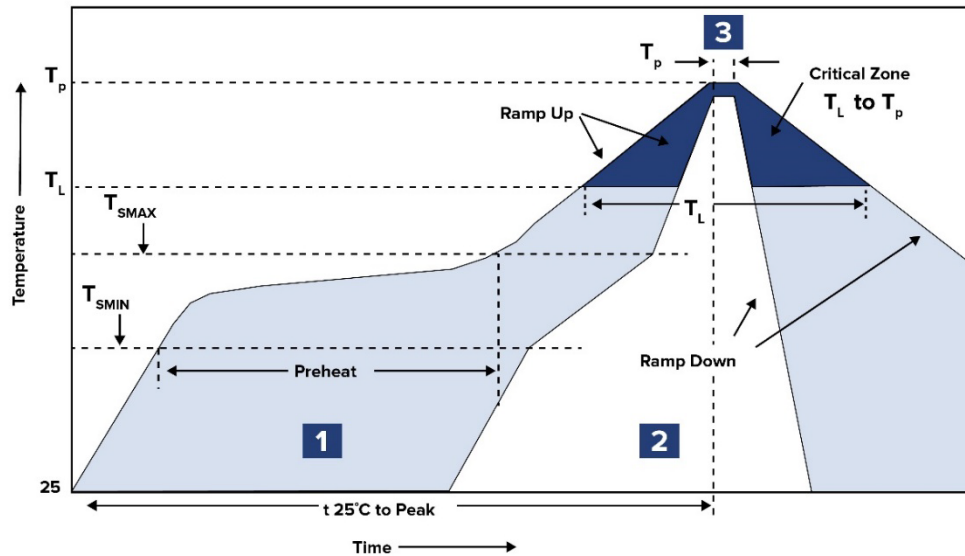

Zone	Description	Temperature	Times
1	Preheat	$T_{SMIN} \sim T_{SMAX}$ 150°C ~ 200°C	60 ~ 180 sec.
2	Reflow	T_L 217°C	60 ~ 150 sec.
3	Peak heat	T_P 260°C	3~4 sec. MAX
T(25°C) to Peak: 8 minutes max.			

Multilayer Ferrite Chip Bead

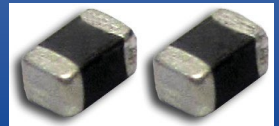

ACML-0805 Series

Request Samples



Check Inventory



2.0 x 1.25 x 0.85mm
RoHS/RoHS II Compliant
MSL Level = 1

Packaging

T: Tape & Reel 4,000pcs/reel

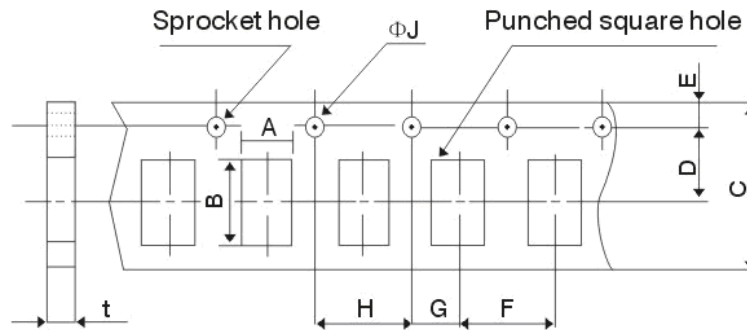

A	B	C	D	E	F	G	H	ΦJ	t (max)
1.5±0.15	2.3±0.2	8.0±0.3	3.5±0.05	1.75±0.1	4.0±0.1	2.0±0.05	4.0±0.1	1.5+0.1/-0	1.1

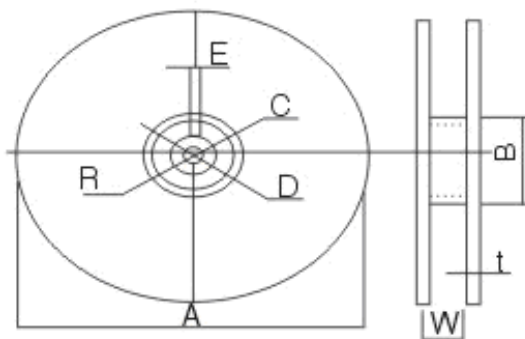

A	178±2
B	58±2
C	13.5±0.5
D	21.0±0.8
E	2.45±0.5
W	8.4±1.15
t	1.2±0.2
R	1.0±0.25

Dimensions: mm

ATTENTION: Abracon LLC's products are COTS – Commercial-Off-The-Shelf products; suitable for Commercial, Industrial and, where designated, Automotive Applications. Abracon's products are not specifically designed for Military, Aviation, Aerospace, Life-dependent Medical applications or any application requiring high reliability where component failure could result in loss of life and/or property. For applications requiring high reliability and/or presenting an extreme operating environment, written consent and authorization from Abracon LLC is required. Please contact Abracon LLC for more information.





5101 Hidden Creek Ln, Spicewood TX 78669
Phone: 512-371-6159 Fax: 512-351-8858
For terms and conditions of sales, please visit:
www.abracon.com

REV G: 10/25/2023

ABRACON IS
ISO9001-2015
CERTIFIED

Looking for pricing, stock, or lifecycle information?

Click below to explore more details on WIN SOURCE:

-  [View ACML-0805-102-T on WIN SOURCE](#)
-  [Abracon LLC Information](#)

Optimize Your Supply Chain with WIN SOURCE Solutions

-  Global Sourcing Solution
-  Obsolete Management
-  Cost Control Management
-  Shortage Management
-  Alternative Solution
-  Excess Inventory Management