



**THE DATASHEET OF  
ESD5V3U1U-02LRH E6327**



# TVS Diodes

Transient Voltage Suppressor Diodes

## ESD5V3U1U Series

Uni-directional Ultra-Low Capacitance ESD / Transient Protection Diode

ESD5V3U1U-02LS  
ESD5V3U1U-02LRH

## Data Sheet

Revision 1.0, 2011-05-27  
Final

Industrial and Multi-Market

**Edition 2011-05-27**

**Published by  
Infineon Technologies AG  
81726 Munich, Germany**

**© 2011 Infineon Technologies AG  
All Rights Reserved.**

### **Legal Disclaimer**

The information given in this document shall in no event be regarded as a guarantee of conditions or characteristics. With respect to any examples or hints given herein, any typical values stated herein and/or any information regarding the application of the device, Infineon Technologies hereby disclaims any and all warranties and liabilities of any kind, including without limitation, warranties of non-infringement of intellectual property rights of any third party.

### **Information**

For further information on technology, delivery terms and conditions and prices, please contact the nearest Infineon Technologies Office ([www.infineon.com](http://www.infineon.com)).

### **Warnings**

Due to technical requirements, components may contain dangerous substances. For information on the types in question, please contact the nearest Infineon Technologies Office.

Infineon Technologies components may be used in life-support devices or systems only with the express written approval of Infineon Technologies, if a failure of such components can reasonably be expected to cause the failure of that life-support device or system or to affect the safety or effectiveness of that device or system. Life support devices or systems are intended to be implanted in the human body or to support and/or maintain and sustain and/or protect human life. If they fail, it is reasonable to assume that the health of the user or other persons may be endangered.

**Revision History**

Page or Item	Subjects (major changes since previous revision)
<b>Revision 1.0, 2011-05-27</b>	

**Trademarks of Infineon Technologies AG**

AURIX™, BlueMoon™, COMNEON™, C166™, CROSSAVE™, CanPAK™, CIPOS™, CoolMOS™, CoolSET™, CORECONTROL™, DAVE™, EasyPIM™, EconoBRIDGE™, EconoDUAL™, EconoPACK™, EconoPIM™, EiceDRIVER™, EUPEC™, FCOS™, HITFET™, HybridPACK™, ISOFACE™, I<sup>2</sup>RF™, IsoPACK™, MIPAQ™, ModSTACK™, my-d™, NovalithIC™, OmniTune™, OptiMOS™, ORIGA™, PROFET™, PRO-SIL™, PRIMARION™, PrimePACK™, RASIC™, ReverSave™, SatRIC™, SIEGET™, SINDRION™, SMARTi™, SmartLEWIS™, TEMPFET™, thinQ!™, TriCore™, TRENCHSTOP™, X-GOLD™, XMM™, X-PMU™, XPOSYS™.

**Other Trademarks**

Advance Design System™ (ADS) of Agilent Technologies, AMBA™, ARM™, MULTI-ICE™, PRIMECELL™, REALVIEW™, THUMB™ of ARM Limited, UK. AUTOSAR™ is licensed by AUTOSAR development partnership. Bluetooth™ of Bluetooth SIG Inc. CAT-iq™ of DECT Forum. COLOSSUS™, FirstGPS™ of Trimble Navigation Ltd. EMV™ of EMVCo, LLC (Visa Holdings Inc.). EPCOS™ of Epcos AG. FLEXGO™ of Microsoft Corporation. FlexRay™ is licensed by FlexRay Consortium. HYPERTERMINAL™ of Hilgraeve Incorporated. IEC™ of Commission Electrotechnique Internationale. IrDA™ of Infrared Data Association Corporation. ISO™ of INTERNATIONAL ORGANIZATION FOR STANDARDIZATION. MATLAB™ of MathWorks, Inc. MAXIM™ of Maxim Integrated Products, Inc. MICROTEC™, NUCLEUS™ of Mentor Graphics Corporation. Mifare™ of NXP. MIPI™ of MIPI Alliance, Inc. MIPS™ of MIPS Technologies, Inc., USA. muRata™ of MURATA MANUFACTURING CO., MICROWAVE OFFICE™ (MWO) of Applied Wave Research Inc., OmniVision™ of OmniVision Technologies, Inc. Openwave™ Openwave Systems Inc. RED HAT™ Red Hat, Inc. RFMD™ RF Micro Devices, Inc. SIRIUS™ of Sirius Sattelite Radio Inc. SOLARIS™ of Sun Microsystems, Inc. SPANSION™ of Spansion LLC Ltd. Symbian™ of Symbian Software Limited. TAIYO YUDEN™ of Taiyo Yuden Co. TEAKLITE™ of CEVA, Inc. TEKTRONIX™ of Tektronix Inc. TOKO™ of TOKO KABUSHIKI KAISHA TA. UNIX™ of X/Open Company Limited. VERILOG™, PALLADIUM™ of Cadence Design Systems, Inc. VLYNQ™ of Texas Instruments Incorporated. VXWORKS™, WIND RIVER™ of WIND RIVER SYSTEMS, INC. ZETEX™ of Diodes Zetex Limited.

Last Trademarks Update 2010-06-09

## Table of Contents

	<b>Table of Contents</b> .....	4
	<b>List of Figures</b> .....	5
	<b>List of Tables</b> .....	6
<b>1</b>	<b>Uni-directional Ultra-Low Capacitance ESD / Transient Protection Diode</b> .....	7
1.1	Features .....	7
1.2	Application Examples .....	7
<b>2</b>	<b>Product Description</b> .....	7
<b>3</b>	<b>Characteristics</b> .....	8
3.1	Electrical Characteristics at $T_A = 25\text{ °C}$ , unless otherwise specified .....	8
3.2	Typical Characteristics at $T_A=25\text{°C}$ , unless otherwise specified .....	10
<b>4</b>	<b>Application Information</b> .....	15
<b>5</b>	<b>Ordering Information Scheme (Examples)</b> .....	16
<b>6</b>	<b>Package Information</b> .....	17
6.1	PG-TSSLP-2-1 (mm) <a href="#">[3]</a> .....	17
6.2	PG-TSLP-2-7 (mm) <a href="#">[3]</a> .....	18
	<b>Terminology</b> .....	19
	<b>References</b> .....	20

## List of Figures

Figure 1	Pin Configuration and Schematic Diagram.....	7
Figure 2	Definitions of Electrical Characteristics.....	8
Figure 3	Reverse current $I_R = f(T_A)$ , $V_R = 5.3\text{ V}$ , from pin 1 to pin 2.....	10
Figure 4	Line capacitance $C_L = f(V_R)$ , $f = 1\text{MHz}$ , from pin 1 to pin 2.....	10
Figure 5	Line capacitance $C_L = f(f)$ , from pin 1 to pin 2.....	11
Figure 6	Line capacitance $C_L = f(T_A)$ , from pin 1 to pin 2.....	11
Figure 7	Clamping voltage $V_{TLP} = f(I_{TLP})$ , from pin 1 to pin 2[1].....	12
Figure 8	Forward clamping voltage $V_{TLP} = f(I_{TLP})$ , from pin 2 to pin 1[1].....	12
Figure 9	IEC61000-4-2: $V_{CL} = f(t)$ , 8 kV positive pulse from pin 1 to pin 2.....	13
Figure 10	IEC61000-4-2: $V_{CL} = f(t)$ , 8 kV negative pulse from pin 1 to pin 2.....	13
Figure 11	IEC61000-4-2: $V_{CL} = f(t)$ , 15 kV positive pulse from pin 1 to pin 2.....	14
Figure 12	IEC61000-4-2: $V_{CL} = f(t)$ , 15 kV negative pulse from pin 1 to pin 2.....	14
Figure 13	Single line, uni-directional ESD / Transient protection[2].....	15
Figure 14	Ordering information scheme.....	16
Figure 15	PG-TSSLP-2-1: Package overview.....	17
Figure 16	PG-TSSLP-2-1: Footprint.....	17
Figure 17	PG-TSSLP-2-1: Packing.....	17
Figure 18	PG-TSSLP-2-1: Marking (example).....	17
Figure 19	PG-TSLP-2-7: Package Overview.....	18
Figure 20	PG-TSLP-2-7: Footprint.....	18
Figure 21	PG-TSLP-2-7: Packing.....	18
Figure 22	PG-TSLP-2-7: Marking (example).....	18

## List of Tables

Table 1	Ordering Information . . . . .	7
Table 2	Maximum Rating at $T_A = 25\text{ }^\circ\text{C}$ , unless otherwise specified . . . . .	8
Table 3	DC Characteristics at $T_A = 25\text{ }^\circ\text{C}$ , unless otherwise specified . . . . .	8
Table 4	RF Characteristics at $T_A = 25\text{ }^\circ\text{C}$ , unless otherwise specified . . . . .	9
Table 5	ESD Characteristics at $T_A = 25\text{ }^\circ\text{C}$ , unless otherwise specified . . . . .	9

# 1 Uni-directional Ultra-Low Capacitance ESD / Transient Protection Diode

## 1.1 Features

- ESD / Transient protection of high speed data lines exceeding
  - IEC61000-4-2 (ESD):  $\pm 20$  kV (air / contact)
  - IEC61000-4-4 (EFT): 2.5 kV / 50 A (5/50 ns)
  - IEC61000-4-5 (surge): 3 A (8/20  $\mu$ s)
- Maximum working voltage:  $V_{RWM} = 5.3$  V
- Ultra low capacitance:  $C_L = 0.4$  pF (typical)
- Low clamping voltage, low dynamic resistance  $R_{DYN} = 0.6 \Omega$  (typical)
- Very small form factor down to  $0.62 \times 0.32 \times 0.31$  mm<sup>3</sup>
- Pb-free (RoHS compliant) and halogen free package



## 1.2 Application Examples

- USB 2.0, Mobile HDMI Link, MDDI, MIPI, etc.
- HDMI, DisplayPort, DVI, Ethernet, Firewire, S-ATA

# 2 Product Description

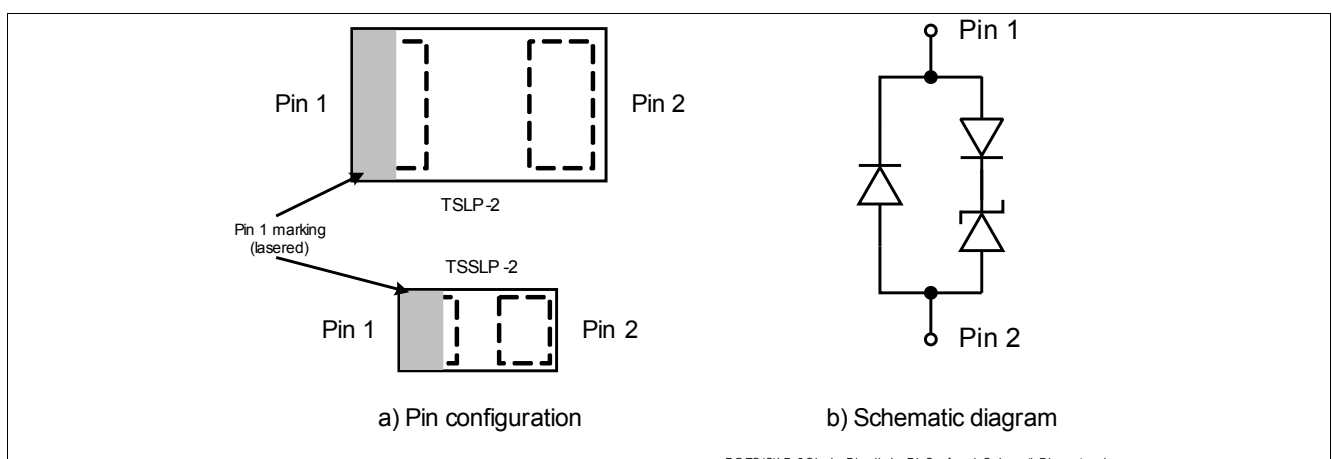

PG-TS(SILP-2)Single Die diode\_PinConf\_and\_SchematicDiaqvst.vsd

Figure 1 Pin Configuration and Schematic Diagram

Table 1 Ordering Information

Type	Package	Configuration	Marking code
ESD5V3U1U-02LS	PG-TSSLP-2-1	1 line, uni-directional	L
ESD5V3U1U-02LRH	PG-TSLP-2-7	1 line, uni-directional	E5

### 3 Characteristics

**Table 2** Maximum Rating at  $T_A = 25\text{ }^\circ\text{C}$ , unless otherwise specified

Parameter	Symbol	Values			Unit
		Min.	Typ.	Max.	
ESD (air / contact) discharge <sup>1)</sup>	$V_{ESD}$	–	–	20	kV
Peak pulse current ( $t_p = 8/20\ \mu\text{s}$ ) <sup>2)</sup>	$I_{PP}$	–	–	3	A
Operating temperature range	$T_{OP}$	-55	–	125	$^\circ\text{C}$
Storage temperature	$T_{stg}$	-65	–	150	$^\circ\text{C}$

1)  $V_{ESD}$  according to IEC61000-4-2

2)  $I_{PP}$  according to IEC61000-4-5

#### 3.1 Electrical Characteristics at $T_A = 25\text{ }^\circ\text{C}$ , unless otherwise specified

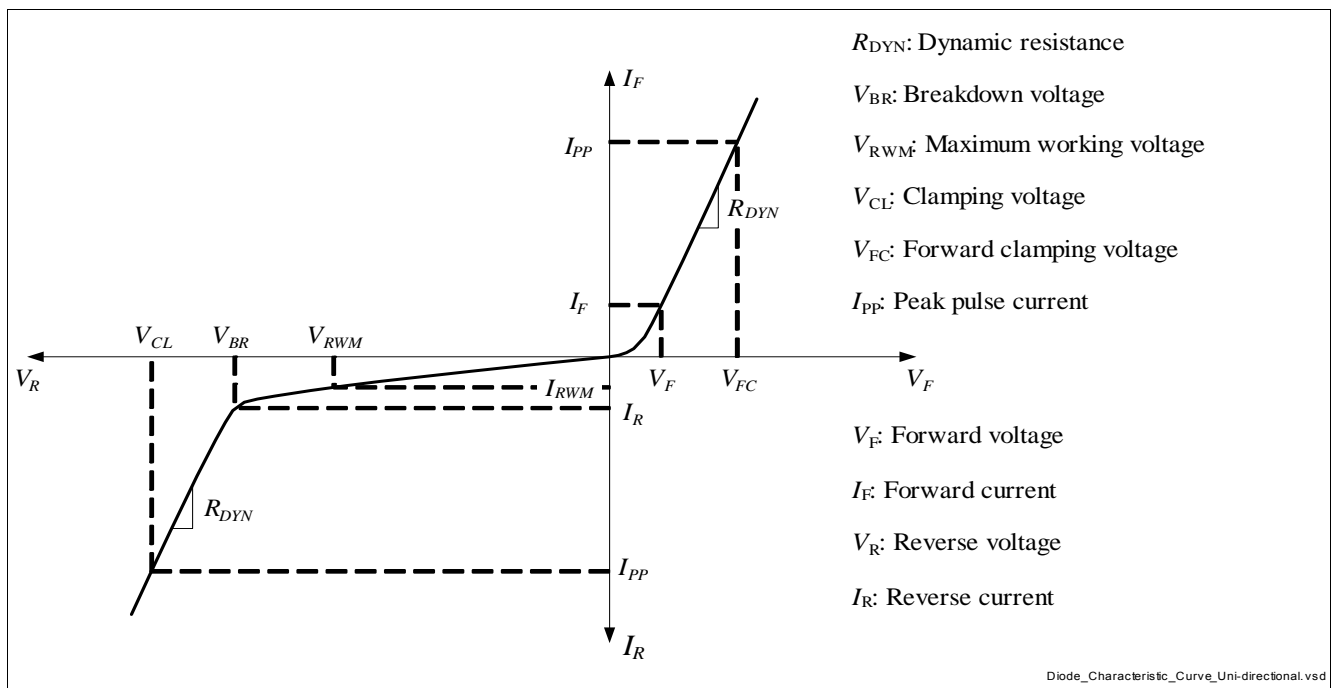

**Figure 2** Definitions of Electrical Characteristics

**Table 3** DC Characteristics at  $T_A = 25\text{ }^\circ\text{C}$ , unless otherwise specified

Parameter	Symbol	Values			Unit	Note / Test Condition
		Min.	Typ.	Max.		
Reverse working voltage	$V_{RWM}$	–	–	5.3	V	Pin 1 to Pin 2
Breakdown voltage	$V_{BR}$	6	–	–	V	$I_{BR} = 1\text{ mA}$ , from Pin 1 to Pin 2
Reverse current	$I_R$	–	<10	100	nA	$V_R = 5.3\text{ V}$ , from Pin 1 to Pin 2

**Table 4 RF Characteristics at  $T_A = 25\text{ °C}$ , unless otherwise specified**

Parameter	Symbol	Values			Unit	Note / Test Condition
		Min.	Typ.	Max.		
Line capacitance <sup>1)</sup>	$C_L$	–	0.4	0.6	pF	$V_R = 0\text{ V}, f = 1\text{ MHz}$
Serie inductance	$L_S$	–	0.2	–	nH	ESD5V3U1U-02LS
		–	0.4	–	nH	ESD5V3U1U-02LRH

1) Total capacitance line to ground

**Table 5 ESD Characteristics at  $T_A = 25\text{ °C}$ , unless otherwise specified**

Parameter	Symbol	Values			Unit	Note / Test Condition
		Min.	Typ.	Max.		
Clamping voltage	$V_{CL}$	–	19	–	V	$I_{PP} = 16\text{ A}$ , from Pin 1 to Pin 2
		–	28	–	V	$I_{PP} = 30\text{ A}$ , from Pin 1 to Pin 2
Forward clamping voltage	$V_{FC}$	–	10	–	V	$I_{PP} = 16\text{ A}$ , from Pin 2 to Pin 1
		–	17	–	V	$I_{PP} = 30\text{ A}$ , from Pin 2 to Pin 1
Dynamic resistance <sup>1)</sup>	$R_{DYN}$	–	0.6	–	V	Pin 1 to Pin 2
		–	0.5	–	V	Pin 2 to Pin 1

1) Please refer to Application Note AN210[1]. TLP parameter:  $Z_0 = 50\ \Omega$ ,  $t_p = 100\text{ ns}$ ,  $t_r = 300\text{ ps}$ , averaging window:  $t_1 = 30\text{ ns}$  to  $t_2 = 60\text{ ns}$ , extraction of dynamic resistance using least squares fit of TLP characteristics between  $I_{PP1} = 10\text{ A}$  and  $I_{PP2} = 40\text{ A}$ .

3.2 Typical Characteristics at  $T_A=25^\circ\text{C}$ , unless otherwise specified

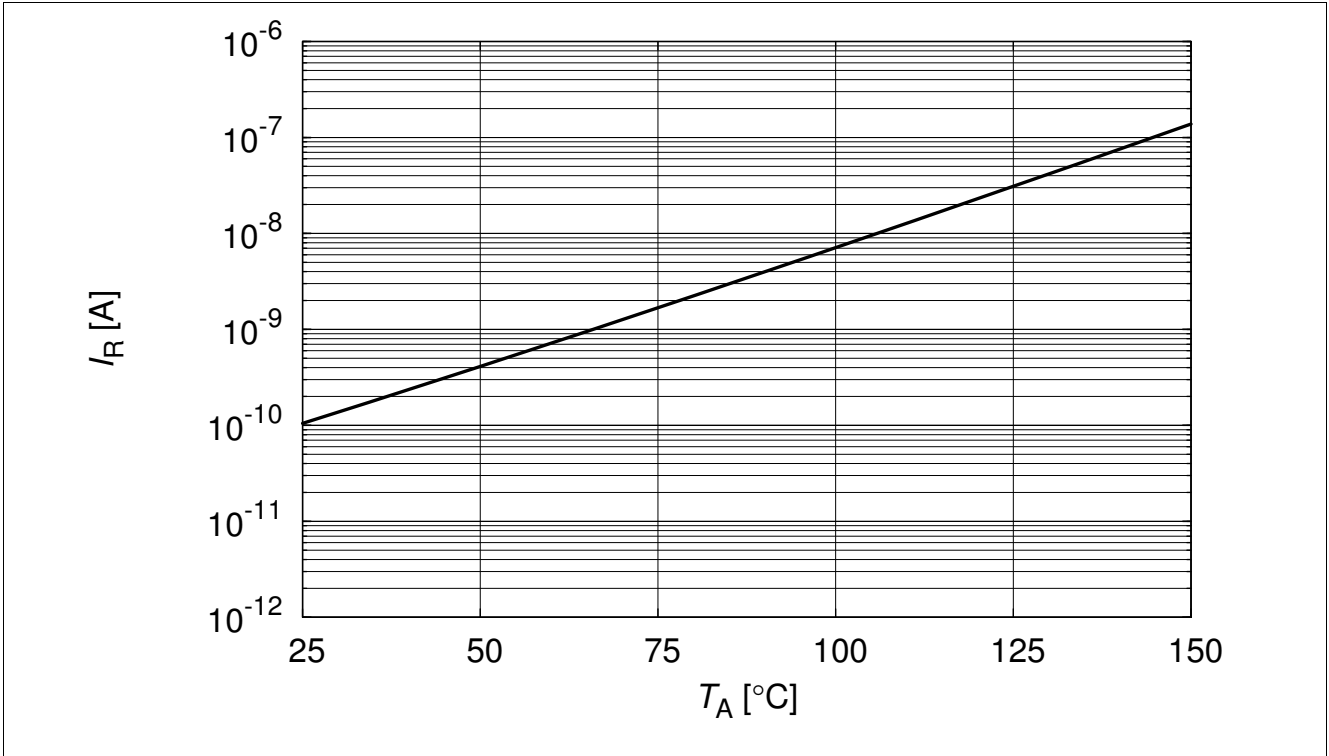

Figure 3 Reverse current  $I_R = f(T_A)$ ,  $V_R = 5.3\text{ V}$ , from pin 1 to pin 2

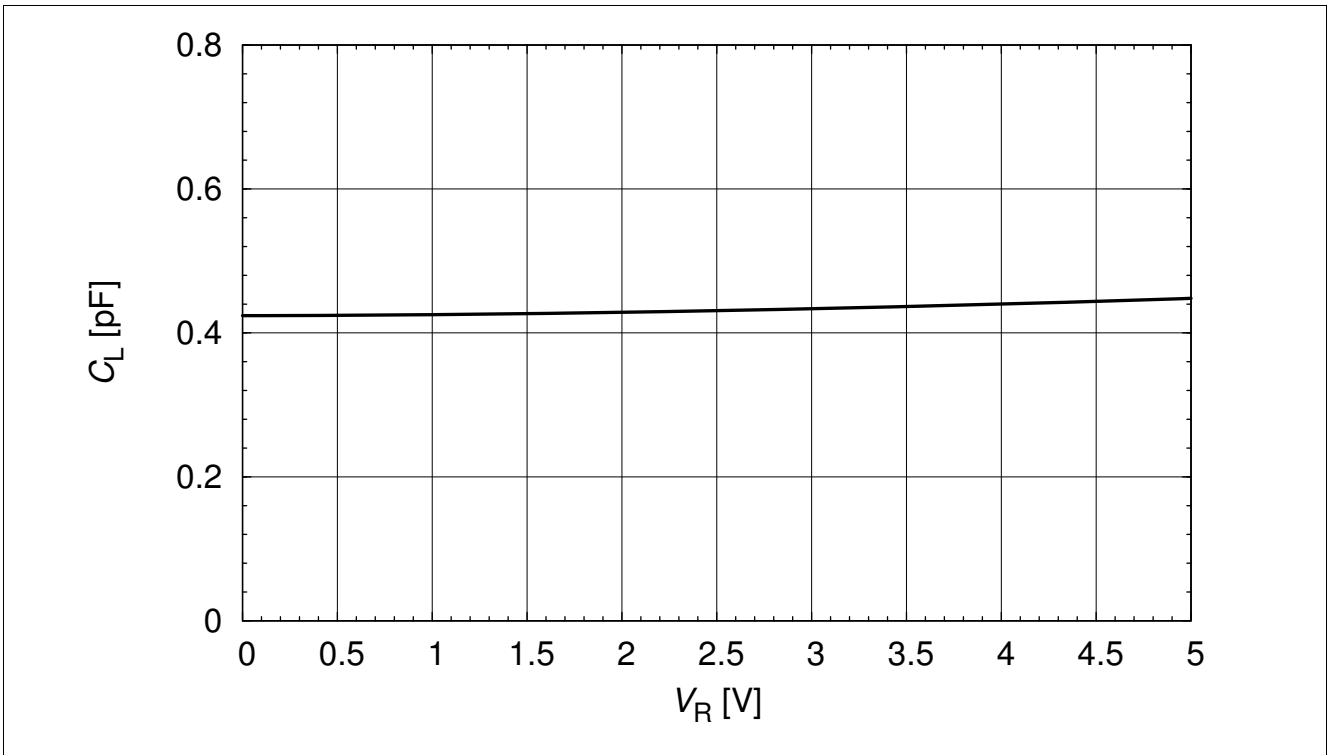

Figure 4 Line capacitance  $C_L = f(V_R)$ ,  $f = 1\text{ MHz}$ , from pin 1 to pin 2

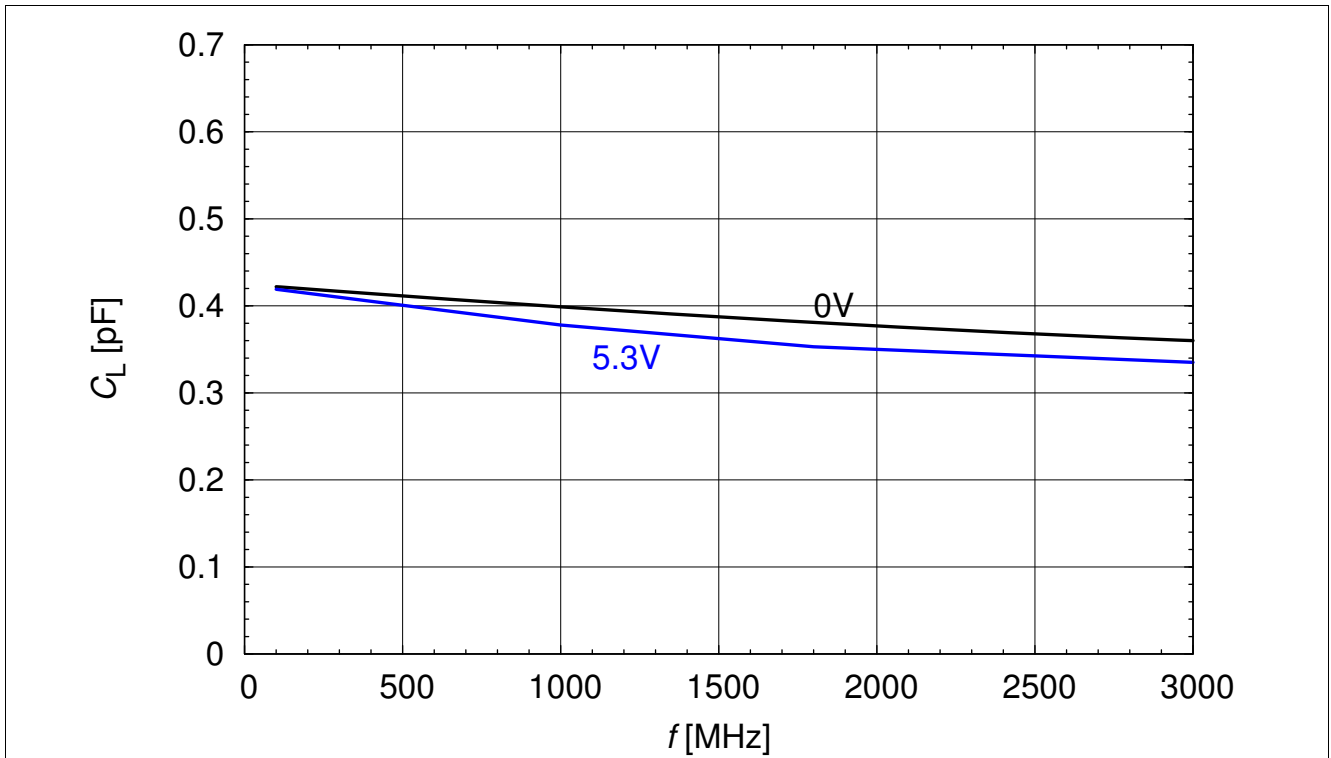

Figure 5 Line capacitance  $C_L = f(f)$ , from pin 1 to pin 2

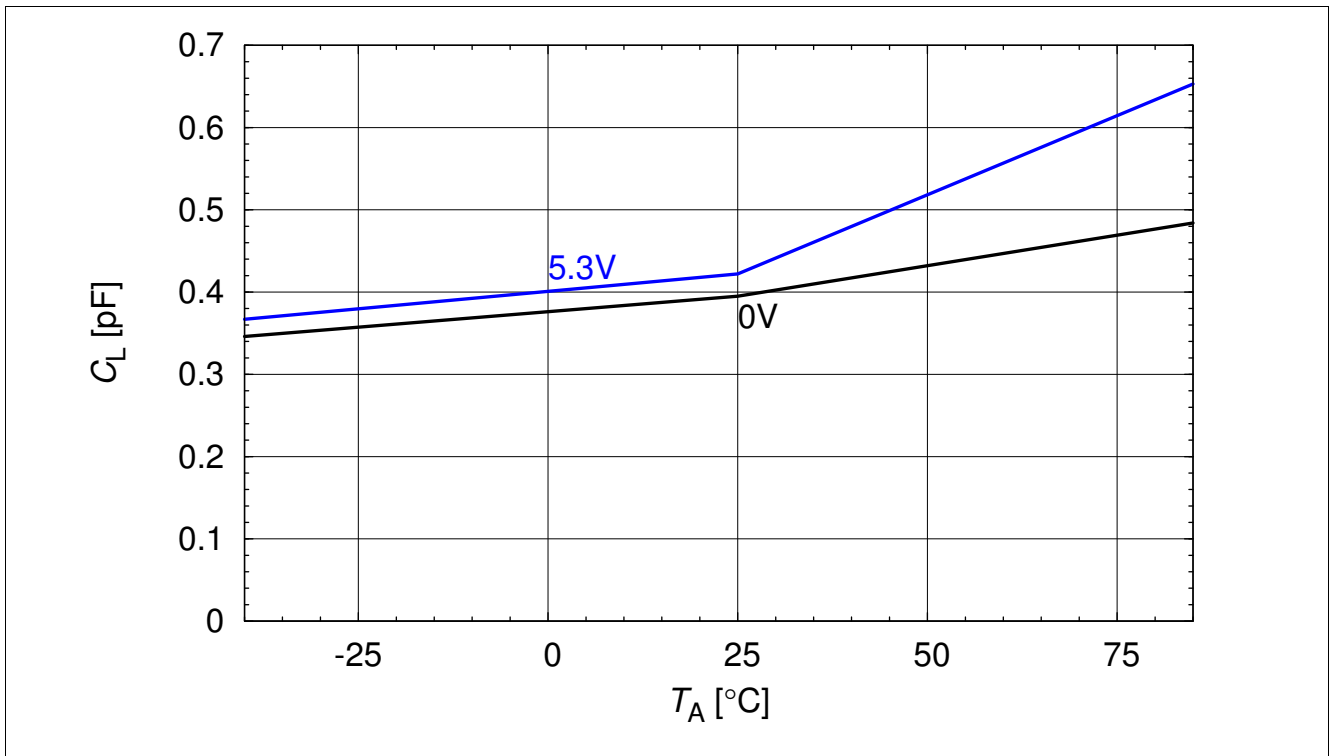

Figure 6 Line capacitance  $C_L = f(T_A)$ , from pin 1 to pin 2

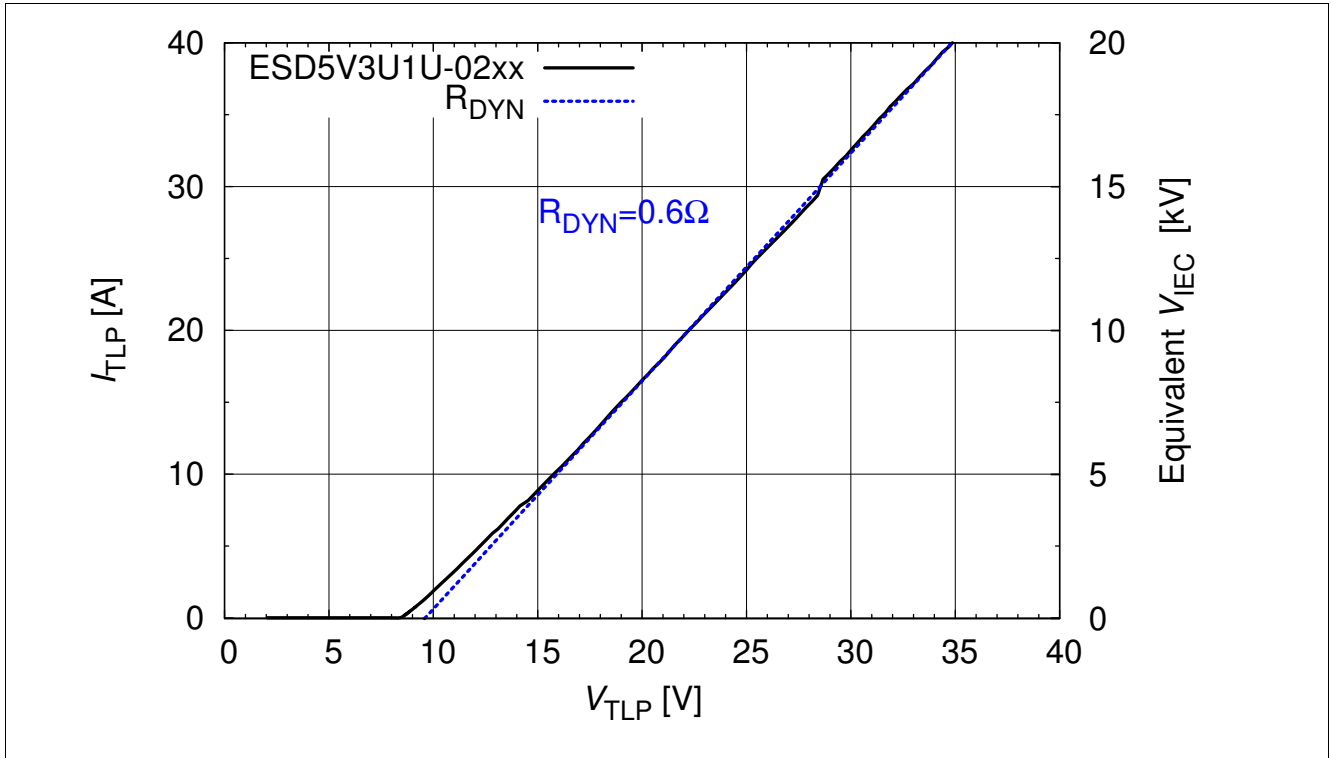

Figure 7 Clamping voltage  $V_{TLP} = f(I_{TLP})$ , from pin 1 to pin 2[1]

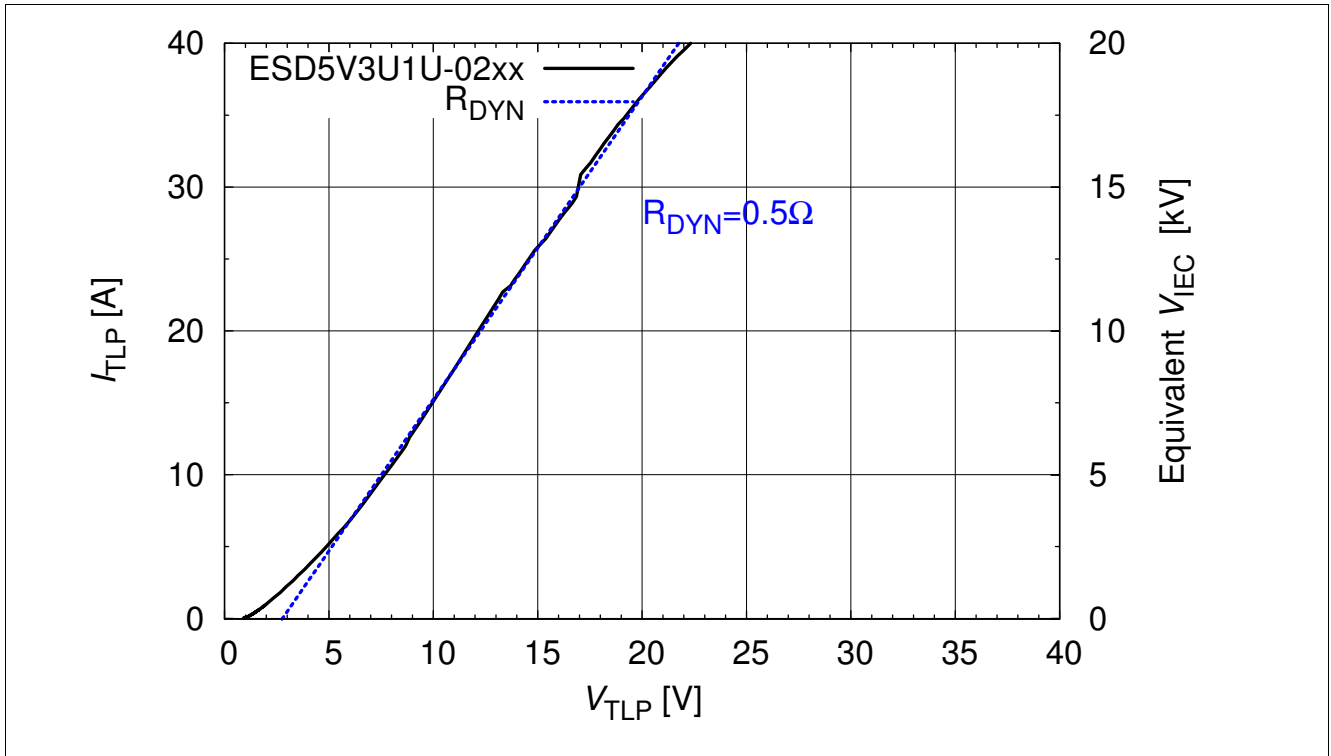

Figure 8 Forward clamping voltage  $V_{TLP} = f(I_{TLP})$ , from pin 2 to pin 1[1]

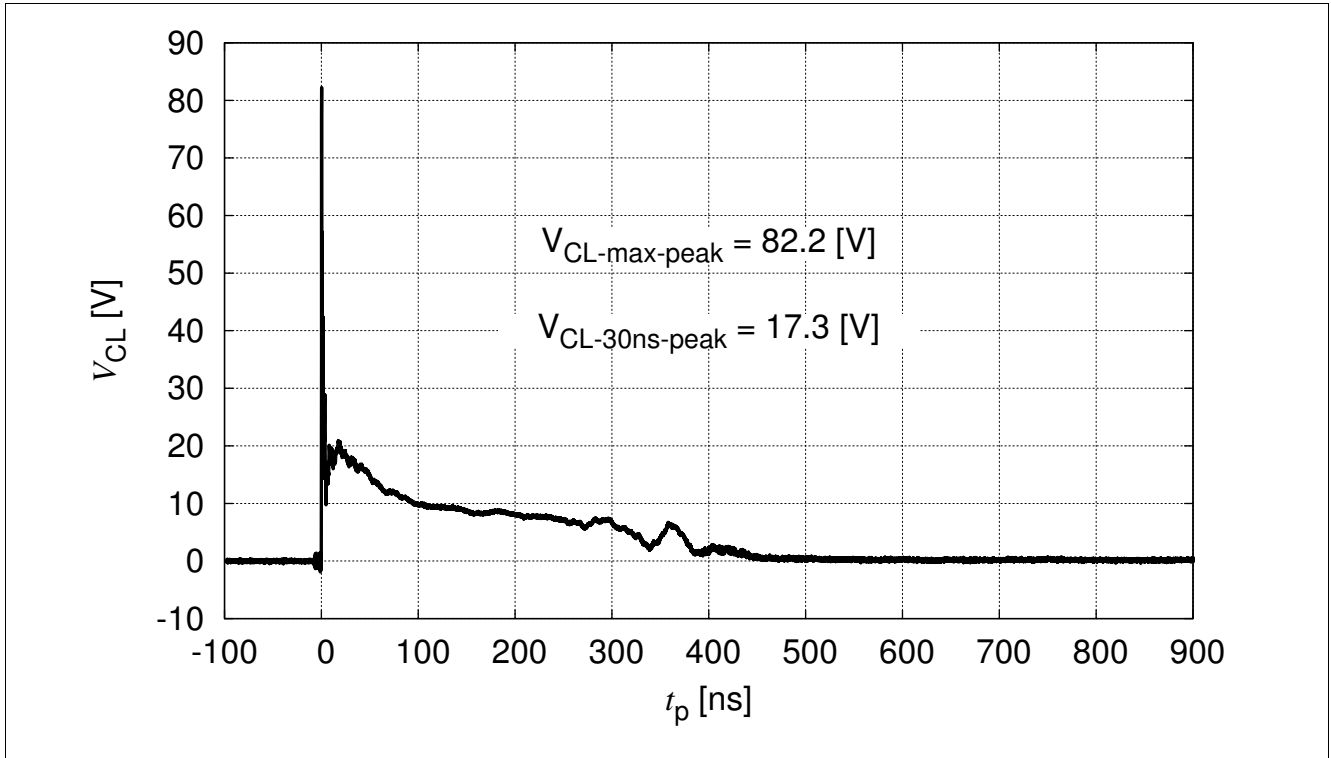

Figure 9 IEC61000-4-2:  $V_{CL} = f(t)$ , 8 kV positive pulse from pin 1 to pin 2

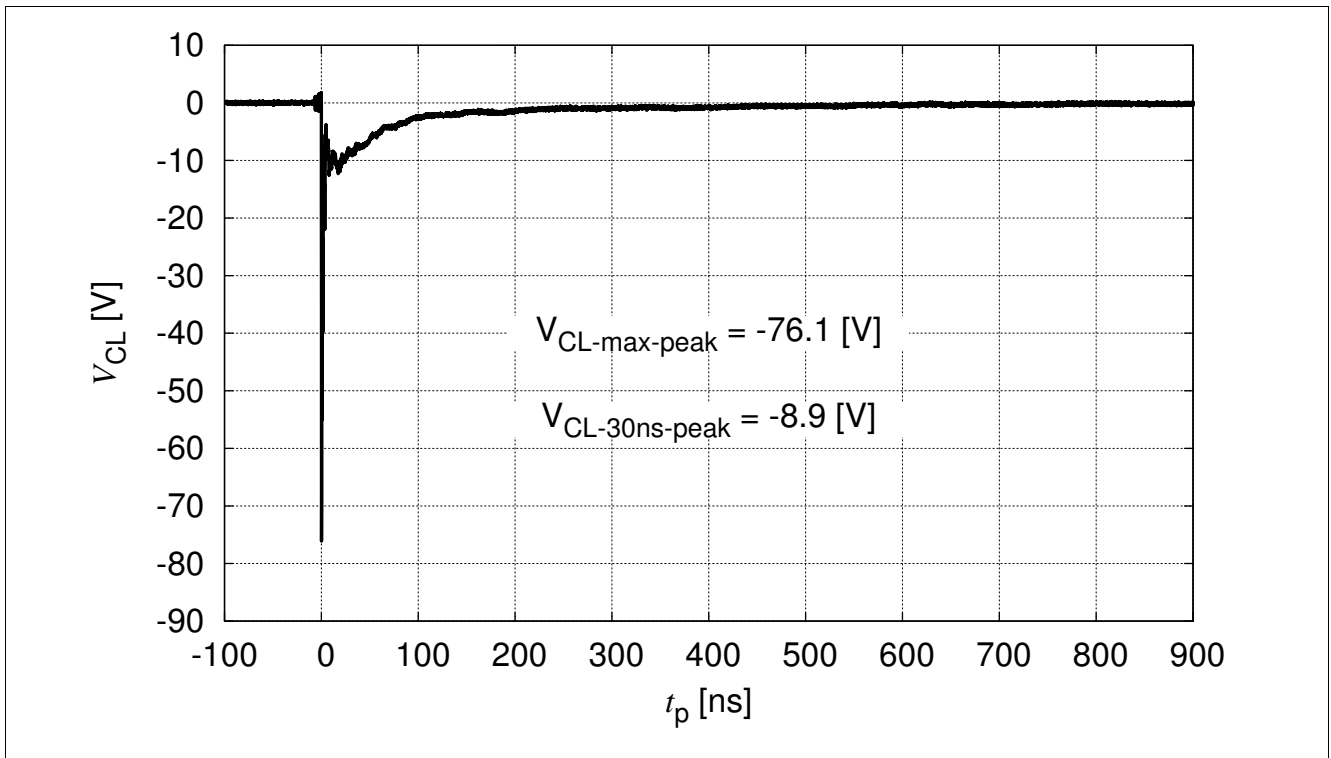

Figure 10 IEC61000-4-2:  $V_{CL} = f(t)$ , 8 kV negative pulse from pin 1 to pin 2

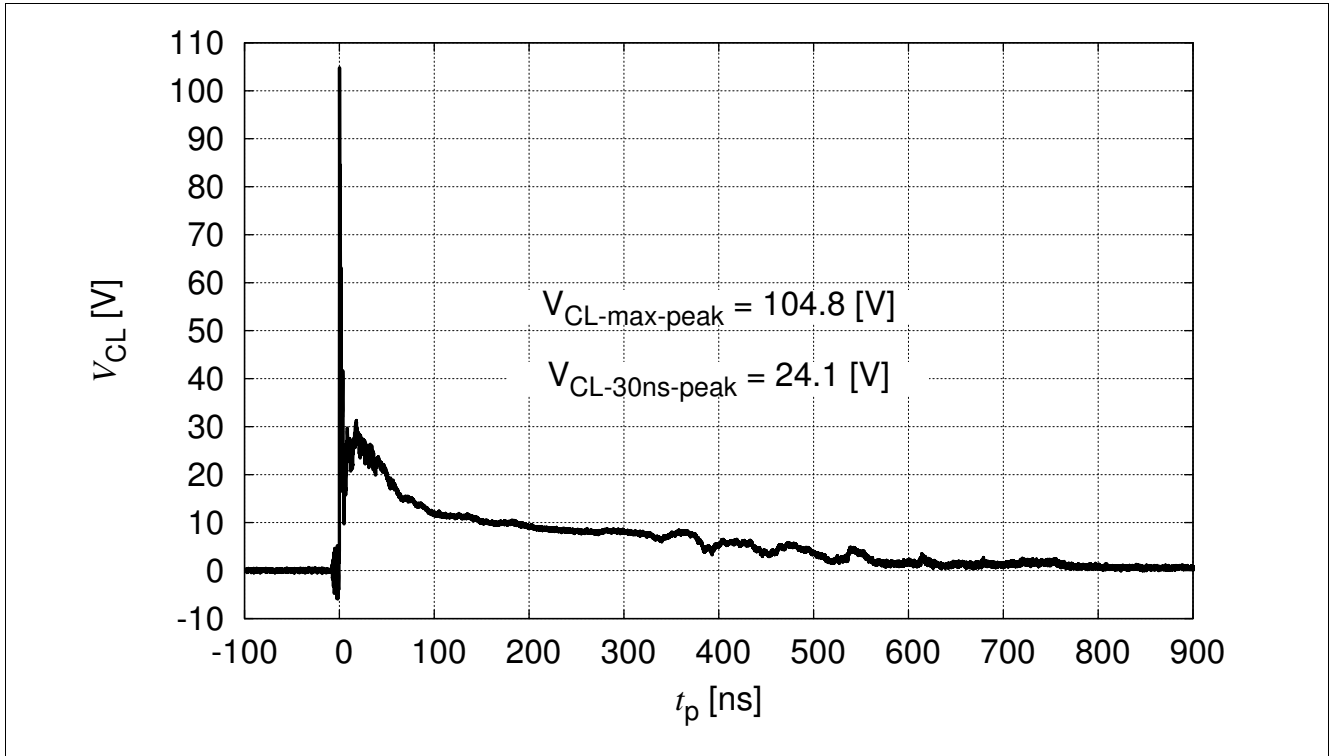

Figure 11 IEC61000-4-2:  $V_{CL} = f(t)$ , 15 kV positive pulse from pin 1 to pin 2

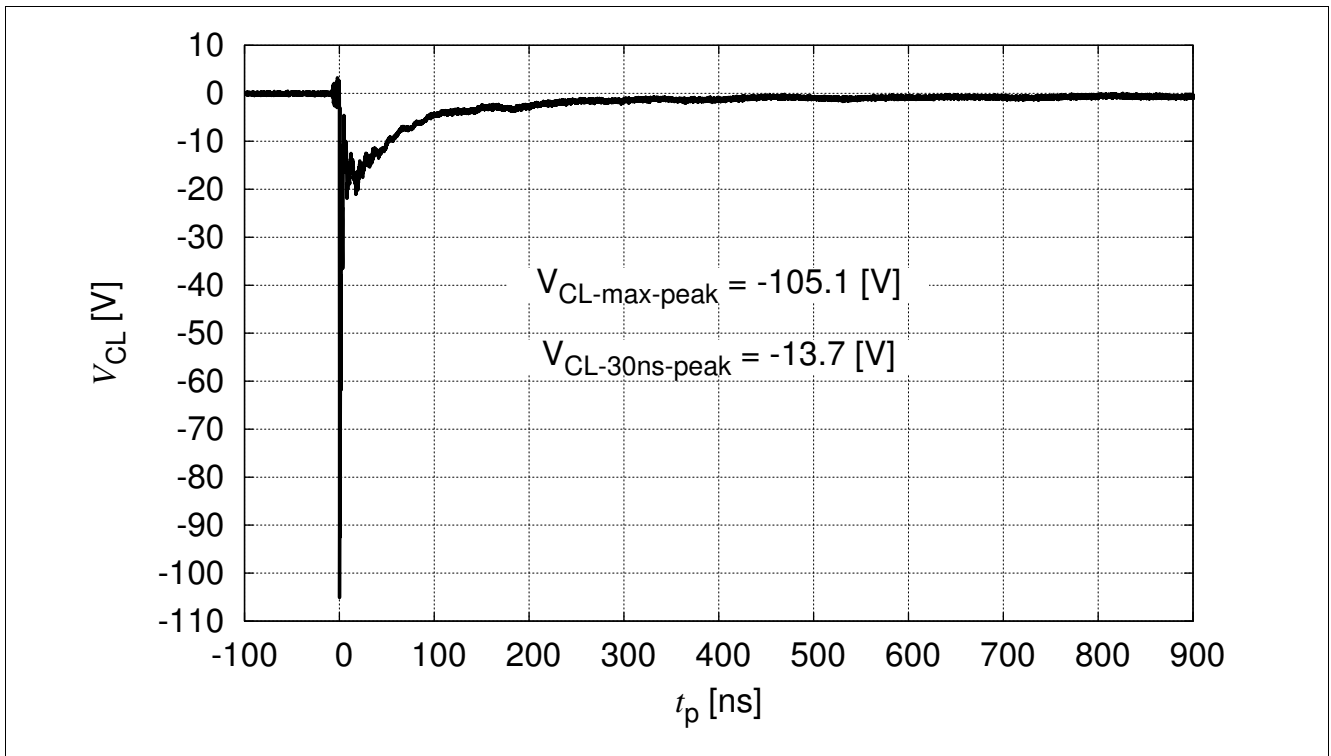

Figure 12 IEC61000-4-2:  $V_{CL} = f(t)$ , 15 kV negative pulse from pin 1 to pin 2

## 4 Application Information

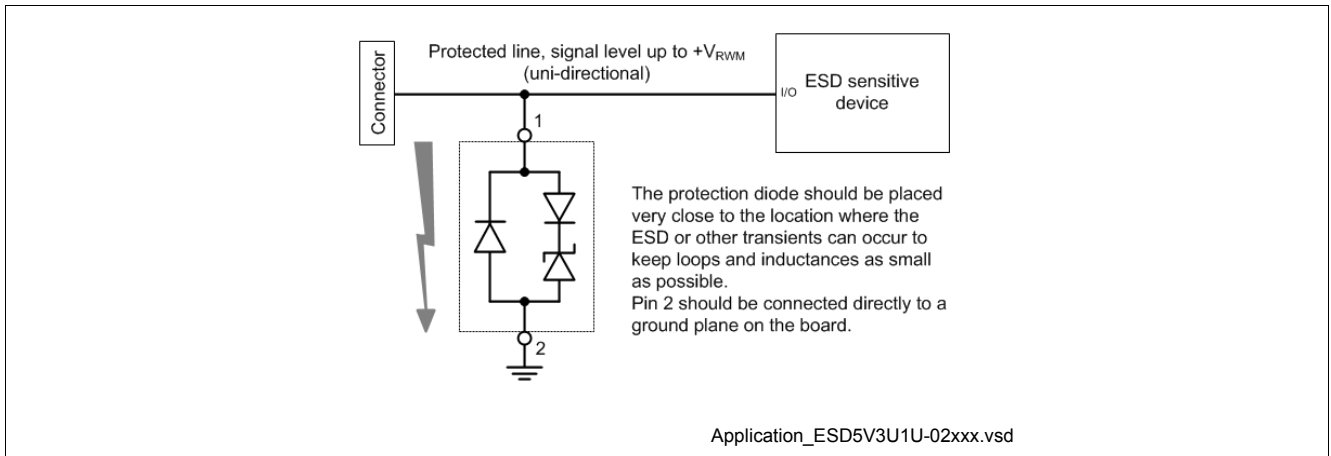

Figure 13 Single line, uni-directional ESD / Transient protection[2]

## 5 Ordering Information Scheme (Examples)

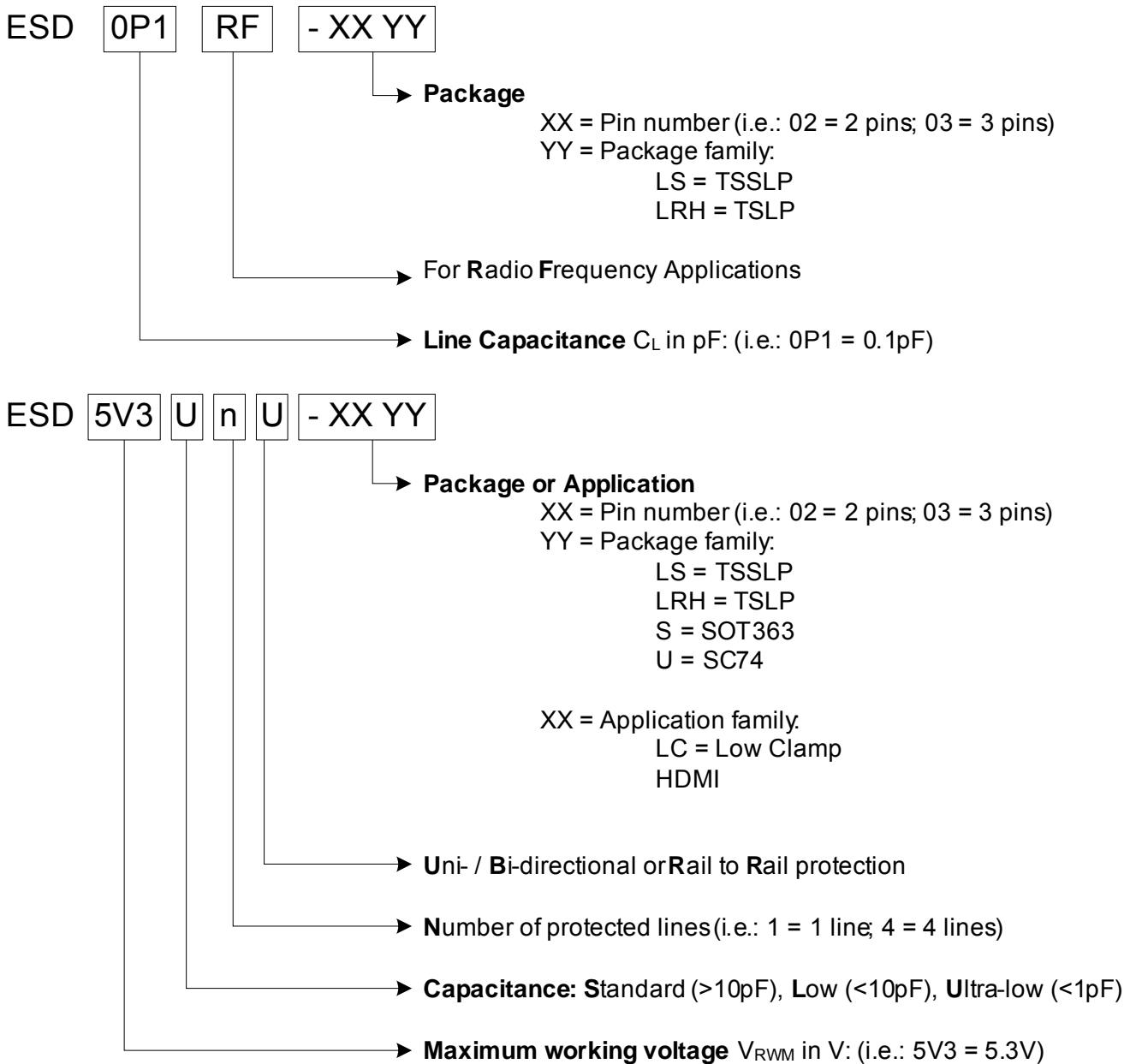

Figure 14 Ordering information scheme

## 6 Package Information

### 6.1 PG-TSSLP-2-1 (mm)[3]

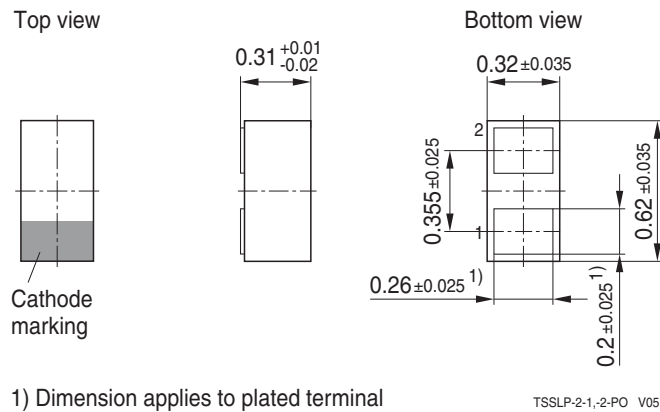

Figure 15 PG-TSSLP-2-1: Package overview

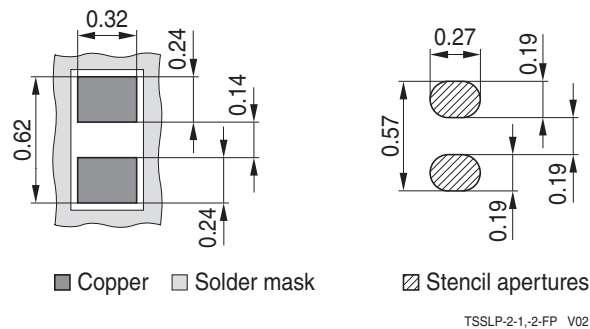

Figure 16 PG-TSSLP-2-1: Footprint

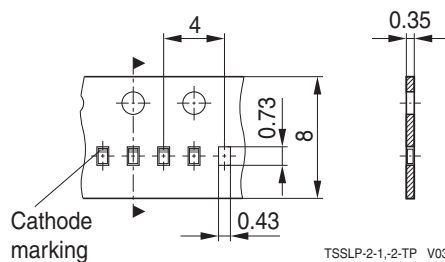

Figure 17 PG-TSSLP-2-1: Packing

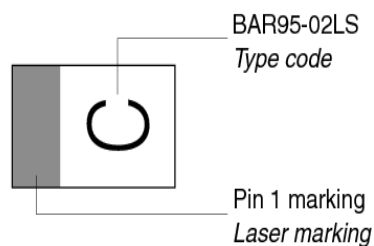

Figure 18 PG-TSSLP-2-1: Marking (example)

6.2 PG-TSLP-2-7 (mm)[3]

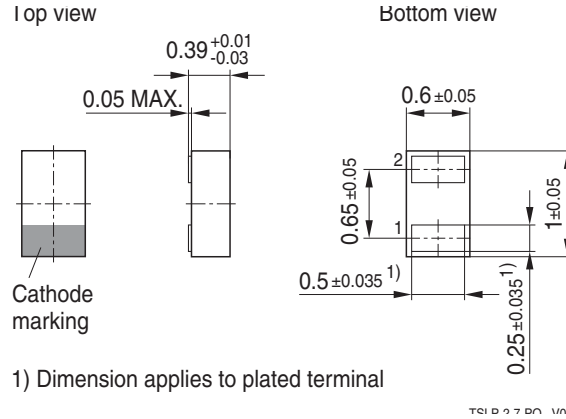

Figure 19 PG-TSLP-2-7: Package Overview

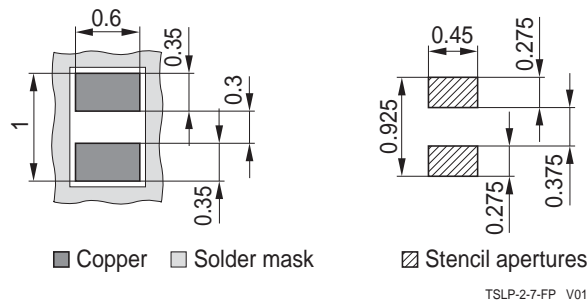

Figure 20 PG-TSLP-2-7: Footprint

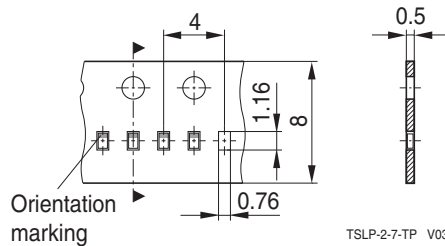

Figure 21 PG-TSLP-2-7: Packing

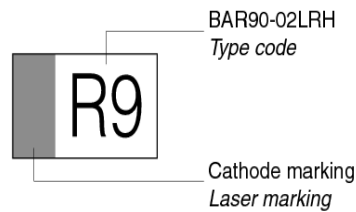

Figure 22 PG-TSLP-2-7: Marking (example)

## Terminology

$C_L$	Line capacitance
DVI	Digital Visual Interface
EFT	Electrical Fast Transient
ESD	Electrostatic Discharge
HDMI	High Definition Multimedia Interface
IEC	International Electrotechnical Commission
$I_{PP}$	Peak pulse current
$I_R$	Reverse current
$I_{RWM}$	Maximum Reverse working Current
$L_S$	Serial inductance
MDDI	Mobile Display Digital Interface
MIPI	Mobile Industrial Processor Interface
<b>RoHS</b>	Restriction of Hazardous Substances Directive
S-ATA	Serial Advanced Technology Attachment
$T_A$	Ambient temperature
$T_{OP}$	Operation temperature
$t_p$	Pulse duration
$T_{stg}$	Storage temperature
USB	Universal Serial Bus
$V_{BR}$	Breakdown Voltage
$V_{CL}$	Reverse clamping voltage
$V_{ESD}$	Electrostatic discharge voltage
$V_{FC}$	Forward Clamping Voltage
$V_R$	Reverse voltage
$V_{RWM}$	Maximum Reverse Working Voltage

**References**

- [1] Infineon AG - **Application Note AN210**: Effective ESD Protection Design at System Level Using VF-TLP
- [2] Infineon AG - **Application Note AN140**: ESD Protection for Digital High-Speed Interfaces (HDMI, FireWire, ...) using ESD5V3U1U)
- [3] Infineon AG - Recommendations for PCB Assembly of Infineon TSLP and TSSLP Package

[www.infineon.com](http://www.infineon.com)

Published by Infineon Technologies AG

## Looking for pricing, stock, or lifecycle information?

Click below to explore more details on WIN SOURCE:

 [View ESD5V3U1U-02LRH E6327 on WIN SOURCE](#)

 [Infineon Technologies](#) Information

## Optimize Your Supply Chain with WIN SOURCE Solutions

-  Global Sourcing Solution
-  Obsolete Management
-  Cost Control Management
-  Shortage Management
-  Alternative Solution
-  Excess Inventory Management