



**THE DATASHEET OF  
406C35D16M00000**



# Model 406

## Surface Mount Quartz Crystal

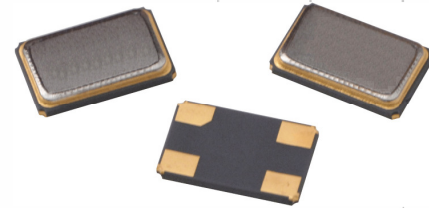

Part Dimensions:  
6.0 x 3.5 x 1.2mm • 68mg

### Features

- Hermetic Ceramic Surface Mount Package
- Fundamental Crystal Design
- Frequency Range 7.0 – 54MHz
- Frequency Tolerance,  $\pm 30$ ppm Standard
- Frequency Stability,  $\pm 50$ ppm Standard
- Operating Temperature Range to  $-40^{\circ}\text{C}$  to  $+85^{\circ}\text{C}$
- Tape and Reel Packaging, EIA-481

Standard Frequencies – see Page 5 for common frequencies.  
\* Check with factory for availability of frequencies not listed.

### Applications

- IoT and IIoT Applications
- Wireless Communications
- FPGA/Microcontrollers
- USB Interfaces
- Computer Peripherals
- Portable Equipment
- Test and Measurement
- M2M Communications
- Broadband Access

### Description

CTS Model 406 incorporates a high Q quartz resonator and is ideal for supporting a wide range of commercial and industrial applications.

### Ordering Information

Model	Temperature Range	Tolerance @ +25°C	Temperature Stability	Load Capacitance	Frequency [MHz]
406	C	3	5	D	XXMXXXXX
	Code   Temp. Range		Code   Stability		Code   Frequency
	C   $-20^{\circ}\text{C}$ to $+70^{\circ}\text{C}$		1   $\pm 10$ ppm <sup>1</sup>		Frequency <sup>2</sup>
	D   $-30^{\circ}\text{C}$ to $+85^{\circ}\text{C}$		X   $\pm 15$ ppm		
	I   $-40^{\circ}\text{C}$ to $+85^{\circ}\text{C}$		2   $\pm 20$ ppm		
			3   $\pm 30$ ppm		
			5   $\pm 50$ ppm		
	Code   Tolerance		Code   Capacitance	Code   Capacitance	Code   Capacitance
	1   $\pm 10$ ppm		K   8pF	B   13pF	F   24pF
	X   $\pm 15$ ppm		J   9pF	C   16pF	G   30pF
	2   $\pm 20$ ppm		A   10pF	D   18pF	H   32pF
	3   $\pm 30$ ppm		L   12pF	E   20pF	S   Series

Notes:

1] Check factory availability when combined with  $-40^{\circ}\text{C}$  to  $+85^{\circ}\text{C}$  temperature range.

2] Frequency is recorded with 2 leading digits before the "M" and 5 significant digits after the "M" [including zeroes].

(Ex. XXMXXXXX [16M38400], XXMXXXXX [22M11840], XXMXXXXX [14M31818])

**Not all performance combinations and frequencies may be available.  
Contact your local CTS Representative or CTS Customer Service for availability.**

This product is specified for use only in standard commercial applications. Supplier disclaims all express and implied warranties and liability in connection with any use of this product in any non-commercial applications or in any application that may expose the product to conditions that are outside of the tolerances provided in its specification.



## Electrical Specifications

### Operating Conditions

PARAMETER	SYMBOL	CONDITIONS	MIN	TYP	MAX	UNIT
Operating Temperature	T <sub>A</sub>	-	-20		+70	
			-30	+25	+85	°C
			-40		+85	
			-40		+105	
Storage Temperature	T <sub>STG</sub>	-	-55	-	+125	°C

### Frequency Stability

PARAMETER	SYMBOL	CONDITIONS	MIN	TYP	MAX	UNIT
Frequency Range	f <sub>0</sub>	Fundamental Mode		7 - 54		MHz
Frequency Tolerance	Δf/f <sub>0</sub>	@ +25°C		10, 15, 20, 25 or 30		±ppm
Frequency Stability	Δf/f <sub>25</sub>	Referenced to +25°C reading		10, 15, 20, 25, 30 or 50		±ppm
Aging	Δf/f <sub>0</sub>	Typical per year @ +25°C	-3	-	3	ppm

### Crystal Parameters

PARAMETER	SYMBOL	CONDITIONS	MIN	TYP	MAX	UNIT
Operating Mode	-	-		Fundamental		-
Crystal Cut	-	-		AT-Cut Strip		-
Load Capacitance	C <sub>L</sub>	-		See Ordering Information		pF
Shunt Capacitance	C <sub>0</sub>	-	-	5.0	7.0	pF
Series Resistance						
Fundamental	R <sub>1</sub>	7MHz - <12MHz	-	-	100	
		12MHz - <14MHz	-	-	60	Ω
		14MHz - <20MHz	-	-	50	
		20MHz - 54MHz	-	-	40	
Drive Level	DL	-	-	10	300	μW
Insulation Resistance	R <sub>i</sub>	+100Vdc ±15Vdc	500	-	-	MΩ

Δf/f<sub>0</sub> - Frequency deviation referenced to nominal frequency.

Δf/f<sub>25</sub> - Frequency deviation over operating temperature range, referenced to +25°C frequency.

## Mechanical Specifications

### Package Drawing

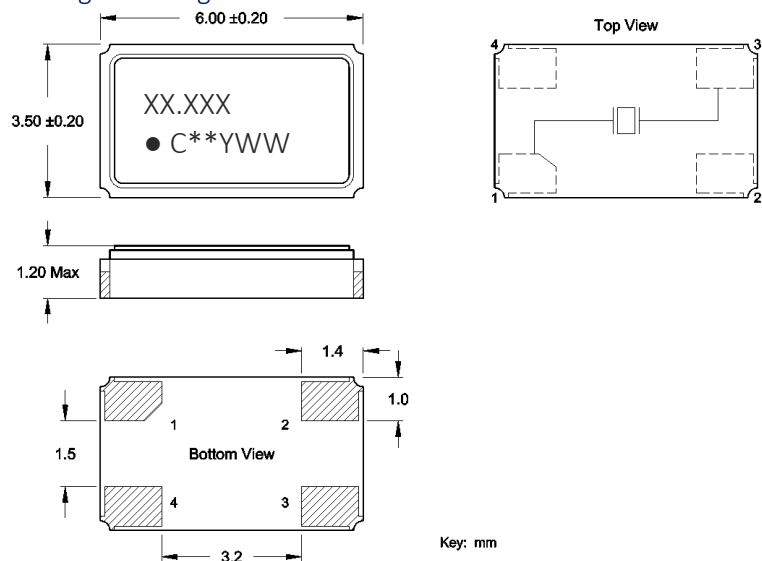

### Marking Information

1. XX.XXX – Frequency marked with 3 significant digits after the decimal.
2. C – CTS.
3. \*\* – Manufacturing Site code.
4. YWW – Date Code. Y = 1st Digit of Year, WW = Week.

### Recommended Pad Layout

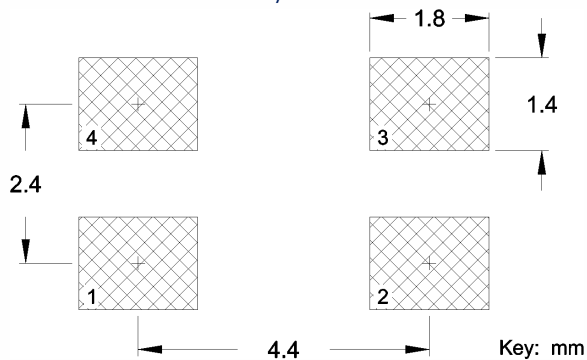

### Notes

1. JEDEC termination code (e4). Barrier-plating is nickel [Ni] with gold [Au] flash plate.
2. Terminations #2, #4 and the metal lid are connected internally. End user may connect these pins to circuit ground for EMI suppression.
3. Due to package variability, the pad chamfer on the bottom could be located on Pin 1 or 4 in a given lot. Layout orientation should be based on the top view [marking side], as indicated in package drawing. The chamfer location does not affect the electrical performance of the device.
4. Reflow conditions per JEDEC J-STD-020; +260°C maximum, 20 seconds.
5. MSL = 1.

### Packaging – Tape and Reel

#### Tape Drawing

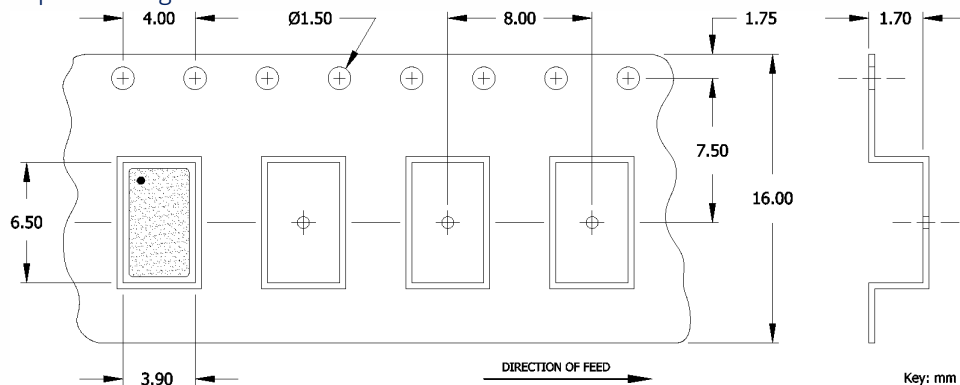

#### Reel Drawing

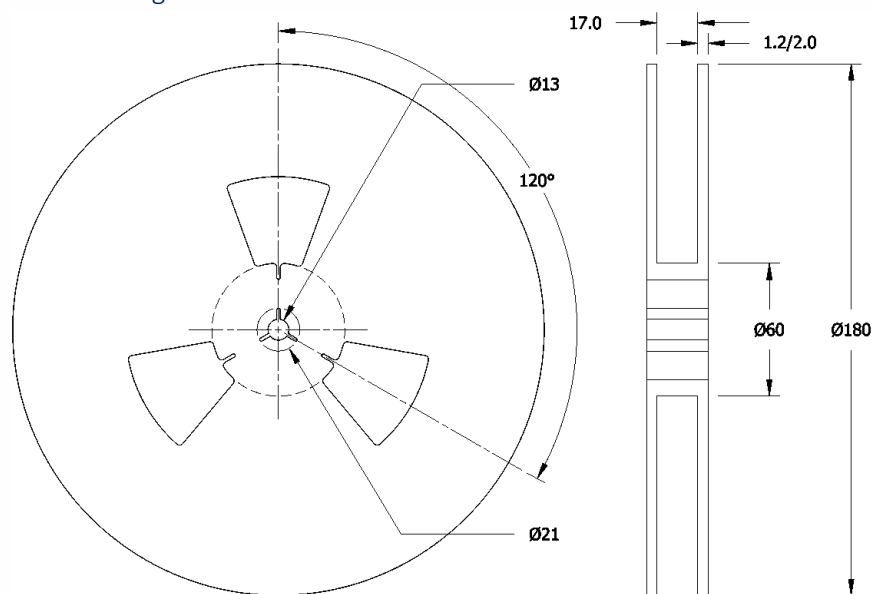

#### Notes

1. Device quantity is 1k pieces maximum per 180mm reel.
2. Complete CTS part number, frequency value, date code and manufacturing site code information must appear on reel and carton labels.





## Addendum

### Common Frequencies and Frequency Codes – MHz

Common Wireless Frequencies			Additional Frequencies					
FREQUENCY	PART NUMBER CODE	MARKING CODE	FREQUENCY	PART NUMBER CODE	MARKING CODE	FREQUENCY	PART NUMBER CODE	MARKING CODE
12.000000	12M00000	12.000	8.000000	08M00000	8.000	24.553500	24M553500	24.553
13.560000	13M56000	13.560	10.000000	10M00000	10.000	24.576000	24M576000	24.576
16.000000	16M00000	16.000	11.059200	11M05920	11.059	25.000625	25M00062	25.001
19.200000	19M20000	19.200	12.288000	12M28800	12.288	26.041660	26M04166	26.041
20.000000	20M00000	20.000	12.500000	12M50000	12.500	26.800000	26M800000	26.800
24.000000	24M00000	24.000	12.688000	12M68800	12.688	27.000000	27M000000	27.000
25.000000	25M00000	25.000	12.800000	12M80000	12.800	27.600000	27M600000	27.600
26.000000	26M00000	26.000	13.000000	13M00000	13.000	28.224000	28M224000	28.224
27.120000	27M12000	27.120	13.500000	13M50000	13.500	28.322000	28M322000	28.322
30.000000	30M00000	30.000	13.553750	13M55375	13.553	28.375000	28M375000	28.375
32.000000	32M00000	32.000	13.824000	13M82400	13.824	28.636360	28M63636	28.636
37.400000	37M40000	37.400	13.934400	13M93440	13.934	29.491200	29M491200	29.491
38.400000	38M40000	38.400	14.000000	14M00000	14.000	30.400000	30M400000	30.400
40.000000	40M00000	40.000	14.318180	14M31818	14.318	30.720000	30M720000	30.720
48.000000	48M00000	48.000	14.400000	14M40000	14.400	31.250000	31M250000	31.250
52.000000	52M00000	52.000	14.745600	14M74560	14.745	32.768000	32M768000	32.768
			15.360000	15M36000	15.360	33.000000	33M000000	33.000
			16.367600	16M36760	16.367	33.330000	33M330000	33.330
			16.368000	16M36800	16.368	33.333000	33M333000	33.333
			16.384000	16M38400	16.384	33.333300	33M333300	33.334
			16.666700	16M66670	16.666	33.868800	33M868800	33.868
			16.800000	16M80000	16.800	35.328000	35M328000	35.328
			16.934400	16M93440	16.934	36.000000	36M000000	36.000
			18.000000	18M00000	18.000	37.500000	37M500000	37.500
			18.432000	18M43200	18.432	38.000000	38M000000	38.000
			19.440000	19M44000	19.440	38.880000	38M880000	38.880
			19.660800	19M66080	19.660	39.062500	39M062500	39.062
			19.680000	19M68000	19.680	41.600000	41M600000	41.600
			20.480000	20M48000	20.480	44.000000	44M000000	44.000
			20.736000	20M73600	20.736	45.000000	45M000000	45.000
			22.118400	22M11840	22.118	49.152000	49M152000	49.152
			22.579200	22M57920	22.579	50.000000	50M000000	50.000
			24.305000	24M30500	24.305	54.000000	54M000000	54.000
			24.545400	24M54540	24.545			
			24.545454	24M54545	24.546			

## Looking for pricing, stock, or lifecycle information?

Click below to explore more details on WIN SOURCE:

-  [View 406C35D16M00000 on WIN SOURCE](#)
-  [CTS-Frequency Controls Information](#)

## Optimize Your Supply Chain with WIN SOURCE Solutions

-  Global Sourcing Solution
-  Obsolete Management
-  Cost Control Management
-  Shortage Management
-  Alternative Solution
-  Excess Inventory Management