



**THE DATASHEET OF
ABM10W-16.0000MHZ-6-D1X-T3**



LOW ESR, LOW CL CERAMIC SMD CRYSTAL

ABM10W Series

Request Samples



Check Inventory



2.5 x 2.0 x 0.6 mm
RoHS/RoHS II Compliant
MSL Level = N/A



Features

- Optimized for energy saving wearables and IoT applications
- Plated at exceptionally low plating capacitance, as low as 4pF, with optimized ESR
- 0.6 mm max height ideally suited for height constrained designs
- Seam sealed for longterm reliability

Key Electrical Specifications

Applications

- Wearables
- Internet of Things (IoT)
- Bluetooth/Bluetooth Low Energy (BLE)
- Wireless modules
- Machine-to-machine (M2M) connectivity
- Ultra-low power MCU
- Near Field Communication (NFC)
- ISM Band

Parameters	Minimum	Typical	Maximum	Units	Notes
Frequency Range	16.000		50.0000	MHz	
Operation Mode	Fundamental				
Operating Temperature Range	-40		+125	°C	<i>See options</i>
Storage Temperature	-55		+125	°C	
Frequency Tolerance @ +25°C	-10		+10	ppm	<i>See options</i>
Frequency Stability over the Operating Temperature (ref. to +25°C)	-10		+10	ppm	<i>See options</i>
Equivalent series resistance "R1" (over Operating Temperature Range) (CL=4pF)		< 70	100	Ω	16.0000 – 19.9999MHz
		< 50	80		20.0000 – 29.9999MHz
		< 40	60		30.0000 – 39.9999MHz
		< 25	40		40.0000 – 50.0000MHz
Equivalent series resistance "R1" (over Operating Temperature Range) (CL=6pF, 7pF, 8pF)		< 50	70	Ω	16.0000 – 19.9999MHz
		< 35	50		20.0000 – 29.9999MHz
		< 30	40		30.0000 – 39.9999MHz
		< 25	30		40.0000 – 50.0000MHz
Shunt capacitance (C0)		< 1.0	2.0	pF	
Load capacitance (CL)		4.0		pF	<i>See options</i>
Drive Level		10	100	μW	
Aging (1 year)	-2		+2	ppm	@25°C±3°C
Insulation Resistance	500			MΩ	@ 100Vdc ± 15V

LOW ESR, LOW CL CERAMIC SMD CRYSTAL

ABM10W Series

Request Samples



Check Inventory



2.5 x 2.0 x 0.6 mm
RoHS/RoHS II Compliant
MSL Level = N/A



Options and Part Identification [Note 1]

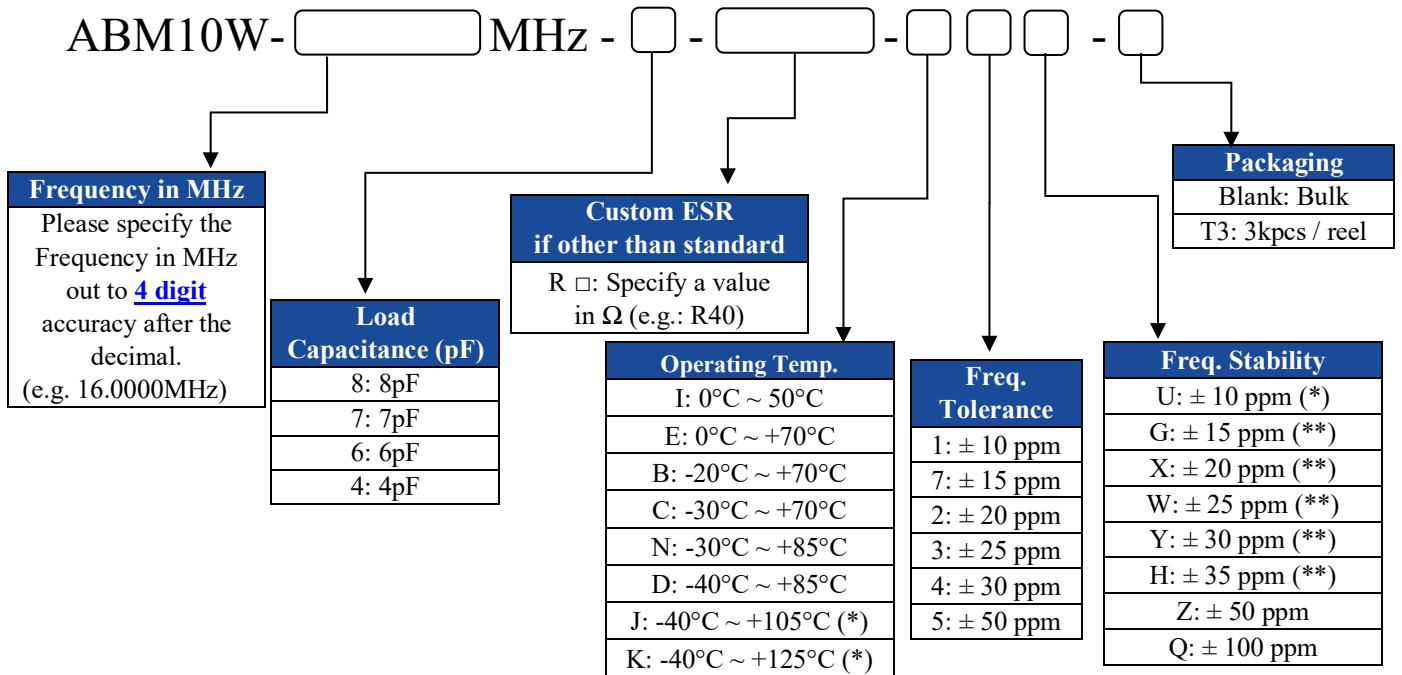

(*) Only offered @
Freq. Stability
options: Z & Q.

Contact ABRACON
for tighter
Frequency Stability.

(*) Only offered @
Operating Temp.
Range options: I, E, & B
(**) Only offered @
Operating Temp.
Range options: I, E, B,
C, N, & D

Contact ABRACON
for wider Operating
Temp. Range.

Note 1:

Contact Abracon for part number requests

With carrier frequency callouts up to 5 & 6 digit accuracy after the decimal.



5101 Hidden Creek Ln Spicewood TX 78669
Phone: 512-371-6159 | Fax: 512-351-8858
For terms and conditions of sales, please visit:
www.abracon.com

REVISED: 02-23-24

ABRACON IS
ISO9001-2015
CERTIFIED

LOW ESR, LOW CL CERAMIC SMD CRYSTAL

ABM10W Series

Request Samples



Check Inventory



2.5 x 2.0 x 0.6 mm
RoHS/RoHS II Compliant
MSL Level = N/A



Mechanical Dimensions

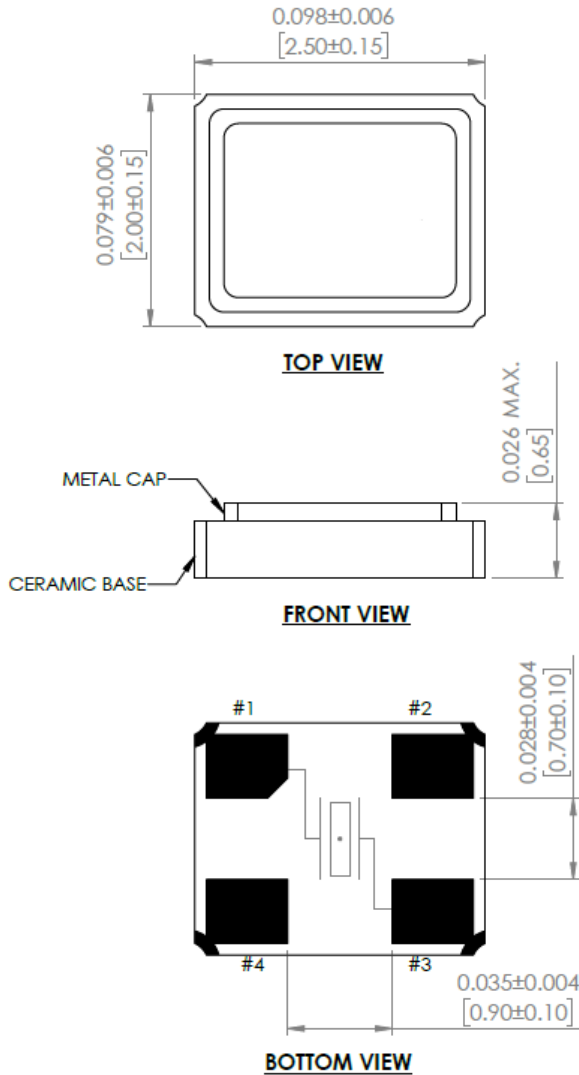

Recommended Land Pattern

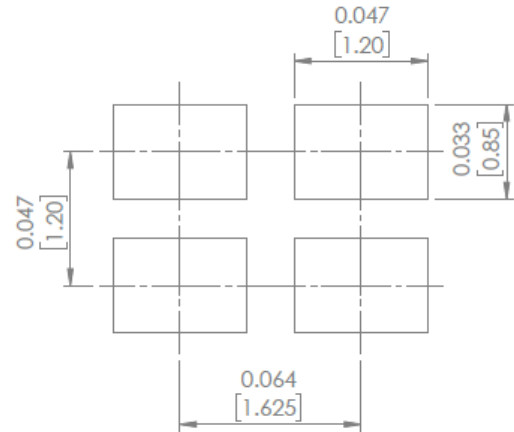

Pin#2: GND
Pin#4: GND

Note:

Due to material availability the Chamfer could be located on pin #1, 2 or 4. Be advised that the Chamfer location has no impact on the electrical performance of the device.

Dimensions: inches [mm]

LOW ESR, LOW CL CERAMIC SMD CRYSTAL

ABM10W Series

Request Samples



Check Inventory



2.5 x 2.0 x 0.6 mm
RoHS/RoHS II Compliant
 MSL Level = N/A



Typical Frequency vs. Temperature Characteristics:

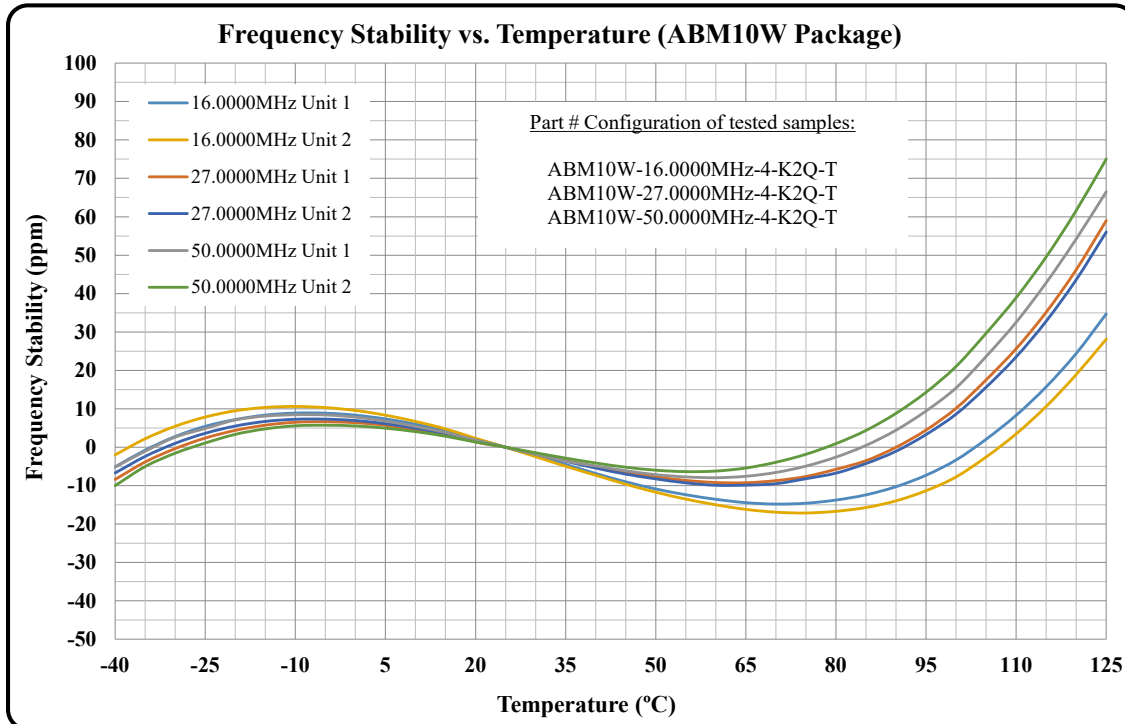
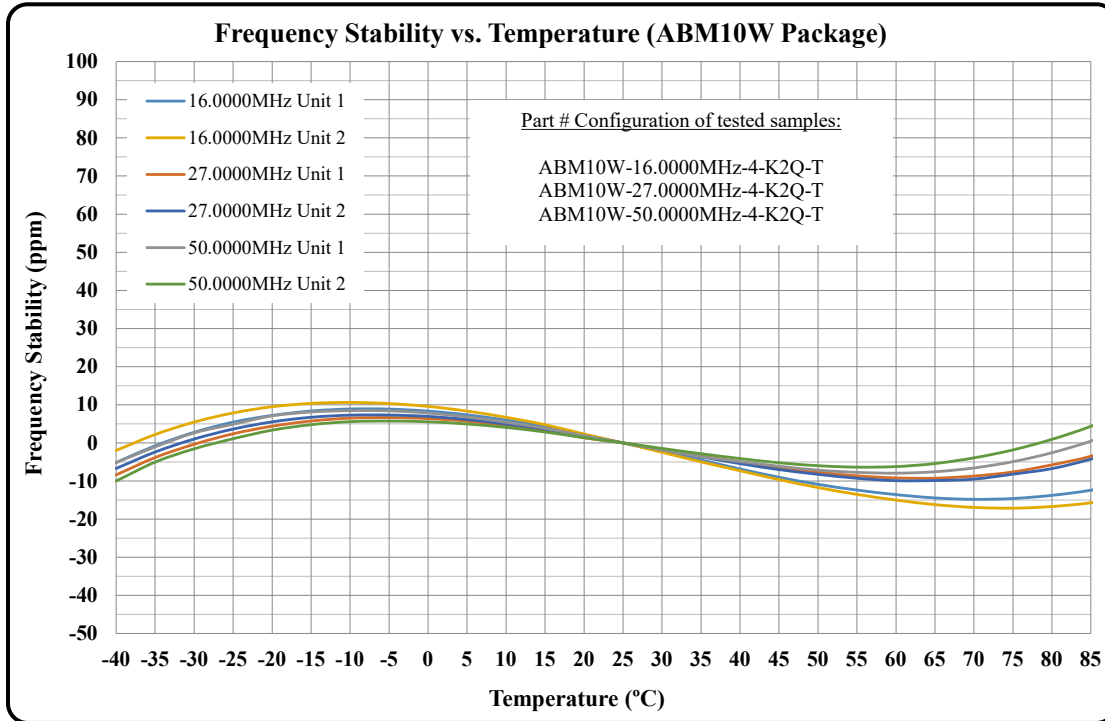

LOW ESR, LOW CL CERAMIC SMD CRYSTAL

ABM10W Series

Request Samples



Check Inventory



2.5 x 2.0 x 0.6 mm
 RoHS/RoHS II Compliant
 MSL Level = N/A



Typical ESR (Equivalent Series Resistance) vs. Temperature Characteristics:

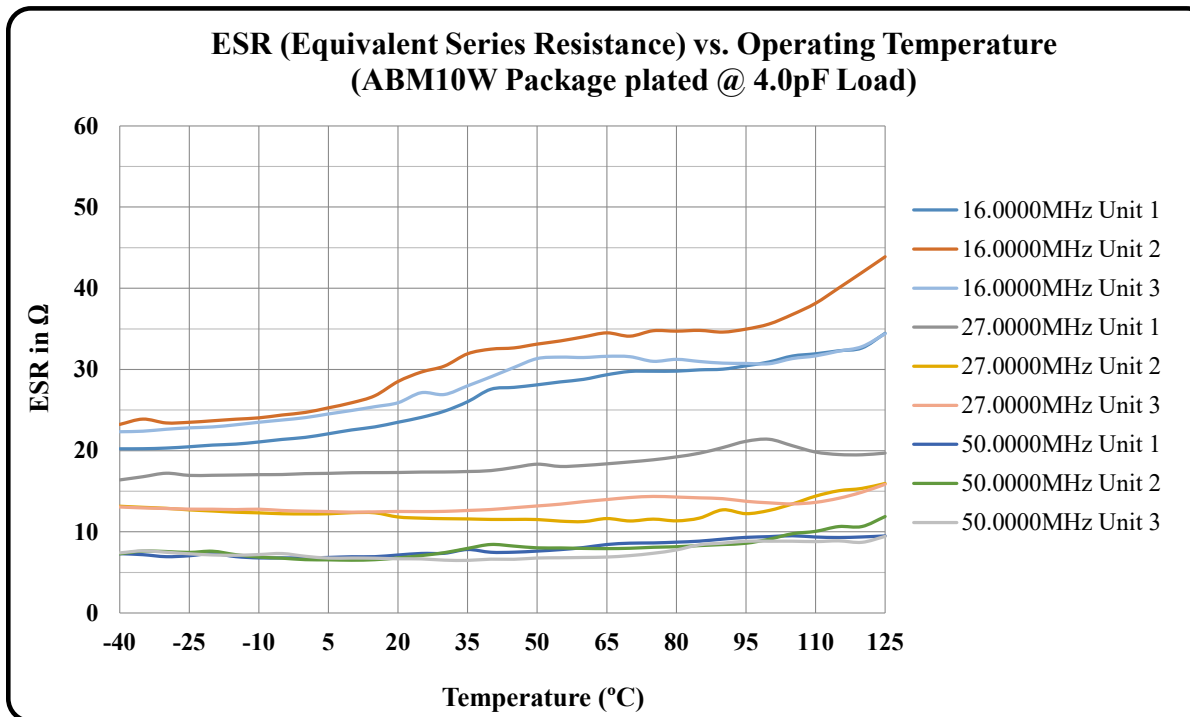
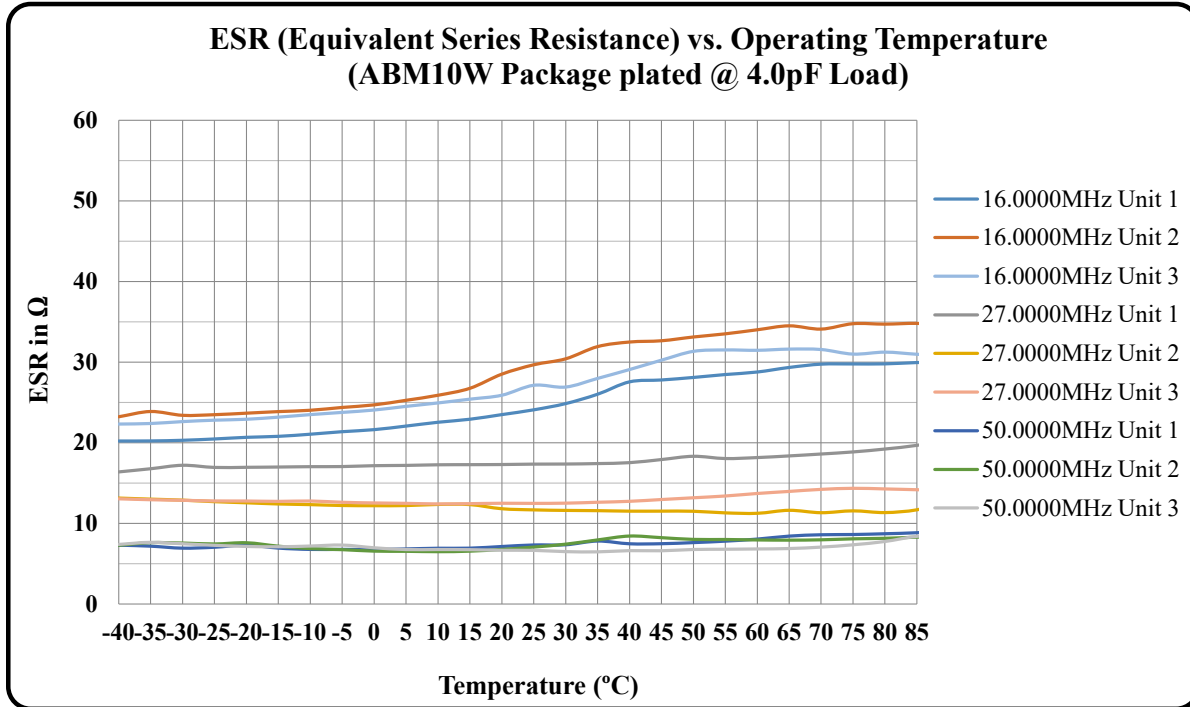

*Plating Load = Load Capacitance (CL)



5101 Hidden Creek Ln Spicewood TX 78669
 Phone: 512-371-6159 | Fax: 512-351-8858
 For terms and conditions of sales, please visit:
www.abracon.com

REVISED: 02-23-24

ABRACON IS
 ISO9001-2015
 CERTIFIED

LOW ESR, LOW CL CERAMIC SMD CRYSTAL

ABM10W Series

Request Samples



Check Inventory



2.5 x 2.0 x 0.6 mm
RoHS/RoHS II Compliant
MSL Level = N/A



SPICE Models (based on typical values at 25°C ± 3°C):

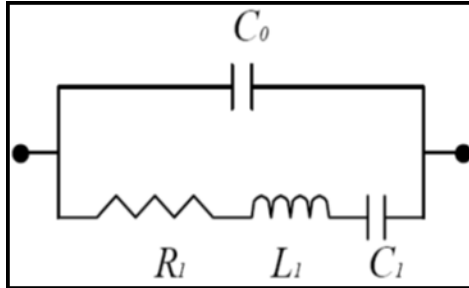

Frequency: 16.0000MHz Plating Load: 4pF				Frequency: 16.0000MHz Plating Load: 6pF			
C0	=	0.65	pF	C0	=	0.65	pF
R1	=	22.77	Ω	R1	=	21.43	Ω
L1	=	70.34	mH	L1	=	70.13	mH
C1	=	1.41	fF	C1	=	1.41	fF
Frequency: 27.0000MHz Plating Load: 4pF				Frequency: 27.0000MHz Plating Load: 6pF			
C0	=	0.65	pF	C0	=	0.66	pF
R1	=	14.39	Ω	R1	=	17.38	Ω
L1	=	16.51	mH	L1	=	16.56	mH
C1	=	2.11	fF	C1	=	2.10	fF
Frequency: 50.0000MHz Plating Load: 4pF				Frequency: 50.0000MHz Plating Load: 6pF			
C0	=	0.89	pF	C0	=	0.87	pF
R1	=	8.40	Ω	R1	=	8.03	Ω
L1	=	3.24	mH	L1	=	3.19	mH
C1	=	3.13	fF	C1	=	3.18	fF

Typical Frequency Tolerance Distribution (at 25°C ± 3°C)

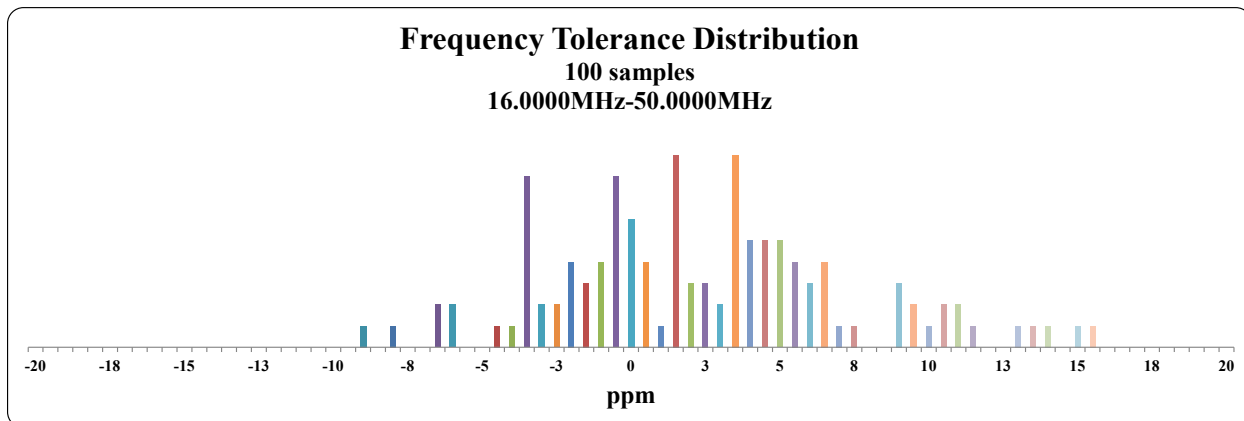

LOW ESR, LOW CL CERAMIC SMD CRYSTAL

ABM10W Series

Request Samples



Check Inventory



2.5 x 2.0 x 0.6 mm
RoHS/RoHS II Compliant
MSL Level = N/A



Typical ESR Distribution (at 25°C ± 3°C):

ESR Distribution @ 16.0000MHz

100 samples

MAX ESR = 29.46 Ω

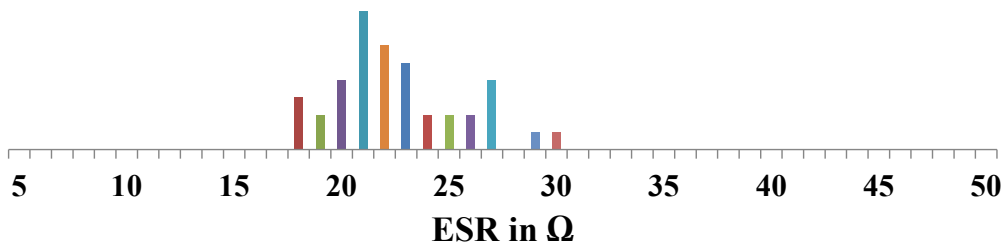

ESR Distribution @ 27.0000MHz

100 samples

MAX ESR = 21.10 Ω

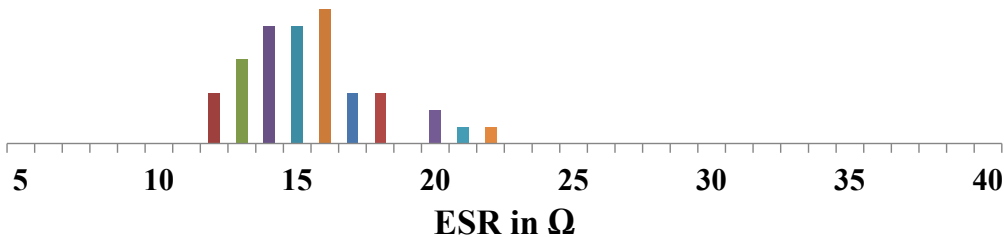

ESR Distribution @ 50.0000MHz

100 samples

MAX ESR = 12.60 Ω

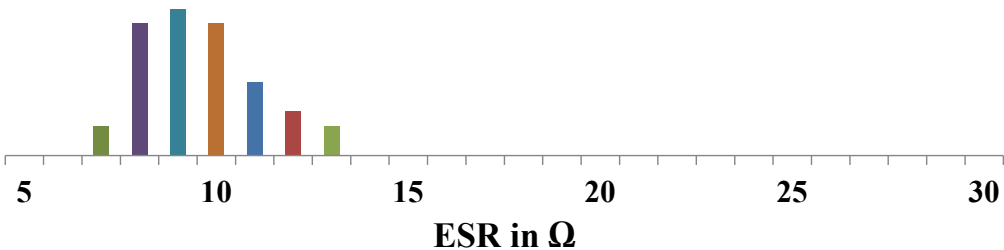

LOW ESR, LOW CL CERAMIC SMD CRYSTAL

ABM10W Series

Request Samples



Check Inventory



2.5 x 2.0 x 0.6 mm
RoHS/RoHS II Compliant
MSL Level = N/A



Reflow Profile [JEDEC J-STD-020]

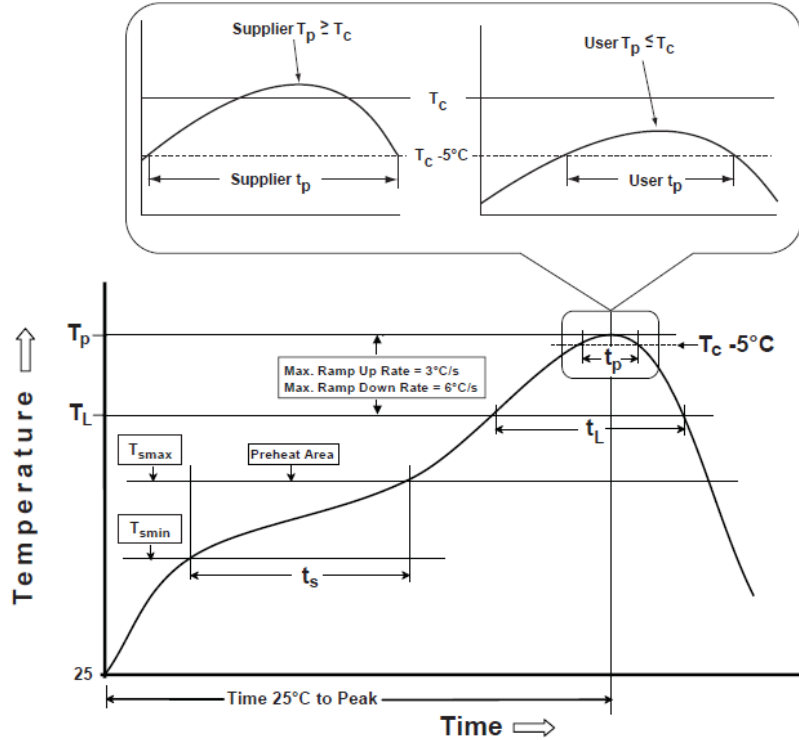

Table 1

SnPb Eutectic Process
Classification Temperatures (T_c)

Package Thickness	Volume mm ³ <350	Volume mm ³ ≥350
<2.5 mm	235 °C	220 °C
≥2.5 mm	220 °C	220 °C

Table 2

Pb-Free Process
Classification Temperatures (T_c)

Package Thickness	Volume mm ³ <350	Volume mm ³ 350-2000	Volume mm ³ >2000
<1.6 mm	260 °C	260 °C	260 °C
1.6 mm - 2.5 mm	260 °C	250 °C	245 °C
>2.5 mm	250 °C	245 °C	245 °C

Profile Feature	Sn-Pb Eutectic Assembly	Pb-Free Assembly
Preheat / soak		
Temperature minimum (T_{smin})	100°C	150°C
Temperature maximum (T_{smax})	150°C	200°C
Time (T_{smin} to T_{smax}) (t_s)	60 - 120 sec.	60 - 120 sec.
Average ramp-up rate (T_{smax} to T_p)	3°C/sec. max	3°C/sec. max
Liquidous temperature (T_L)	183°C	217°C
Time at liquidous (t_L)	60 - 150 sec.	60 - 150 sec.
Peak package body temperature (T_p)*	see Table 1	see Table 2
Time (t_p)** within 5°C of the specified classification temperature (T_c)	20 sec.	30 sec.
Ramp-down rate (T_p to T_{smax})	6°C/sec. max	6°C/sec. max
Time 25°C to peak temperature	6 min. max	8 min. max
Reflow cycles	2 max	2 max

*Tolerance for peak profile temperature (T_p) is defined as a supplier minimum and a user maximum.

**Tolerance for time at peak profile temperature (t_p) is defined as supplier minimum and a user maximum.



5101 Hidden Creek Ln Spicewood TX 78669
Phone: 512-371-6159 | Fax: 512-351-8858
For terms and conditions of sales, please visit:
www.abracon.com

REVISED: 02-23-24

ABRACON IS
ISO9001-2015
CERTIFIED

LOW ESR, LOW CL CERAMIC SMD CRYSTAL

ABM10W Series

Request Samples



Check Inventory



2.5 x 2.0 x 0.6 mm
RoHS/RoHS II Compliant
MSL Level = N/A



Packaging

T3: Tape and reel (3,000pcs/reel)

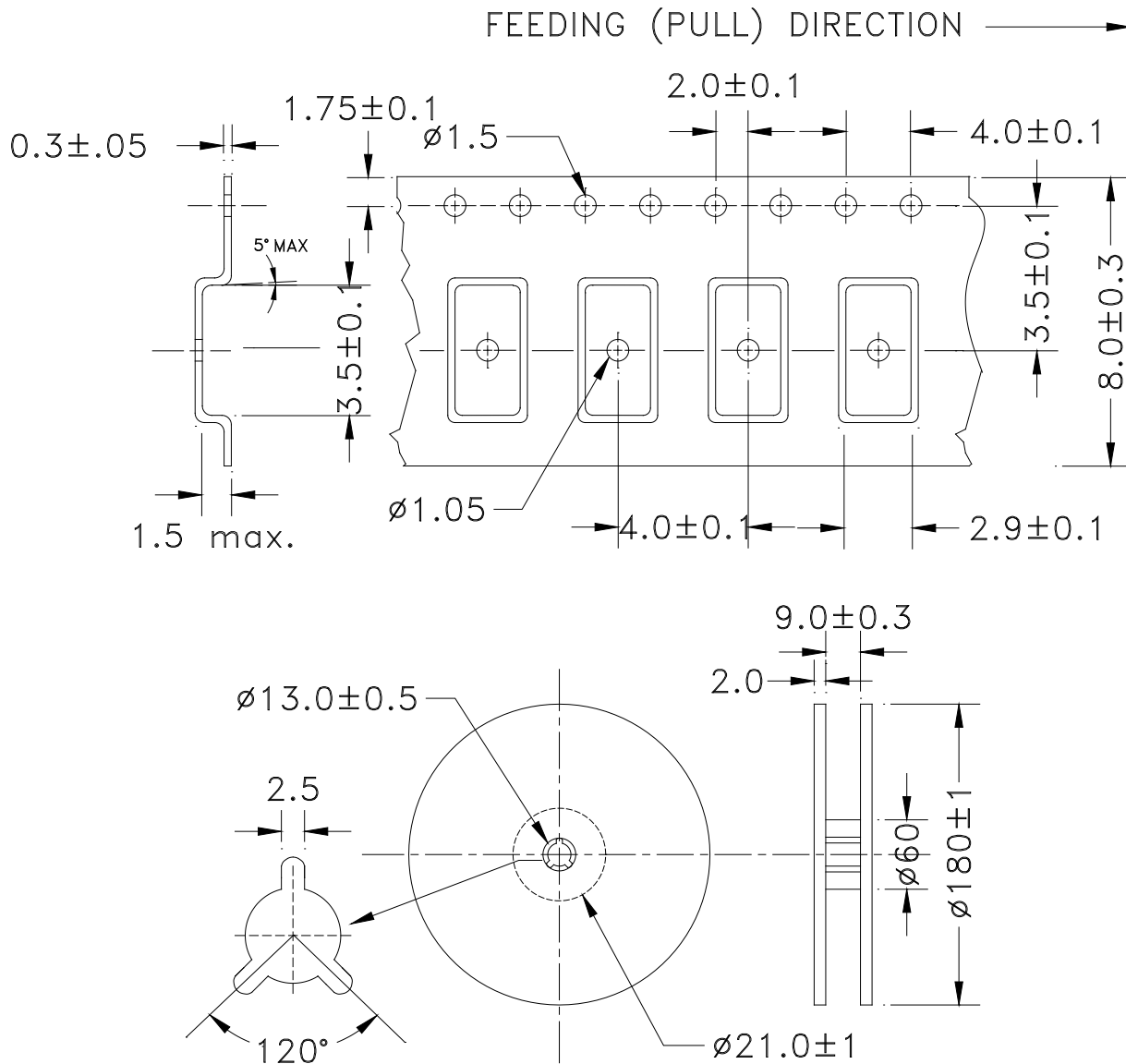

Dimensions: mm

ATTENTION: Abracon LLC's products are COTS – Commercial-Off-The-Shelf products; suitable for Commercial, Industrial and, where designated, Automotive Applications. Abracon's products are not specifically designed for Military, Aviation, Aerospace, Life-dependent Medical applications or any application requiring high reliability where component failure could result in loss of life and/or property. For applications requiring high reliability and/or presenting an extreme operating environment, written consent and authorization from Abracon LLC is required. Please contact Abracon LLC for more information.



5101 Hidden Creek Ln Spicewood TX 78669
Phone: 512-371-6159 | Fax: 512-351-8858
For terms and conditions of sales, please visit:
www.abracon.com

REVISED: 02-23-24

ABRACON IS
ISO9001-2015
CERTIFIED

Looking for pricing, stock, or lifecycle information?

Click below to explore more details on WIN SOURCE:

 [View ABM10W-16.0000MHZ-6-D1X-T3 on WIN SOURCE](#)

 [Abracon LLC Information](#)

Optimize Your Supply Chain with WIN SOURCE Solutions

-  Global Sourcing Solution
-  Obsolete Management
-  Cost Control Management
-  Shortage Management
-  Alternative Solution
-  Excess Inventory Management