



**THE DATASHEET OF
VY2222M35Y5US63V0**



EMI Suppression Safety Capacitor, Ceramic Disc, Class X1, 440 V_{AC}, Class Y2, 300 V_{AC}



LINKS TO ADDITIONAL RESOURCES



QUICK REFERENCE DATA				
DESCRIPTION	VALUE			
Ceramic Class	1	2		
Ceramic Dielectric	U2J	Y5S, Y5U, Y5V		
Voltage (V _{AC})	300	440	300	440
Min. Capacitance (pF)	10		68	
Max. Capacitance (pF)	47		10 000	
Mounting	Radial			

OPERATING TEMPERATURE RANGE

-40 °C to +125 °C

TEMPERATURE CHARACTERISTICS

Class 1: U2J

Class 2: Y5S, Y5U, Y5V

SECTIONAL SPECIFICATIONS

Climatic category (according to EN 60058-1)

Class 1 and class 2: 40 / 125 / 21

COATING

According to UL 94 V-0

Epoxy resin, isolating, flame retardant

APPROVALS

IEC 60384-14

UL 60384-14

DIN EN 60384-14

CSA E60384-1:03, CSA E60384-14:09

CQC11-471112

PACKAGING

Bulk, tape and reel, taped ammpack

FEATURES

- Complying with IEC 60384-14
- High reliability
- Vertical (inline) kinked or straight leads
- Singlelayer AC disc safety capacitors
- Material categorization:
for definitions of compliance please see www.vishay.com/doc?99912



RoHS
COMPLIANT
HALOGEN
FREE
GREEN
(5-2008)

APPLICATIONS

- X1, Y2 according to IEC 60384-14
- Line-to-line filtering (Class X)
- Line-to-ground filtering (Class Y)
- Primary and secondary coupling (SMPS)
- EMI / RFI suppression and filtering

DESIGN

The capacitor consists of a ceramic disc which is silver plated on both sides. Connection leads are made of tin plated copper-clad steel having a diameter of 0.6 mm.

The capacitors may be supplied with vertical (inline) kinked leads having a lead spacing of 5.0 mm, 7.5 mm, 10.0 mm, or 12.5 mm. Encapsulation is made of flame retardant epoxy resin in accordance with UL 94 V-0.

CAPACITANCE RANGE

10 pF to 0.01 μF

RATED VOLTAGE U_R

IEC 60384-14:

(X1): 440 V_{AC}, 50 Hz

(Y2): 300 V_{AC}, 50 Hz

1000 V_{DC}

TEST VOLTAGE

Component test (100 %):

2600 V_{AC}, 50 Hz, 2 s

(2600 V_{AC} for LS 7.5 mm and above)

(2200 V_{AC} for LS 5.0 mm)

Random sampling test (destructive test):

2600 V_{AC}, 50 Hz, 60 s

Voltage proof of coating (destructive test):

2600 V_{AC}, 50 Hz, 60 s

INSULATION RESISTANCE

≥ 10 000 MΩ

CAPACITANCE TOLERANCE

± 20 % (code M); ± 10 % (code K)

DISSIPATION FACTOR

Class 1: max. 0.5 % (1 MHz)

Class 2: max. 2.5 % (1 kHz)

DIMENSIONS in millimeters

 Capacitors with 5.0 mm, 7.5 mm, 10 mm, or 12.5 mm lead spacing.
 Coating extension e valid for straight leads only.

TECHNICAL DATA

CAPACITANCE C (pF)	CAPACITANCE TOLERANCE (%)	BODY DIAMETER D _{max.} (mm)	BODY THICKNESS T _{max.} (mm)	LEAD SPACING ⁽¹⁾ F (mm) ± 1 mm	PART NUMBER	
					MISSING DIGITS SEE ORDERING CODE BELOW	
U2J						
10	± 10	7.5	5.0	5.0, 7.5, 10.0, or 12.5	VY2100K29U2JS6###	
15					VY2150K29U2JS6###	
22					VY2220K29U2JS6###	
33					VY2330K29U2JS6###	
47					VY2470K29U2JS6###	
Y5S						
68	± 10	7.5	5.0	5.0, 7.5, 10.0, or 12.5	VY2680K29Y5SS6###	
100					VY2101K29Y5SS6###	
150					VY2151K29Y5SS6###	
220					VY2221K29Y5SS6###	
330					VY2331K29Y5SS6###	
470					VY2471K29Y5SS6###	
Y5U						
680	± 20	7.5	5.0	5.0, 7.5, 10.0, or 12.5	VY2681M29Y5US6###	
1000						VY2102M29Y5US6###
1500		8.0				VY2152M31Y5US6###
2200		9.0				VY2222M35Y5US6###
3300		10.5				VY2332M41Y5US6###
3900		11.0				VY2392M43Y5US6###
4700		12.5				VY2472M49Y5US6###
6800		14.5				7.5, 10.0, or 12.5
10 000		16.0				VY2103M63Y5US63##
Y5V						
1000	± 20	7.5	5.0	5.0, 7.5, 10.0, or 12.5	VY2102M29Y5VS6###	
1500		7.5				VY2152M29Y5VS6###
2200		8.0				VY2222M31Y5VS6###
3300		9.0				VY2332M35Y5VS6###
3900		10.0				VY2392M39Y5VS6###
4700		10.5				VY2472M41Y5VS6###
6800		12.0				VY2682M47Y5VS6###
10 000		15.0				VY2103M59Y5VS6###

Note
⁽¹⁾ Straight leads are available on request



ORDERING CODE										
###	15 th to 17 th digit		Lead configuration			Available configurations see below				
Example	VY2	221	K	29	Y5S	S	6	U	V	7
	Series	Capacitance value	Tolerance code	Size code	Temperature coefficient	Rated voltage	Lead wire diameter	Packaging / lead length	Lead style	Lead spacing
						S = X1/Y2 300 V (AC)		3 = bulk T = tape and reel U = ammpack	L = straight V = inline kinked	5 = 5.0 7 = 7.5 0 = 10.0 X = 12.5

PACKAGING						
LEAD SPACING (mm)	CAPACITANCE VALUE	BODY DIAMETER D _{max.} (mm)	PACKAGING QUANTITIES			TAPING FIGURE
			BULK	REEL	AMMO	
5.0	10 pF to 4700 pF	11.0	1000	1000	1000	Fig. 1
7.5	10 pF to 6800 pF	14.0	1000	1000	1000	Fig. 1
	6800 pF to 10 000 pF	16.0	500	500	500	Fig. 2
10.0 / 12.5	10 pF to 6800 pF	14.0	1000	500	750	Fig. 2
	6800 pF to 10 000 pF	16.0	500	500	750	Fig. 2

Note

- The capacitors are supplied in bulk packaging (cardboard boxes), in tape on reel, or in ammpack

STRAIGHT LEADS

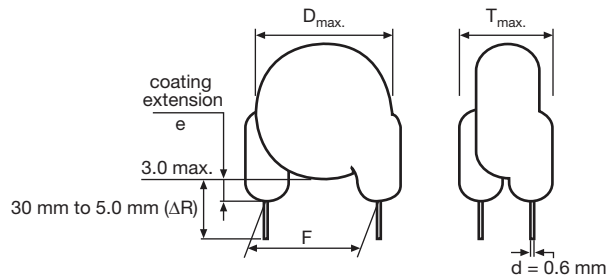



Fig. 1 - The hole pitch 12.7 mm for lead spacing 5 mm (0.2") and 15.0 mm for lead spacing 7.5 mm (0.3")



Fig. 2 - The hole pitch 12.7 mm for lead spacing 10.0 mm (0.40") and 12.5 mm (0.50")

DIMENSION OF TAPE		DIMENSIONS (mm)		
SYMBOL	PARAMETER	FIG. 1 (5 mm)	FIG. 1 (7.5 mm)	FIG. 2 (10 mm)
D ⁽¹⁾	Body diameter	11.0 max.	14.0 max.	16.0 max.
d	Lead diameter	0.6 ± 0.05	0.6 ± 0.05	0.6 ± 0.05
P	Pitch of component	12.7 ± 1	15.0 ± 1	25.4 ± 1
P ₀ ⁽²⁾	Pitch of sprocket hole	12.7 ± 0.3	15.0 ± 0.3	12.7 ± 0.3
P ₁ ⁽³⁾	Distance, hole center to lead	3.85 ± 0.7	3.75 ± 0.7	7.7 ± 1.0
P ₂ ⁽³⁾	Distance, hole to center of component	6.35 ± 1.3	7.5 ± 1.5	12.7 ± 1.5
F	Lead spacing	5.0 (+ 0.6 / - 0.4)	7.5 (+ 0.6 / - 0.4)	10.0 (+ 0.6 / - 0.4)
Δh	Average deviation across tape	± 1.0 max.	± 1.0 max.	± 1.0 max.
ΔP	Average deviation in direction of reeling	± 1.0 max.	± 1.0 max.	± 1.0 max.
W	Carrier tape width	18.0 + 1 / - 0.5	18.0 + 1 / - 0.5	18.0 + 1 / - 0.5
W ₀	Hold-down tape width	5.0 min.	5.0 min.	5.0 min.
W ₁	Position of sprocket hole	9.0 + 0.75 / - 0.5	9.0 + 0.75 / - 0.5	9.0 + 0.75 / - 0.5
W ₂	Distance of hold-down tape	3.0 max.	3.0 max.	3.0 max.
H ₁	Maximum component height	32	40	40
H ₀	Height to seating plane (for kinked leads)	16.0 ± 0.5	16.0 ± 0.5	16.0 ± 0.5
H ₀	Height to seating plane (for straight leads)	20.0 ± 0.5	20.0 ± 0.5	20.0 ± 0.5
L	Length of cut leads	11.0 max.	11.0 max.	11.0 max.
L ₁	Length of lead protrusion	1.0 max.	1.0 max.	1.0 max.
D ₀	Diameter of sprocket hole	4.0 ± 0.2	4.0 ± 0.2	4.0 ± 0.2
t	Total tape thickness	0.9 max.	0.9 max.	0.9 max.
t ₁	Maximum thickness of tape and wires	1.5 max.	1.5 max.	1.5 max.

Notes



- (1) See "Technical Data" table
- (2) Cumulative pitch error: ± 1 mm/20 pitches
- (3) Obliquity maximum 3°

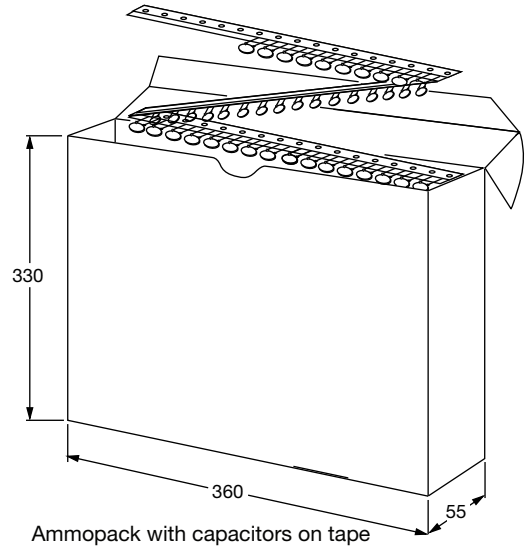
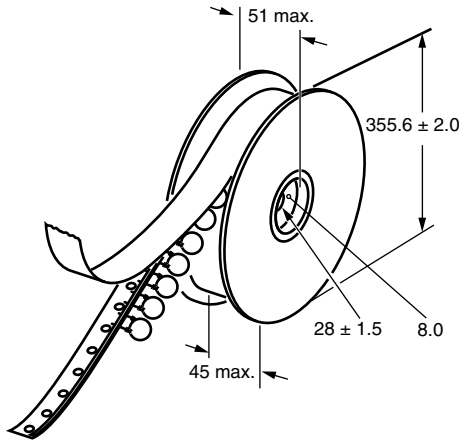

REEL AND TAPE DATA in millimeters

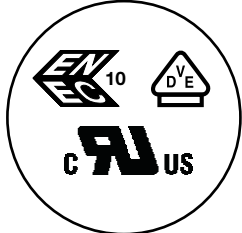

APPROVALS				
IEC 60384-14 - Safety tests This approval together with CB test certificate substitutes all national approvals.				
CB Certificate				
Y2-capacitor: CB test certificate:	US-26163-UL	10 pF to 10 nF	300 V _{AC}	
X1-capacitor: CB test certificate:	US-26163-UL	10 pF to 10 nF	440 V _{AC}	
VDE				
Y2-capacitor: VDE marks approval:	40009669	10 pF to 10 nF	300 V _{AC}	
X1-capacitor: VDE marks approval:	40009669	10 pF to 10 nF	440 V _{AC}	
DIN EN 60384-14 VDE 0565-1-1:2006-04 - Safety tests				
Underwriters Laboratories Inc. / Canadian Standards Association				
Y2-capacitor: UL-test certificate:	E183844	10 pF to 10 nF	300 V _{AC}	
X1-capacitor: UL-test certificate:	E183844	10 pF to 10 nF	440 V _{AC}	
UL 60384-14.1, CSA E60384-1:03 2 nd edition, CSA E60384-14:09 2 nd edition Across-the-line, antenna-coupling, and line-by-pass component				
CQC				
Y2-capacitor: CQC test certificate:	CQC05001012316	10 pF to 10 nF	300 V _{AC}	
X1-capacitor: CQC test certificate:	CQC05001012316	10 pF to 10 nF	440 V _{AC}	

MARKING		
Sample (2 sides)  Front	 Back	 PN: VY2331K29Y5SS6UV7 Lot1: 14Z549306 DC1: 0601 QTY: 1000 Lot2: DC2: PO: Batch: 200601CN SO: Region: 9520 SL: 0010 Ser.No: 0601H72383 
4 digit date code (year/week; add suffix "V" for Y5V)		2/5

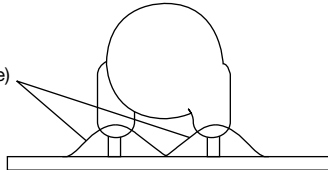
PERFORMANCE		
TEST	TEST CONDITION	TEST LIMITS
Visual and mechanical inspection	Optical inspection, dimensions measured with caliper	No visible damage, marking legible
Capacitance (C)	25 °C ± 3 °C, relative humidity (RH) ≤ 75 %, 1.0 V _{RMS} ± 0.2 V _{RMS} at 1 kHz for Y5U and Y5S, and 1 MHz for U2J	Capacitance within specified tolerance
Dissipation factor (DF)		DF ≤ 0.3 % for U2J and DF ≤ 2.5 % for Y5S and Y5U
Insulation resistance (IR)	Measured within 60 s ± 5 s after charging at 500 V _{DC}	10 000 MΩ min.
Dielectric strength	2600 V _{AC} at 50 Hz / 60 Hz for 1 min, 50 mA max.	No failure
Temperature characteristic	RH ≤ 75 %, 1.0 V _{RMS} ± 0.2 V _{RMS} at 1 kHz for Y5U and Y5S, and 1 MHz for U2J	U2J: -750 ppm ± 120 ppm Y5S: ± 22 % Y5U: +22 % / -56 %
Impulse voltage	3 pulses of 5 kV	No failure
Life test	1000 h at 125 °C ± 2 °C, 550 V _{AC} /50 Hz; once every hour 1000 V _{AC} for 0.1 s	External appearance: no visible damage ΔC/C ≤ ± 15 % DF ≤ 0.5 % for U2J and ≤ 5 % for Y5S and Y5U IR ≥ 3000 MΩ Dielectric strength: no failure
Humidity test	500 h at 440 V _{AC} , 50 Hz and 500 h unloaded 40 °C, RH = 90 % to 95 %	External appearance: no visible damage ΔC/C ≤ ± 10 % for U2J and ≤ ± 15 % for Y5S and Y5U DF ≤ 0.5 % for U2J and ≤ 5 % for Y5S and Y5U IR ≥ 3000 MΩ Dielectric strength: no failure
Robustness of termination	Pull test: 0.5 kg tensile weight in radial direction for 10 s ± 1 s Bending strength: capacitor body rotated by 90° in both directions	No damage to capacitor body and lead wire
Soldering effect	Immersion of lead wires into 260 °C ± 5 °C solder for 10 s ± 2 s; min. distance from body: 1.5 mm Hand soldering at 400 °C ± 10 °C for 3 s to 4 s; min. distance from body: 1.5 mm	External appearance: no visible damage ΔC/C ≤ ± 5 % for U2J and ≤ ± 10 % for Y5S and Y5U Dielectric strength: no failure
Vibration test	 Resin (adhesive) Solder the capacitor onto test jig (glass epoxy body) and use resin (adhesive) to stick the body to the test jig. The capacitor must be soldered firmly to the supporting lead wire. Vibration change from 10 Hz to 2000 Hz and back to 10 Hz; Total amplitude: 1.5 mm; Acceleration: 100 m/s ² ; Sweep rate: 1 oct/min, each axis 2 h (6 h in total)	External appearance: no visible damage Capacitance within specified tolerance DF ≤ 0.3 % for U2J and ≤ 2.5 % for Y5S and Y5U IR ≥ 10 000 GΩ



LEAKAGE CURRENT VS. VOLTAGE (Typical)

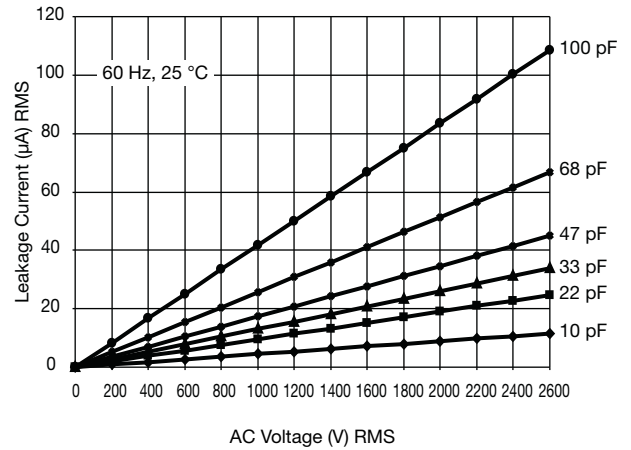

Note

- The capacitors meet the essential requirements of EIA 198. Unless stated otherwise all electrical values apply at an ambient temperature of 25 °C ± 3 °C, at normal atmospheric conditions

RELATED DOCUMENTS	
General Information	www.vishay.com/doc?28536
CB Test Certificate	www.vishay.com/doc?22254
VDE Marks Approval	www.vishay.com/doc?22256
UL Test Certificate	www.vishay.com/doc?22253
CQC Test Certificate	www.vishay.com/doc?22255
LTspice® Models	www.vishay.com/doc?28568

SAMPLE KITS	
Part Number (VY2 Sample Kit)	VY21-KIT-HF
Link (VY2 Sample Kit)	www.vishay.com/doc?28554
Part Number (VY2...Y5V Sample Kit)	VY2-KIT-MS
Link (VY2...Y5V Sample Kit)	www.vishay.com/doc?28562



Disclaimer

ALL PRODUCT, PRODUCT SPECIFICATIONS AND DATA ARE SUBJECT TO CHANGE WITHOUT NOTICE TO IMPROVE RELIABILITY, FUNCTION OR DESIGN OR OTHERWISE.

Vishay Intertechnology, Inc., its affiliates, agents, and employees, and all persons acting on its or their behalf (collectively, "Vishay"), disclaim any and all liability for any errors, inaccuracies or incompleteness contained in any datasheet or in any other disclosure relating to any product.

Vishay makes no warranty, representation or guarantee regarding the suitability of the products for any particular purpose or the continuing production of any product. To the maximum extent permitted by applicable law, Vishay disclaims (i) any and all liability arising out of the application or use of any product, (ii) any and all liability, including without limitation special, consequential or incidental damages, and (iii) any and all implied warranties, including warranties of fitness for particular purpose, non-infringement and merchantability.

Statements regarding the suitability of products for certain types of applications are based on Vishay's knowledge of typical requirements that are often placed on Vishay products in generic applications. Such statements are not binding statements about the suitability of products for a particular application. It is the customer's responsibility to validate that a particular product with the properties described in the product specification is suitable for use in a particular application. Parameters provided in datasheets and / or specifications may vary in different applications and performance may vary over time. All operating parameters, including typical parameters, must be validated for each customer application by the customer's technical experts. Product specifications do not expand or otherwise modify Vishay's terms and conditions of purchase, including but not limited to the warranty expressed therein.

Hyperlinks included in this datasheet may direct users to third-party websites. These links are provided as a convenience and for informational purposes only. Inclusion of these hyperlinks does not constitute an endorsement or an approval by Vishay of any of the products, services or opinions of the corporation, organization or individual associated with the third-party website. Vishay disclaims any and all liability and bears no responsibility for the accuracy, legality or content of the third-party website or for that of subsequent links.

Vishay products are not designed for use in life-saving or life-sustaining applications or any application in which the failure of the Vishay product could result in personal injury or death unless specifically qualified in writing by Vishay. Customers using or selling Vishay products not expressly indicated for use in such applications do so at their own risk. Please contact authorized Vishay personnel to obtain written terms and conditions regarding products designed for such applications.

No license, express or implied, by estoppel or otherwise, to any intellectual property rights is granted by this document or by any conduct of Vishay. Product names and markings noted herein may be trademarks of their respective owners.

Looking for pricing, stock, or lifecycle information?

Click below to explore more details on WIN SOURCE:

 [View VY2222M35Y5US63V0 on WIN SOURCE](#)

 [Vishay Information](#)

Optimize Your Supply Chain with WIN SOURCE Solutions

-  Global Sourcing Solution
-  Obsolete Management
-  Cost Control Management
-  Shortage Management
-  Alternative Solution
-  Excess Inventory Management