

# General Purpose AC/DC EMC/RFI Filter



Images are for reference only. Please see product specifications

- Rated currents from 1 to 60 A
- General purpose filtering performance
- Optional medical versions (B type)
- Optional safety versions (A type)
- Optional enhanced performance versions
- Optional DC optimized versions



### Performance indicators

Attenuation performance



Rated current [A]



### Approvals & Compliances



### Features and Benefits

- FN 2010 filters are designed for easy and fast chassis mounting
- FN 2010 B versions without capacitors to earth comply to 1MOP for ME (medical equipment) acc. IEC 60601-1
- FN 2010 A versions with low capacitance to earth for safety critical applications with necessity for low leakage currents
- FN 2010 filters are also available as enhanced performance and DC optimized versions. With higher attenuation in very compact housing (M, N1,N types)
- All filters provide a general purpose conducted attenuation performance, based on chokes with high saturation resistance and excellent thermal behavior
- FN 2010 filters can be used to cover a broad range of usage and they offer a good size/amperage ratio
- Various terminal options allow you to select the desired connection style

## Technical Specifications

<b>Maximum continuous operating voltage</b>	250 VAC, 50/60 Hz 250 VDC
<b>Nominal operating voltage</b>	230 VAC
<b>Rated currents</b>	1 to 60 A @ 40°C
<b>Operating frequency</b>	DC to 400 Hz
<b>High potential test voltage</b>	P → N 1100 VDC for 2 sec P → PE 2000 VAC for 2 sec (equiv. cap <88 nF) P → PE 2550 VDC for 2 sec (equiv. cap >88 nF) P → PE 2500 VAC for 2 sec (B types)
<b>Overvoltage category</b>	II acc. IEC 60664-1
<b>Pollution degree</b>	2 acc. IEC 60664-1
<b>Temperature range (operation and storage)</b>	-25 °C to +100 °C (25/100/21)**
<b>Altitude</b>	2000m (above derating applies)**
<b>Flammability corresponding to</b>	Laces for -07 version: UL 94 VW-1 Terminal plastic for -06/-08 version: UL 94 V-0 Grommet for -07 version: UL 94 V-0
<b>Certified to</b>	UL 1283, CSA 22.2 No. 8 1986, IEC/EN 60939 (applies to AC and DC applications)
<b>MTBF (Mil-HB-217F)</b>	>1,250,000 h @ 40°C/230 V 3,200,000 h (B types) @ 40°C/230 V

\* maximum RMS operating voltage at rated frequency or the maximum DC operating voltage  
 \*\* for dedicated requests exceeding this specification (e.g. -40 °C or higher altitude) please contact your local Schaffner sales office







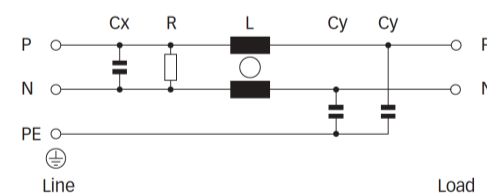































### Typical Applications

- Electrical and electronic equipment
- Consumer goods
- Household equipment
- Medical equipment
- Office automation equipment
- Datacom equipment

### Typical electrical schematic



## Filter Selection Table

Filter*	Buy	Rated current @ 40°C (25°C)	Leakage current** @ 250 VAC/50 Hz (@ 120 VAC/60 Hz)	Power loss @25°C/DC	Inductance***		Capacitance***		Resistance***	Input/Output connections			Weight [g]
					L	Cx	Cy	R					
		[A]	[mA]	[W]	[mH]	[µF]	[nF]	[kΩ]					
FN2010-1-..		1 (1.15)	0.66 (0.38)	0.8	12	0.1	4.7	1000	-06	-07		65	
FN2010-3-..		3 (3.45)	0.66 (0.38)	1.1	2.5	0.1	4.7	1000	-06	-07		65	
FN2010-6-..		6 (6.9)	0.66 (0.38)	1.7	1	0.1	4.7	1000	-06	-07		65	
FN2010-10-..		10 (11.5)	0.66 (0.38)	2.5	0.8	0.1	4.7	1000	-06	-07		85	
FN2010-12-..		12 (13.8)	0.66 (0.38)	3.6	0.7	0.1	4.7	1000	-06	-07		85	
FN2010-16-..		16 (18.4)	0.66 (0.38)	2.5	0.7	0.1	4.7	1000	-06	-07	-08	140	
FN2010-20-..		20 (23)	0.66 (0.38)	3.8	0.6	0.1	4.7	1000	-06	-07	-08	210	
FN2010-30-08		30 (34.5)	0.79 (0.46)	6.3	0.7	0.47	10	1000			-08	470	
FN2010-60-24		60 (69)	0.79 (0.46)	14.7	1	1.5	10	330			-24	1100	
<b>Enhanced performance</b>													
FN2010A-1-..		1 (1.15)	0.07 (0.04)	0.8	12	0.1	0.47	1000	-06	-07		65	
FN2010A-3-..		3 (3.45)	0.07 (0.04)	1.1	2.5	0.1	0.47	1000	-06	-07		65	
FN2010A-6-..		6 (6.9)	0.07 (0.04)	1.7	1	0.1	0.47	1000	-06	-07		65	
FN2010A-10-..		10 (11.5)	0.07 (0.04)	2.5	0.8	0.1	0.47	1000	-06	-07		85	
FN2010A-12-..		12 (13.8)	0.07 (0.04)	3.6	0.7	0.1	0.47	1000	-06	-07		85	
FN2010A-16-..		16 (18.4)	0.07 (0.04)	2.5	0.7	0.1	0.47	1000	-06	-07	-08	140	
FN2010A-20-..		20 (23)	0.07 (0.04)	3.8	0.6	0.1	0.47	1000	-06	-07	-08	210	
FN2010A-30-08		30 (34.5)	0.07 (0.04)	6.3	0.7	0.47	0.47	1000			-08	470	
FN2010A-60-24		60 (69)	0.07 (0.04)	14.7	1	1.5	0.47	330			-24	1100	
FN2010B-1-..		1 (1.15)	0.00	0.8	12	0.1		1000	-06	-07		65	
FN2010B-3-..		3 (3.45)	0.00	1.1	2.5	0.1		1000	-06	-07		65	
FN2010B-6-..		6 (6.9)	0.00	1.7	1	0.1		1000	-06	-07		65	
FN2010B-10-..		10 (11.5)	0.00	2.5	0.8	0.1		1000	-06	-07		85	
FN2010B-12-..		12 (13.8)	0.00	3.6	0.7	0.1		1000	-06	-07		85	
FN2010B-16-..		16 (18.4)	0.00	2.5	0.7	0.1		1000	-06	-07	-08	140	
FN2010B-20-..		20 (23)	0.00	3.8	0.6	0.1		1000	-06	-07	-08	210	
FN2010B-30-08		30 (34.5)	0.00	6.3	0.7	0.47		1000			-08	470	
FN2010B-60-24		60 (69)	0.00	14.7	1	1.5		330			-24	1100	
FN2010N1-1-06		1 (1.15)	5.34 (3.08)	0.8	12	0.1	68	1000	-06			70	
FN2010N1-3-06		3 (3.45)	5.34 (3.08)	1.1	2.5	0.1	68	1000	-06			70	
FN2010N1-6-06		6 (6.9)	5.34 (3.08)	1.7	1	0.1	68	1000	-06			70	
FN2010N1-10-06		10 (11.5)	5.34 (3.08)	2.5	0.8	0.1	68	1000	-06			85	
FN2010N1-12-06		12 (13.8)	3.69 (2.13)	3.6	0.7	0.1	47	1000	-06			85	
FN2010M-16-..		16 (18.4)	3.69 (2.13)	2.5	0.7	0.1	47	1000	-06		-08	140	
FN2010M-20-..		20 (23)	3.69 (2.13)	3.8	0.6	0.1	47	1000	-06		-08	220	
FN2010N-30-08		30 (34.5)	7.85 (4.52)	6.3	0.7	0.47	100	1000			-08	400	
FN2010N-60-24		60 (69)	7.85 (4.52)	14.7	1	1.5	100	330			-24	1120	

\* To compile a complete part number, please replace the -.. with the required I/O connection style (e.g. FN 2010-30-08, FN 2010B-10-06). The different letters code the used Cy values in the filter type (A = 0.47nF; M = 47nF; N1 = 47nF; N = 100nF)

\*\* Maximum leakage under usual AC operating conditions (acc. IEC 60939-3). Note: if the neutral line is interrupted, worst case leakage could reach twice this level.

\*\*\* Tolerances apply: Inductance: -30/+50%, Capacitance: ±20%, Resistance: ±10%

## Typical Filter Attenuation

Per CISPR 17: symmetrical 50 Ω/50 Ω -> Differential Mode (DM); asymmetrical 50 Ω/50 Ω -> Common Mode (CM)

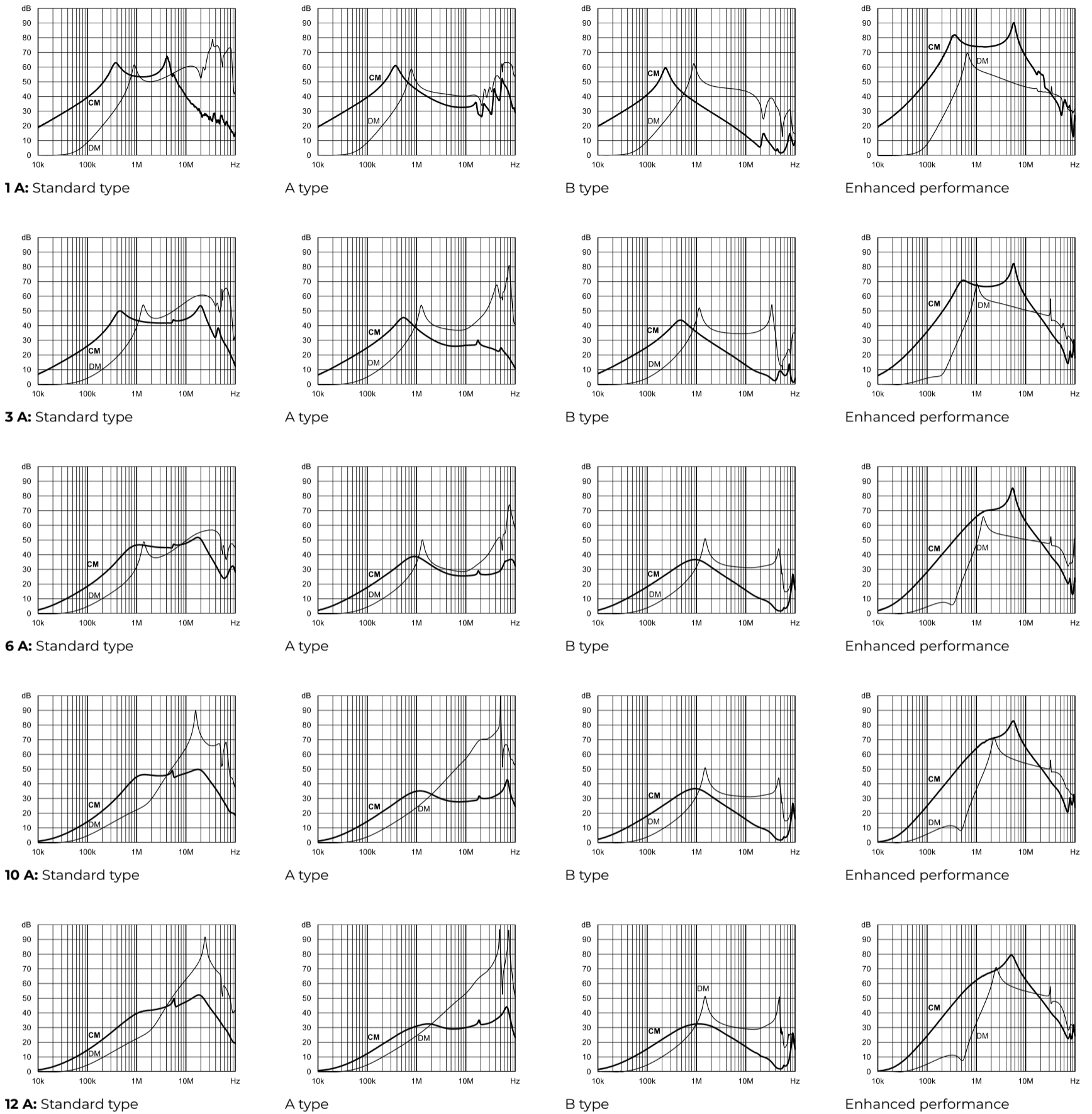

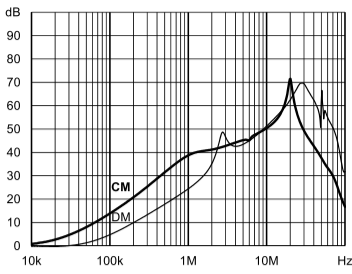

16 A: Standard type

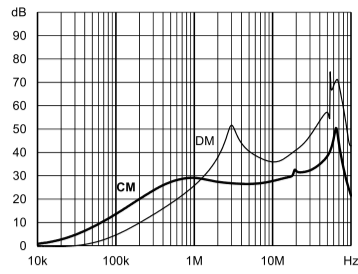

A type

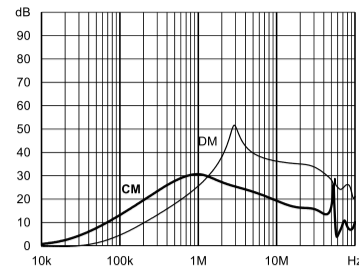

B type

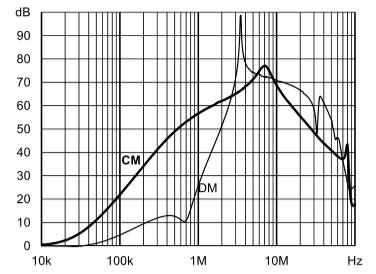

Enhanced performance

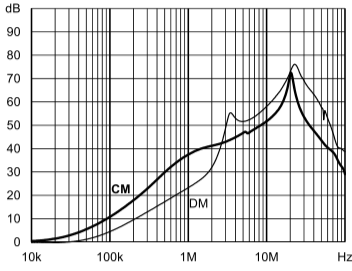

20 A: Standard type

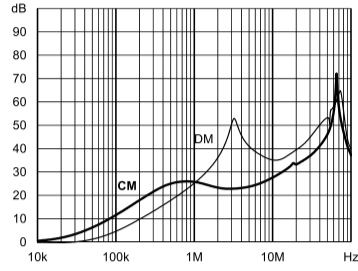

A type

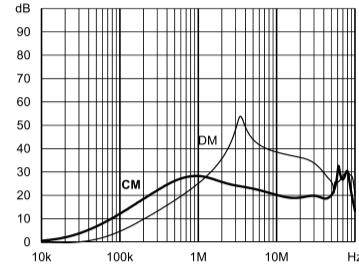

B type

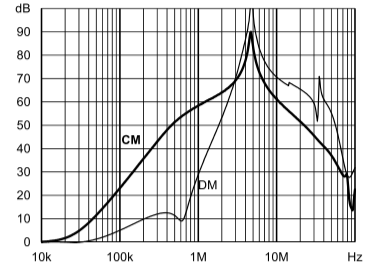

Enhanced performance

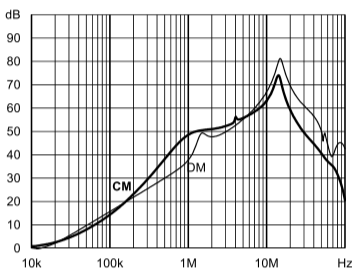

30 A: Standard type

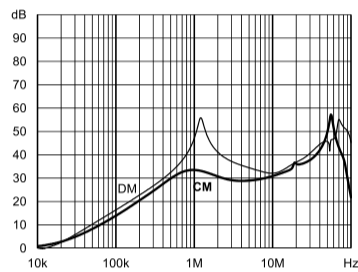

A type

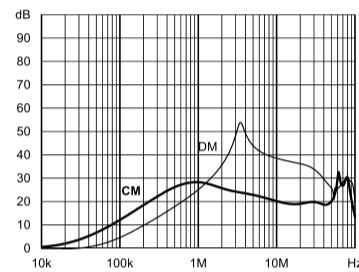

B type

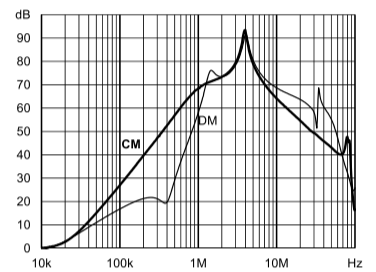

Enhanced performance

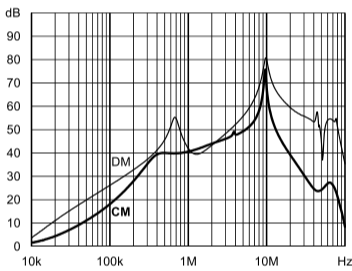

60 A: Standard type

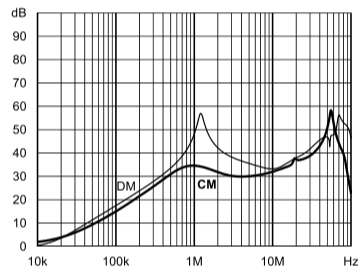

A type

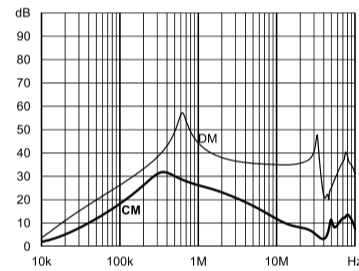

B type

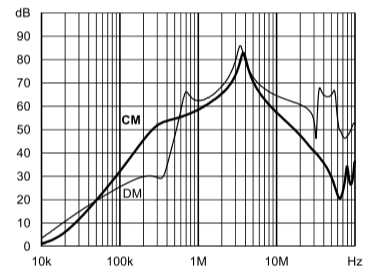

Enhanced performance

Product Selector		
FN 2010-xy-xx-yy		
	06	Faston 6.3 × 0.8 mm (spade/soldering)
	07	Wire leads
	08	Studs (M4 screws)
	24	Studs (M6 screws)
	1 to 60	Rated current
	Blank	Standard version
	Z	With surge protection
	Blank	Standard version
	A	Safety version
	B	Medical version
	N1/N/M	High performance version

### Mechanical Data

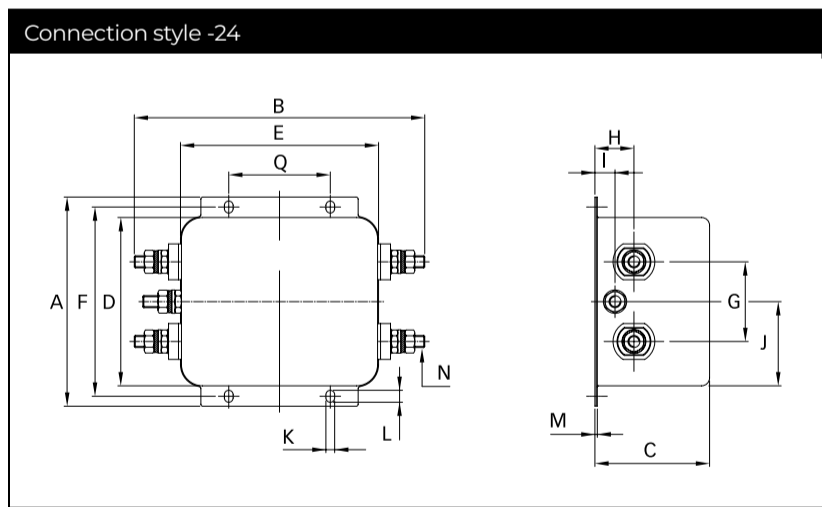
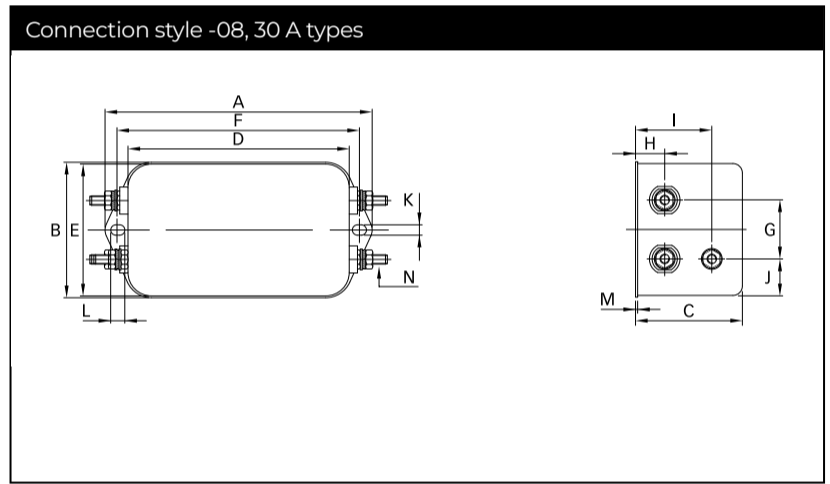
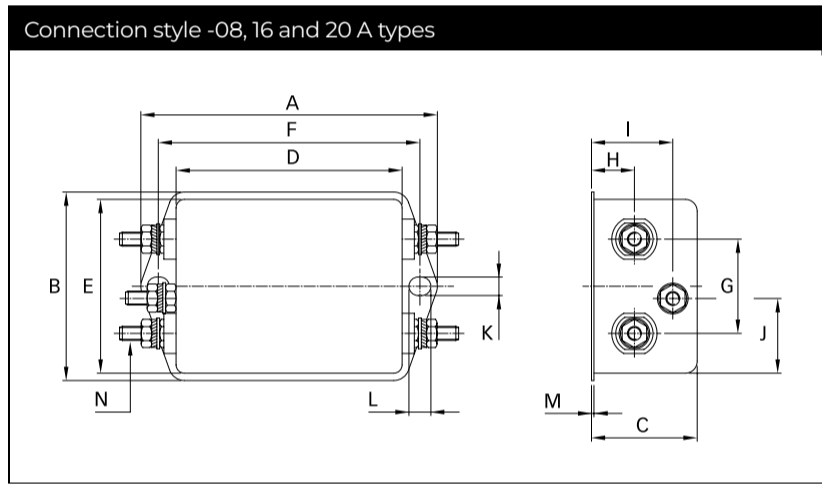
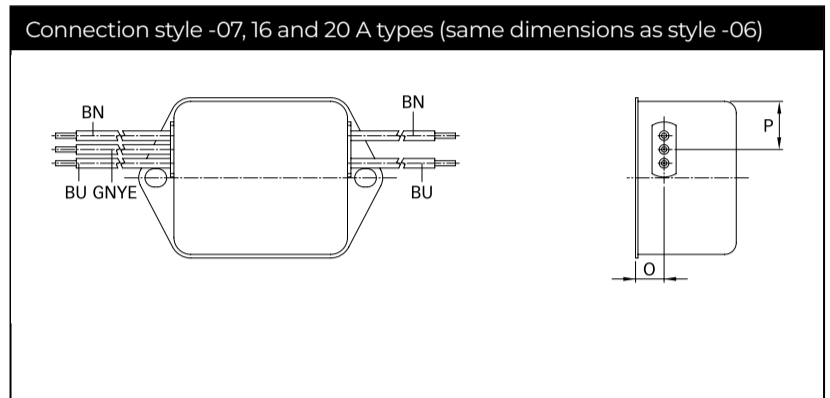
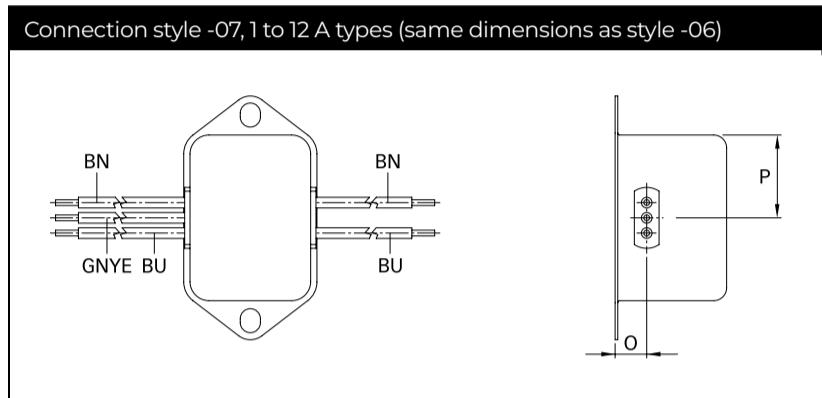
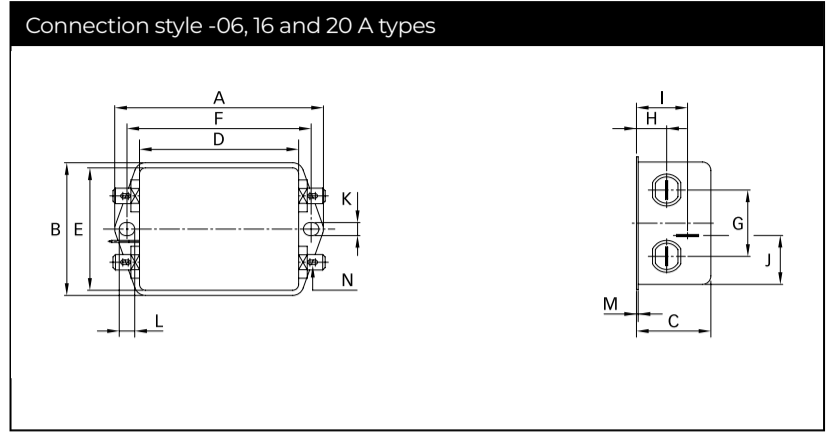
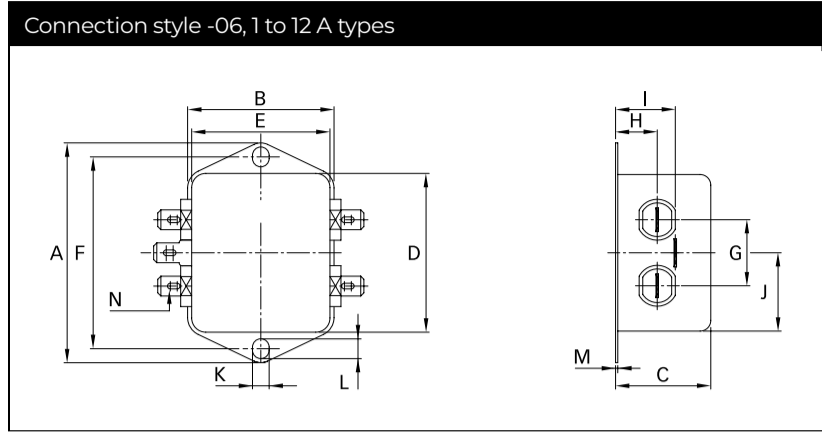

## Dimensions

	1 A	3 A	6 A	10 A	12 A	16 A	20 A	30 A	60 A	Tolerances
<b>A</b>	64	64	64	64	64	71	85	113.5 ±1	105 ±1	±0.5
<b>B</b>	35	35	35	35	35	46.6	54	57.5 ±1	145.9 ±1	±0.5
<b>C</b>	24.3	24.3	24.3	29.3	29.3	29.3	30.3	45.4 ±1	57.6 ±1	±0.5
<b>D</b>	43.5	43.5	43.5	43.5	43.5	50.5	64.8	94 ±1	84.5 ±1	±0.5
<b>E</b>	32.5	32.5	32.5	32.5	32.5	44.5	49.8	56	99.5	±0.5
<b>F</b>	54	54	54	54	54	61	75	103	95	±0.3
<b>G</b>	21	21	21	21	21	21	27	25	40	±0.2
<b>H</b>	9.3	9.3	9.3	9.3	9.3	10.8	12.3	12.4	19.6	±0.5
<b>I</b>	15.3	15.3	15.3	15.3	15.3	19.3	20.8	32.4	10.1	±0.5
<b>J</b>	21.8	21.8	21.8	21.8	21.8	20.1	19.9	15.5	42.25	±0.5
<b>K</b>	5.3	5.3	5.3	5.3	5.3	5.3	5.3	4.4	4.4	
<b>L</b>	6.3	6.3	6.3	6.3	6.3	6.3	6.3	6	6	
<b>M</b>	0.7	0.7	0.7	0.7	0.7	0.7	0.7	1	1.2	±0.3
<b>Connection style -06</b>										
<b>N</b>	6.3 x 0.8	6.3 x 0.8	6.3 x 0.8	6.3 x 0.8	6.3 x 0.8	6.3 x 0.8	6.3 x 0.8			
<b>Connection style -07</b>										
<b>O</b>	8.3	8.3	8.3	8.3	8.3	8.3	8.3			±0.5
<b>P</b>	21.8	21.8	21.8	21.8	21.8	14	14.9			±0.5
<b>AWG type wire</b>	AWG 20	AWG 20	AWG 18	AWG 18	AWG 16	AWG 16	AWG 14			
<b>Wire length</b>	140	140	140	140	140	140	140			+5
<b>Connection style -08</b>										
<b>N</b>						M4	M4	M4		
<b>Recommended torque (Nm)</b>						1.2 - 1.3	1.2 - 1.3	1.2 - 1.3		
<b>Earth terminal</b>						1.5 - 1.7	1.5 - 1.7	1.5 - 1.7		
<b>Connection style -24</b>										
<b>N</b>									M6	
<b>Q</b>									51	±0.2
<b>Recommended torque (Nm)</b>									3.5 - 4	
<b>Earth Terminal</b>									3.5 - 4	

All dimensions in mm; 1 inch = 25.4 mm  
Tolerances according: ISO 2768-m/EN 22768-m

Please visit [www.schaffner.com](http://www.schaffner.com) to find more details on filter connections.

## We are here to help



Read more insights from TE's experts:

## Connect With Us

We make it easier to connect with our experts and are ready to provide the support you need. Visit [te.com/support](https://te.com/support) to chat with a Product Information Specialist.

## te.com

©2025 TE Connectivity plc. All Rights Reserved.

TE Connectivity, TE, TE connectivity (logo), and EVERY CONNECTION COUNTS, ECOSine, Schaffner are trademarks owned or licensed by TE Connectivity plc. family of companies. All other logos, products and/or company names referred to herein might be trademarks of their respective owners.

While TE has made every reasonable effort to ensure the accuracy of the information in this document, TE does not guarantee that it is error-free, nor does TE make any other representation, warranty or guarantee that the information is accurate, correct, reliable or current. TE reserves the right to make any changes to the information contained herein without prior notice. TE Connectivity assumes only those obligations set forth in the terms and conditions for this product and shall in no event be liable for any incidental, indirect, or consequential damages arising out of the sale, resale, use, or misapplication of the product. TE expressly disclaims any implied warranties with respect to the information contained herein, including, but not limited to, implied warranties of merchantability or fitness for a particular purpose. Dimensions, specifications and/or information contained herein are for reference purposes only and are subject to change without notice. Consult TE for the latest dimensions, specifications and/or information. Users of TE Connectivity products must make their own assessment as to whether the respective product is suitable for the respective desired application.

ED 01/25

**schaffner**  
MORE POWER TO YOU

is now part of

**TE**  
connectivity

## Looking for pricing, stock, or lifecycle information?

Click below to explore more details on WIN SOURCE:

- [View FN2010-1-07 on WIN SOURCE](#)
- [Schaffner EMC Inc. Information](#)

## Optimize Your Supply Chain with WIN SOURCE Solutions

- ✓ Global Sourcing Solution
- ✓ Obsolete Management
- ✓ Cost Control Management
- ✓ Shortage Management
- ✓ Alternative Solution
- ✓ Excess Inventory Management