



**THE DATASHEET OF
C317C103K5R5TA7301**



Goldmax, 300 Series, Conformally Coated, X7R Dielectric, 25 – 250 VDC (Commercial Grade)

Overview

KEMET's Goldmax conformally coated radial leaded ceramic capacitors in X7R dielectric feature a 125°C maximum operating temperature. The Electronics Industries Alliance (EIA) characterizes X7R dielectric as a Class II "temperature stable" material. Components of this classification are fixed, ceramic dielectric capacitors suited for bypass and decoupling applications or for frequency discriminating circuits where Q and stability of capacitance characteristics are not critical. X7R

exhibits a predictable change in capacitance with respect to time and voltage and boasts a minimal change in capacitance with reference to ambient temperature. Capacitance change is limited to $\pm 15\%$ from -55°C to $+125^{\circ}\text{C}$.

These devices meet the flame test requirements outlined in UL Standard 94V-0.

Benefits

- Radial leaded form factor
- Conformally coated
- 0.100", 0.200", 0.250" and 0.400" lead spacing
- -55°C to $+125^{\circ}\text{C}$ operating temperature range
- Lead (Pb)-free, RoHS and REACH compliant
- X7R temperature stable dielectric



Ordering Information

C	320	C	106	K	3	R	5	T	A	7301
Ceramic	Style/Size	Specification/ Series	Capacitance Code (pF)	Capacitance Tolerance ¹	Rated Voltage (VDC)	Dielectric	Design	Lead Finish ²	Failure Rate	Packaging (C-Spec)
	315 324 335 316 325 336 317 326 340 318 327 346 320 328 350 321 330 356 322 331 323 333	C = Standard	First two digits represent significant figures. Third digit specifies number of zeros.	J = $\pm 5\%$ K = $\pm 10\%$ M = $\pm 20\%$	3 = 25 5 = 50 1 = 100 2 = 200 A = 250	R = X7R	5 = Multilayer	T = 100% Matte Sn H = SnPb (60/40)	A = N/A	See "Packaging C-Spec Ordering Options Table" below

¹ Additional capacitance tolerance offerings may be available. Contact KEMET for details.

² Lead materials:

Standard: 100% matte tin (Sn) with nickel (Ni) underplate and steel core ("T" designation).

Alternative 1: 60% tin (Sn)/40% lead (Pb) finish with copper-clad steel core ("H" designation).

Alternative 2: 60% tin (Sn)/40% lead (Pb) finish with 100% copper core (available with "H" designation code with C-Spec). Contact KEMET for C-Spec details.

Built Into Tomorrow

Benefits cont.

- DC voltage ratings of 25 V, 50 V, 100 V, 200 V and 250 V
- Capacitance offerings ranging from 100 pF to 10 μ F
- Available capacitance Tolerances of $\pm 5\%$, $\pm 10\%$ and $\pm 20\%$
- Non-polar device, minimizing installation concerns
- 100% pure matte tin-plated lead finish allowing for excellent solderability
- SnPb-plated lead finish option available upon request (Sn60/Pb40)
- Encapsulation meets flammability standard UL 94V-0

Applications

Typical applications include decoupling, bypass, filtering and transient voltage suppression.

Application Notes

These devices are not recommended for use in overmold applications and/or processes.

Packaging C-Spec Ordering Options Table

Packaging Type ¹	Packaging/Grade Ordering Code (C-Spec)
Bulk Bag	Not required (Blank)
12" Tape & Reel (16.0 \pm 0.5 mm lead length)	7301
12" Tape & Reel (18.0 mm minimum lead length)	7303 and TR
Ammo Pack (16.0 \pm 0.5 mm lead length)	7305
Ammo Pack (18.0 mm minimum lead length)	7317

¹ Default packaging is "Bulk Bag". An ordering code C-Spec is not required for "Bulk Bag" packaging. Bulk bag option is required for Size/Style C321 and C331.

¹ "Tape and Reel" packaging option is not available for Size/Style C321 and C331. For more information see "Packaging Quantities".

¹ "Ammo Pack" packaging option is not available for Size/Style C321, C331, C350 and C356. For more information see "Packaging Quantities".

¹ "Ammo Pack" and "Tape and Reel" packaging options have the same lead tape configuration. For more information see "Tape & Reel Packaging Information".

Qualification/Certification

Commercial Grade products are subject to internal qualification. Details regarding test methods and conditions are referenced in Table 2, Performance & Reliability.

Dimensions – Inches (Millimeters)

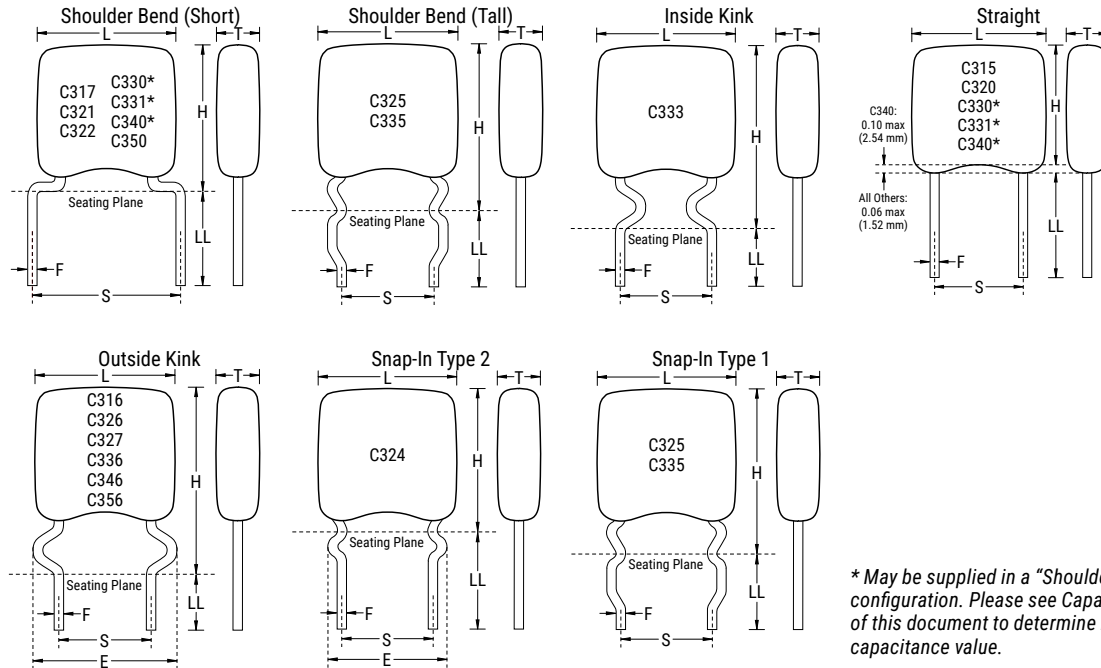

* May be supplied in a "Shoulder Bend" or "Straight" Lead configuration. Please see Capacitance Range Waterfall section of this document to determine lead configuration availability by capacitance value.

Series	Style / Size	S Lead Spacing ±0.030 (0.78)	L Length Maximum	H Height Maximum	T Thickness Maximum	F Lead Diameter +0.004 (0.10), -0.001 (0.025)	LL Lead Length Minimum
C31X	315	0.100 (2.54)	0.150 (3.81)	0.120 (3.14)	0.100 (2.54)	0.020 (0.51)	0.276 (7.00)
	316		0.150 (3.81)	0.230 (5.84)	0.100 (2.54)		0.200 (5.08)
C32X	324	0.100 (2.54)	0.200 (5.08)	0.230 (5.84)	0.125 (3.18) ¹		0.276 (7.00)
	320		0.200 (5.08)	0.230 (5.84)	0.125 (3.18) ¹		0.276 (7.00)
C31X	326	0.200 (5.08)	0.200 (5.08)	0.300 (7.62)	0.125 (3.18) ¹		0.200 (5.08)
	317		0.150 (3.81)	0.200 (5.08)	0.100 (2.54)		0.276 (7.00)
C32X	318	0.200 (5.08)	0.150 (3.81)	0.235 (5.97)	0.100 (2.54)		0.276 (7.00)
	321		0.200 (5.08)	0.260 (6.60)	0.125 (3.18) ¹		0.276 (7.00)
	322		0.200 (5.08)	0.260 (6.60)	0.125 (3.18) ¹		0.276 (7.00)
	323		0.200 (5.08)	0.300 (7.62)	0.125 (3.18) ¹		0.276 (7.00)
	325		0.200 (5.08)	0.300 (7.62)	0.125 (3.18) ¹	0.276 (7.00)	
	328		0.200 (5.08)	0.300 (7.62)	0.125 (3.18) ¹	0.276 (7.00)	
C33X	327	0.250 (6.35)	0.200 (5.08)	0.320 (8.13)	0.125 (3.18) ¹	0.200 (5.08)	
	330		0.280 (7.11)	0.360 (9.14) ²	0.160 (4.07)	0.276 (7.00)	
	331		0.250 (6.35)	0.300 (7.62)	0.360 (9.14) ²	0.160 (4.07)	0.276 (7.00)
	333		0.280 (7.11)	0.400 (10.16)	0.160 (4.07)	0.276 (7.00)	
C34X	335	0.200 (5.08)	0.280 (7.11)	0.400 (10.16)	0.160 (4.07)	0.200 (5.08)	
	336		0.280 (7.11)	0.400 (10.16)	0.160 (4.07)	0.276 (7.00)	
C35X	340	0.200 (5.08)	0.290 (7.36)	0.400 (10.16)	0.160 (4.07)	0.276 (7.00)	
	346		0.290 (7.36)	0.400 (10.16)	0.160 (4.07)	0.200 (5.08)	
C35X	350	0.400 (10.16)	0.330 (8.38)	0.400 (10.16)	0.200 (5.08)	0.276 (7.00)	
	356		0.330 (8.38)	0.400 (10.16)	0.200 (5.08)	0.200 (5.08)	

¹ Thickness maximum (T) = 0.160" (4.07 mm) for capacitance values greater than or equal to 4.7 μF

² Height max. (H) = 0.400" (10.16 mm) for C330 & C331 with shoulder bend leads (see capacitance range waterfall table).

Environmental Compliance

Lead (Pb)-free, REACH and RoHS compliant without exemptions when ordered with a 100% tin (Sn) wire lead finish. Product ordered with tin/ lead (Sn60/Pb40) wire lead finish do not meet RoHS criteria.

Series	Termination Finish (Wire Lead)	RoHS Compliant	RoHS Exemption Code	REACH Compliant ¹	Halogen Free
300 (C3XX)	100% Matte Sn	Yes	n/a	Yes	Yes
	Sn60/Pb40	No	n/a	Yes	Yes

¹ REACH compliance indicates product does not contain Substance/s of Very High Concern (SVHC)

Electrical Parameters/Characteristics

Item	Parameters/Characteristics
Operating Temperature Range	-55°C to +125°C
Capacitance Change with Reference to +25°C and 0 VDC Applied (TCC)	±15%
Aging Rate (Maximum % Cap Loss/Decade Hour)	3.0%
Dielectric Withstanding Voltage	250% of rated voltage (5±1 second and charge/discharge not exceeding 50 mA at 25°C)
Dissipation Factor (DF) Maximum Limit at 25°C	See Dissipation Factor Limit Table
Insulation Resistance (IR) Limit at 25°C	See Insulation Resistance Limit Table (Rated voltage applied for 120±5 seconds at 25°C)

Regarding Aging Rate: Capacitance measurements (including tolerance) are indexed to a referee time of 48 or 1,000 Hours. Please refer to a part number specific datasheet for referee time details.

To obtain IR limit, divide MQ-μF value by the capacitance and compare to GΩ limit. Select the lower of the two limits.

Capacitance and dissipation factor (DF) measured under the following conditions:

$$1 \text{ kHz } \pm 50 \text{ Hz and } 1.0 \pm 0.2 V_{\text{rms}}$$

Note: When measuring capacitance it is important to ensure the set voltage level is held constant. The HP4284 and Agilent E4980 have a feature known as Automatic Level Control (ALC). The ALC feature should be switched to "ON."

Insulation Resistance Limit Table

Style/Size	1,000 megohm microfarads or 100GΩ	500 megohm microfarads or 10GΩ	100 Megohm Microfarads or 10GΩ
C31X	< 0.12 μF	≥ 0.12 μF	NA
C32X	< 0.18 μF	NA	≥ 0.18 μF
C33X	< 0.18 μF	NA	≥ 0.18 μF
C34X	< 1.20 μF	≥ 1.20 μF	NA
C35X	< 2.70 μF	≥ 2.70 μF	NA

Post Environmental Limits

High Temperature Life, Biased Humidity and Storage Life					
Style/Size	Rated DC Voltage	Capacitance Value	Dissipation Factor (Maximum %)	Capacitance Shift	Insulation Resistance
C31X	25	All	5.0	±20%	10% of Initial Limit
	> 25	< 1.0 µF	3.0		
≥ 1.0 µF		20.0			
C32X, C33X, C34X	25	< 2.2 µF	5.0		
	> 25	< 2.2 µF	3.0		
	25/50	≥ 2.2 µF	20.0		
C35X	25	All	5.0		
	> 25		3.0		

Dissipation Factor (DF) Limit Table

Style/Size	Rated DC Voltage	Rated Capacitance	Dissipation Factor (Maximum %)
C31X	25	All	3.5
	> 25	< 1.0 µF	2.5
		≥ 1.0 µF	10.0
C32X, C33X, C34X	25	< 2.2 µF	3.5
	> 25	< 2.2 µF	2.5
	25 / 50	≥ 2.2 µF	10.0
C35X	25	All	3.5
	> 25		2.5

Table 1A – C31X Style/Size, Capacitance Range Waterfall

C315, C316, C317, C318 Style/Size (0.100" and 0.200" Lead Spacing)						
Rated Voltage (VDC)		25	50	100	200	250
Voltage Code		3	5	1	2	A
Capacitance	Capacitance Tolerance	Capacitance Code (Available Capacitance)				
100pF	J = ±5% K = ±10% M = ±20%	101	101	101	101	101
120pF		121	121	121	121	121
150pF		151	151	151	151	151
180pF		181	181	181	181	181
220pF		221	221	221	221	221
270pF		271	271	271	271	271
330pF		331	331	331	331	331
390pF		391	391	391	391	391
470pF		471	471	471	471	471
560pF		561	561	561	561	561
680pF		681	681	681	681	681
820pF		821	821	821	821	821
1000pF		102	102	102	102	102
1200pF		122	122	122	122	122
1500pF		152	152	152	152	152
1800pF		182	182	182	182	182
2200pF		222	222	222	222	222
2700pF		272	272	272	272	272
3300pF		332	332	332	332	332
3900pF		392	392	392	392	392
4700pF		472	472	472	472	472
5600pF		562	562	562	562	562
6800pF		682	682	682	682	682
8200pF		822	822	822	822	822
0.01µF		103	103	103	103	103
0.012µF		123	123	123	123	123
0.015µF		153	153	153	153	153
0.018µF		183	183	183	183	183
0.022µF		223	223	223	223	223
0.027µF		273	273	273	273	273
0.033µF		333	333	333	333	333
0.039µF		393	393	393	393	393
0.047µF		473	473	473	473	473
0.056µF		563	563	563	563	563
0.068µF		683	683	683	683	683
0.082µF		823	823	823		
0.1µF		104	104	104		
0.12µF		124	124	124		
0.15µF		154	154	154		
0.18µF		184	184	184		
0.22µF		224	224	224		
0.27µF		274	274			
0.33µF		334	334			
0.39µF		394	394			
0.47µF		474	474			
0.56µF	564	564				
0.68µF	684	684				
1.0µF	105	105*				
Rated Voltage (VDC)		25	50	100	200	250
Voltage Code		3	5	1	2	A

* Only available on K and M tolerances.

Table 1B – C32X Style/Size, Capacitance Range Waterfall

C320, C322, C323, C326, C328 Style/Size (0.100" and 0.200" Lead Spacing)						
Rated Voltage (VDC)		25	50	100	200	250
Voltage Code		3	5	1	2	A
Capacitance	Capacitance Tolerance	Capacitance Code (Available Capacitance)				
100pF	J = ±5% K = ±10% M = ±20%	101	101	101	101	101
120pF		121	121	121	121	121
150pF		151	151	151	151	151
180pF		181	181	181	181	181
220pF		221	221	221	221	221
270pF		271	271	271	271	271
330pF		331	331	331	331	331
390pF		391	391	391	391	391
470pF		471	471	471	471	471
560pF		561	561	561	561	561
680pF		681	681	681	681	681
820pF		821	821	821	821	821
1000pF		102	102	102	102	102
1200pF		122	122	122	122	122
1500pF		152	152	152	152	152
1800pF		182	182	182	182	182
2200pF		222	222	222	222	222
2700pF		272	272	272	272	272
3300pF		332	332	332	332	332
3900pF		392	392	392	392	392
4700pF		472	472	472	472	472
5600pF		562	562	562	562	562
6800pF		682	682	682	682	682
8200pF		822	822	822	822	822
0.01μF		103	103	103	103	103
0.012μF		123	123	123	123	123
0.015μF		153	153	153	153	153
0.018μF		183	183	183	183	183
0.022μF		223	223	223	223	223
0.027μF		273	273	273	273	273
0.033μF		333	333	333	333	333
0.039μF		393	393	393	393	393
0.047μF		473	473	473	473	473
0.056μF		563	563	563	563	563
0.068μF		683	683	683	683	683
0.082μF		823	823	823	823	823
0.1μF		104	104	104	104	104
0.12μF		124	124	124	124	124
0.15μF		154	154	154	154	154
0.18μF		184	184	184	184	184
0.22μF		224	224	224	224	224
0.27μF		274	274	274		
0.33μF		334	334	334		
0.39μF		394	394	394		
0.47μF		474	474	474		
0.56μF	564	564	564			
0.68μF	684	684	684			
0.82μF	824	824	824			
1.0μF	105	105	105			
1.2μF	125	125				
1.5μF	155	155				
1.8μF	185	185				
2.2μF	225*	225*				
Rated Voltage (VDC)		25	50	100	200	250
Voltage Code		3	5	1	2	A

* Only available on K and M tolerances.

Table 1B – C32X Style/Size, Capacitance Range Waterfall cont.

C320, C322, C323, C326, C328 Style/Size (0.100" and 0.200" Lead Spacing)						
Rated Voltage (VDC)		25	50	100	200	250
Voltage Code		3	5	1	2	A
Capacitance	Capacitance Tolerance	Capacitance Code (Available Capacitance)				
2.7µF	J = ±5% K = ±10% M = ±20%	275	275			
3.3µF		335	335			
3.9µF		395	395			
4.7µF		475 ¹	475 ¹			
5.6µF		565 ¹				
6.8µF		685 ¹				
10µF		106 ¹				
Rated Voltage (VDC)		25	50	100	200	250
Voltage Code		3	5	1	2	A

¹ Thickness maximum (T) = 0.160" (4.07 mm) for capacitance values greater than or equal to 4.7 µF

Table 1C – C32X Style/Size, Capacitance Range Waterfall

C321, C324, C325, C327 Style/Size (0.100", 0.200" and 0.250" Lead Spacing)							
Rated Voltage (VDC)		25	50	100	200	250	
Voltage Code		3	5	1	2	A	
Capacitance	Capacitance Tolerance	Capacitance Code (Available Capacitance)					
100pF	J = ±5% K = ±10% M = ±20%	101	101	101	101	101	
120pF		121	121	121	121	121	
150pF		151	151	151	151	151	
180pF		181	181	181	181	181	
220pF		221	221	221	221	221	
270pF		271	271	271	271	271	
330pF		331	331	331	331	331	
390pF		391	391	391	391	391	
470pF		471	471	471	471	471	
560pF		561	561	561	561	561	
680pF		681	681	681	681	681	
820pF		821	821	821	821	821	
1000pF		102	102	102	102	102	
1200pF		122	122	122	122	122	
1500pF		152	152	152	152	152	
1800pF		182	182	182	182	182	
2200pF		222	222	222	222	222	
2700pF		272	272	272	272	272	
3300pF		332	332	332	332	332	
3900pF		392	392	392	392	392	
4700pF		472	472	472	472	472	
5600pF		562	562	562	562	562	
6800pF		682	682	682	682	682	
8200pF		822	822	822	822	822	
0.01µF		103	103	103	103	103	
0.012µF		123	123	123	123	123	
0.015µF		153	153	153	153	153	
0.018µF		183	183	183	183	183	
Rated Voltage (VDC)		25	50	100	200	250	
Voltage Code		3	5	1	2	A	

Table 1C – C32X Style/Size, Capacitance Range Waterfall cont.

C321, C324, C325, C327 Style/Size (0.100", 0.200" and 0.250" Lead Spacing)						
Rated Voltage (VDC)		25	50	100	200	250
Voltage Code		3	5	1	2	A
Capacitance	Capacitance Tolerance	Capacitance Code (Available Capacitance)				
0.022µF	J = ±5% K = ±10% M = ±20%	223	223	223	223	223
0.027µF		273	273	273	273	273
0.033µF		333	333	333	333	333
0.039µF		393	393	393	393	393
0.047µF		473	473	473	473	473
0.056µF		563	563	563	563	563
0.068µF		683	683	683	683	683
0.082µF		823	823	823	823	823
0.1µF		104	104	104	104	104
0.12µF		124	124	124	124	124
0.15µF		154	154	154	154	154
0.18µF		184	184	184	184	184
0.22µF		224	224	224	224	224
0.27µF		274	274	274		
0.33µF		334	334	334		
0.39µF		394	394	394		
0.47µF		474	474	474		
0.56µF		564	564	564		
0.68µF		684	684	684		
0.82µF		824	824	824		
1.0µF		105	105	105		
1.2µF		125	125			
1.5µF		155	155			
1.8µF		185	185			
2.2µF		225*	225*			
2.7µF		275	275			
3.3µF		335	335			
3.9µF		395	395			
4.7µF	475 ¹	475 ¹				
5.6µF	565 ¹					
6.8µF	685 ¹					
10µF	106 ¹				0	
Rated Voltage (VDC)		25	50	100	200	250
Voltage Code		3	5	1	2	A

* Only available on K and M tolerances.

¹ Thickness maximum (T) = 0.160" (4.07 mm) for capacitance values greater than or equal to 4.7 µF

Table 1D – C33X Style/Size, Capacitance Range Waterfall

C330, C331, C333, C335, C336 Style/Size (0.200" and 0.250" Lead Spacing)						
Rated Voltage (VDC)		25	50	100	200	250
Voltage Code		3	5	1	2	A
Capacitance	Capacitance Tolerance	Capacitance Code (Available Capacitance)				
4700pF	J = ±5% K = ±10% M = ±20%	472*	472*	472*	472*	472*
5600pF		562*	562*	562*	562*	562*
6800pF		682*	682*	682*	682*	682*
8200pF		822*	822*	822*	822*	822*
0.01µF		103*	103*	103*	103*	103*
0.012µF		123*	123*	123*	123*	123*
0.015µF		153*	153*	153*	153*	153*
0.018µF		183*	183*	183*	183*	183*
0.022µF		223*	223*	223*	223*	223*
0.027µF		273*	273*	273*	273*	273*
0.033µF		333*	333*	333*	333*	333*
0.039µF		393*	393*	393*	393*	393*
0.047µF		473*	473*	473*	473*	473*
0.056µF		563*	563*	563*	563*	563*
0.068µF		683*	683*	683*	683*	683*
0.082µF		823*	823*	823*	823*	823*
0.1µF		104*	104*	104*	104*	104*
0.12µF		124*	124*	124*	124*	124*
0.15µF		154*	154*	154*	154*	154*
0.18µF		184*	184*	184*	184	184
0.22µF		224*	224*	224*	224	224
0.27µF		274*	274*	274*	274	274
0.33µF		334*	334*	334*	334	334
0.39µF		394*	394*	394*	394	394
0.47µF		474*	474*	474	474	474
0.56µF		564*	564*	564	564	564
0.68µF		684*	684*	684	684	684
0.82µF		824*	824*	824	824	824
1.0µF		105*	105*	105	105	105
1.2µF		125*	125*	125	125	125
1.5µF	155*	155*				
1.8µF	185*	185*				
2.2µF	225*	225*				
Rated Voltage (VDC)		25	50	100	200	250
Voltage Code		3	5	1	2	A

* Capacitor is supplied with a "Shoulder-Bend" lead configuration in Style/Size C330 and C331.

Bold text denotes only available on K and M tolerances.

Table 1E – C34X Style/Size, Capacitance Range Waterfall

C340, C346 Style/Size (0.200" Lead Spacing)						
Rated Voltage (VDC)		25	50	100	200	250
Voltage Code		3	5	1	2	A
Capacitance	Capacitance Tolerance	Capacitance Code (Available Capacitance)				
0.068μF	J = ±5% K = ±10% M = ±20%	683*	683*	683*	683*	683*
0.082μF		823*	823*	823*	823*	823*
0.1μF		104*	104*	104*	104*	104*
0.12μF		124*	124*	124*	124*	124*
0.15μF		154*	154*	154*	154*	154*
0.18μF		184*	184*	184*	184	184
0.22μF		224*	224*	224*	224	224
0.27μF		274*	274*	274*	274	274
0.33μF		334*	334*	334*	334	334
0.39μF		394*	394*	394*	394	394
0.47μF		474*	474*	474	474	474
0.56μF		564*	564*	564	564	564
0.68μF		684*	684*	684	684	684
0.82μF		824*	824*	824	824	824
1.0μF		105*	105*	105	105	105
1.2μF		125*	125*	125	125	125
1.5μF		155*	155*	155		
1.8μF		185*	185*	185		
2.2μF		225*	225*	225		
2.7μF		275	275			
3.3μF	335	335				
3.9μF	395	395				
4.7μF	475	475				
5.6μF	565	565				
6.8μF	685	685				
8.2μF	825	825				
10μF	106	106				
Rated Voltage (VDC)		25	50	100	200	250
Voltage Code		3	5	1	2	A

* Capacitor is supplied with a "Shoulder-Bend" lead configuration in Style/Size C340.

Bold text denotes only available on K and M tolerances.

Table 1F – C35X Style/Size, Capacitance Range Waterfall

C350, C356 Style/Size (0.400" Lead Spacing)						
Rated Voltage (VDC)		25	50	100	200	250
Voltage Code		3	5	1	2	A
Capacitance	Capacitance Tolerance	Capacitance Code (Available Capacitance)				
0.18µF	J = ±5% K = ±10% M = ±20%	184	184	184	184	184
0.22µF		224	224	224	224	224
0.27µF		274	274	274	274	274
0.33µF		334	334	334	334	334
0.39µF		394	394	394	394	394
0.47µF		474	474	474	474	474
0.56µF		564	564	564	564	564
0.68µF		684	684	684	684	684
0.82µF		824	824	824	824	824
1.0µF		105	105	105	105	105
1.2µF		125	125	125	125	125
1.5µF		155	155			
1.8µF		185	185			
2.2µF		225	225			
2.7µF		275	275			
3.3µF		335	335			
3.9µF		395	395			
4.7µF		475	475			
5.6µF		565	565			
6.8µF		685	685			
8.2µF	825	825				
10µF	106	106				
Rated Voltage (VDC)		25	50	100	200	250
Voltage Code		3	5	1	2	A

Soldering Process

Recommended Soldering Methods:

- Solder Wave
- Hand Soldering (Manual)

Recommended Soldering Profile:

- Optimum Wave Solder Profile

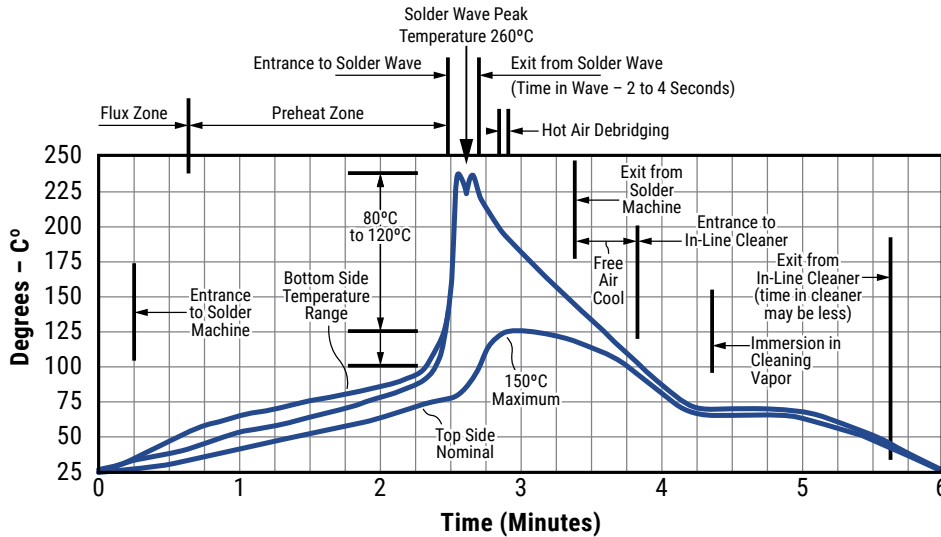

Mounting

All encased capacitors will pass the Resistance to Soldering Heat of MIL-STD-202, Method 210, Condition C. This test simulates wave solder topside board mount product. This demonstration of resistance to solder heat is in accordance with what is believed to be the industry standard. More severe treatment must be considered reflective of an improper soldering process.

The above figure is a recommended solder wave profile for both axial and radial leaded ceramic capacitors.

- Hand Soldering (Manual)

with Pre-heating

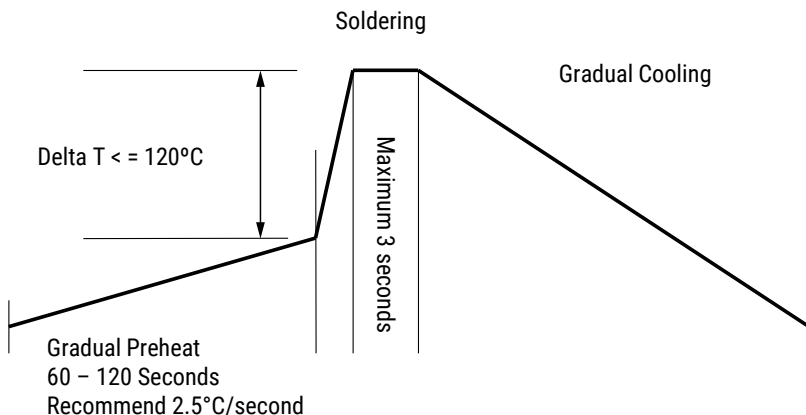

Table 2 – Performance & Reliability: Test Methods and Conditions

Stress	Reference	Test or Inspection Method
Solderability	J-STD-002	Magnification 50X. Conditions: a) Method A, at 235°C, Category 3
Temperature Cycling	JESD22 Method JA-104	5 cycles (-55°C to +125°C), measurement at 24 hours +/-4 hours after test conclusion.
Biased Humidity	MIL-STD-202 Method 103	Load humidity, 1,000 hours 85°C/85%RH and rated voltage. Add 100 K ohm resistor. Measurement at 24 hours +/-4 hours after test conclusion.
		Low volt humidity, 1,000 hours 85°C/85%RH and 1.5 V. Add 100 K ohm resistor. Measurement at 24 hours +/-4 hours after test conclusion.
Moisture Resistance	MIL-STD-202 Method 106	t = 24 hours/cycle. Steps 7a & 7b not required. Unpowered. Measurement at 24 hours +/-4 hours after test conclusion.
Thermal Shock	MIL-STD-202 Method 107	-55°C to +125°C. Note: Number of cycles required – 300. Maximum transfer time – 20 seconds. Dwell time – 15 minutes. Air – Air.
High Temperature Life	MIL-STD-202 Method 108/EIA-198	1,000 hours at 125°C (85°C for Z5U) with 1 X rated voltage applied.
Storage Life	MIL-STD-202 Method 108	125°C, 0 VDC for 1,000 hours.
Vibration	MIL-STD-202 Method 204	5 g for 20 minutes, 12 cycles each of 3 orientations. Note: Use 8"X5" PCB .031" thick 7 secure points on one long side and 2 secure points at corners of opposite sides. Parts mounted within 2" from any secure point. Test from 10-2000 Hz.
Resistance to Soldering Heat	MIL-STD-202 Method 210	Condition B. No preheat of samples. Note: single wave solder – procedure 2.
Terminal Strength	MIL-STD-202 Method 211	Conditions A (454g), Condition C (227g)
Mechanical Shock	MIL-STD-202 Method 213	Figure 1 of Method 213, Condition C.
Resistance to Solvents	MIL-STD-202 Method 215	Add aqueous wash chemical – OKEM Clean or equivalent.

Storage & Handling

The un-mounted storage life of a leaded ceramic capacitor is dependent upon storage and atmospheric conditions as well as packaging materials. While the ceramic chips enveloped under the epoxy coating themselves are quite robust in most environments, solderability of the wire lead on the final epoxy-coated product will be degraded by exposure to high temperatures, high humidity, corrosive atmospheres, and long term storage. In addition, packaging materials will be degraded by high temperature and exposure to direct sunlight – reels may soften or warp, and tape peel force may increase.

KEMET recommends storing the un-mounted capacitors in their original packaging, in a location away from direct sunlight, and where the temperature and relative humidity do not exceed 40 degrees centigrade and 70% respectively. For optimum solderability, capacitor stock should be used promptly, preferably within 18 months of receipt. For applications requiring pre-tinning of components, storage life may be extended if solderability is verified. Before cleaning, bonding or molding these devices, it is important to verify that your process does not affect product quality and performance. KEMET recommends testing and evaluating the performance of a cleaned, bonded or molded product prior to implementing and/or qualifying any of these processes.

Construction

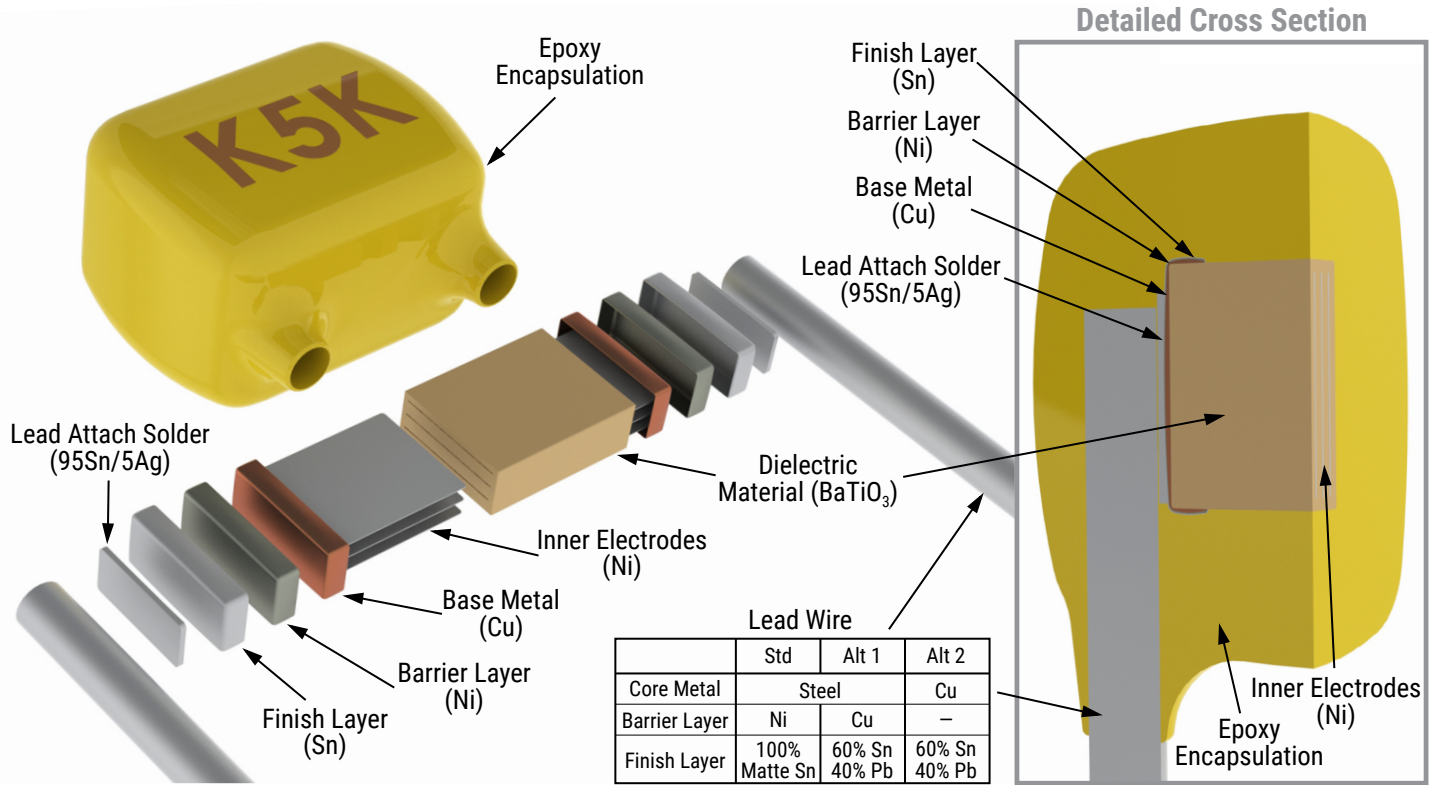

Marking

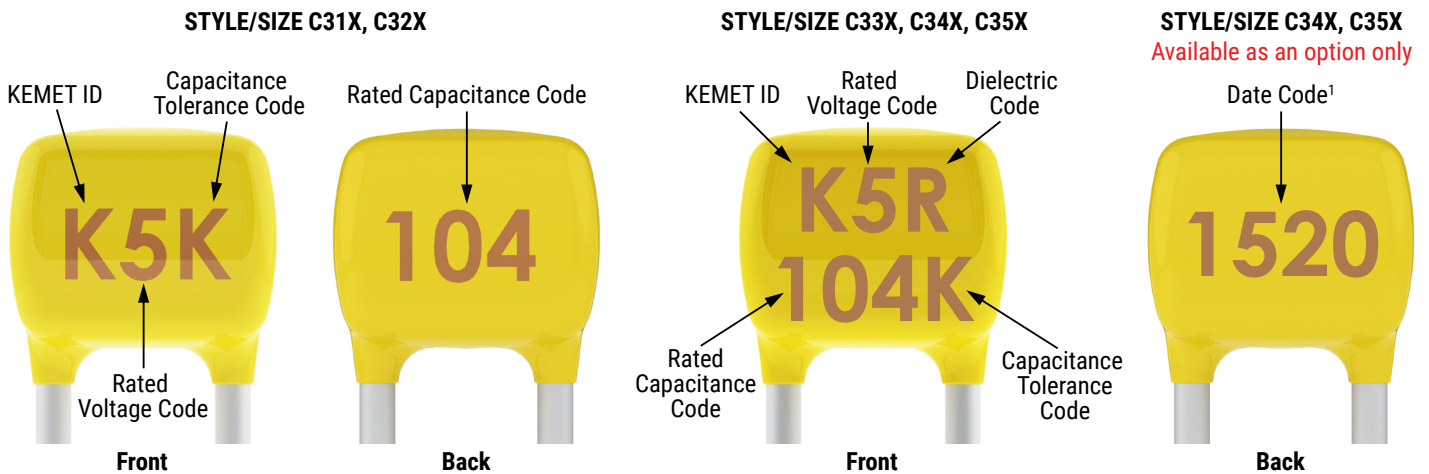

¹ To properly request the inclusion of the date code in the marking information provided on the component, ordering code C-SPEC 9207 must be added to the end of the ordering code.

Date Code	
15	20
Manufacturing Year: 15 = 2015	Manufacturing Week: 20 = Week 20 (of mfg. calendar year)

Packaging Quantities

Style/ Size	Standard Bulk Quantity	Ammo Pack Quantity Maximum	Reel Quantity Maximum (12" Reel)
315	500/Bag	2500	2500
316			
317			
318			
320			
321			
322		2500	2500
323			
324			
325			
326			
327			
328	250/Bag	1500	1500
330		N/A	N/A
331		1500	
333		1500	
335		1500	
336		1500	
340	100/Bag	1000	1000
346	50/Bag	N/A	500
350			
356			

Tape & Reel Packaging Information

KEMET offers standard reeling of Molded and Conformally Coated Radial Leaded Capacitors in accordance with EIA standard 468. Parts are taped to a tagboard carrier strip, and wound on a reel as shown in Figure 1. Kraft paper interleaving is inserted between the layers of capacitors on the reel. Ammopack is also available, with the same lead tape configuration and package quantities.

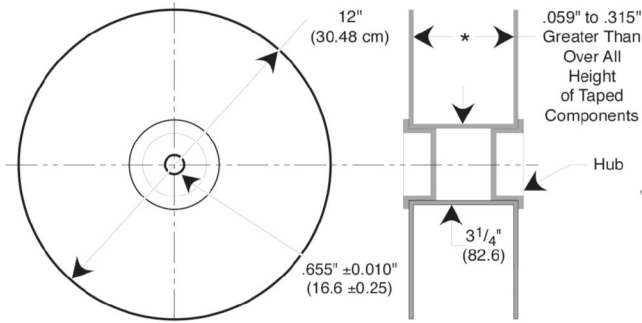

Figure 3: Standard Reel

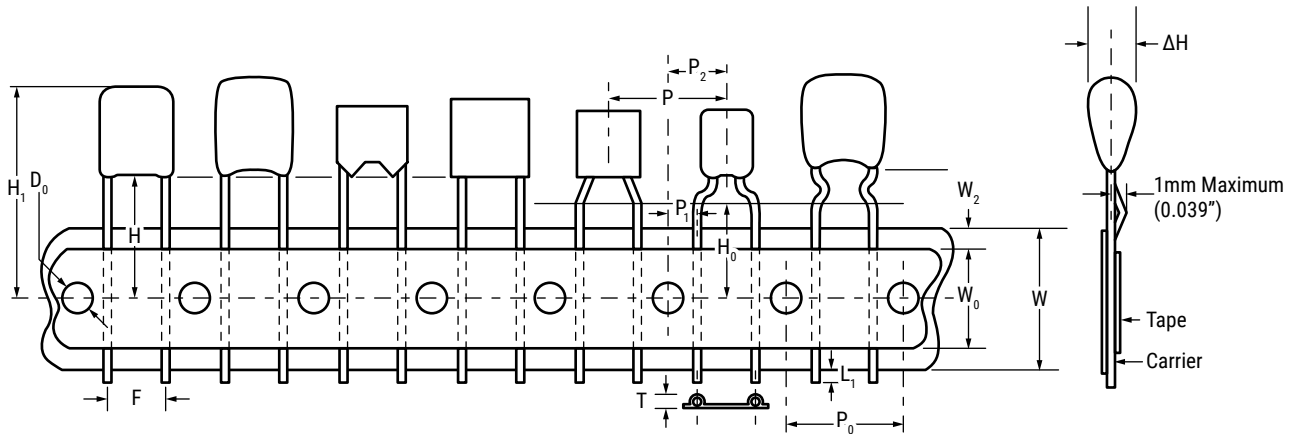
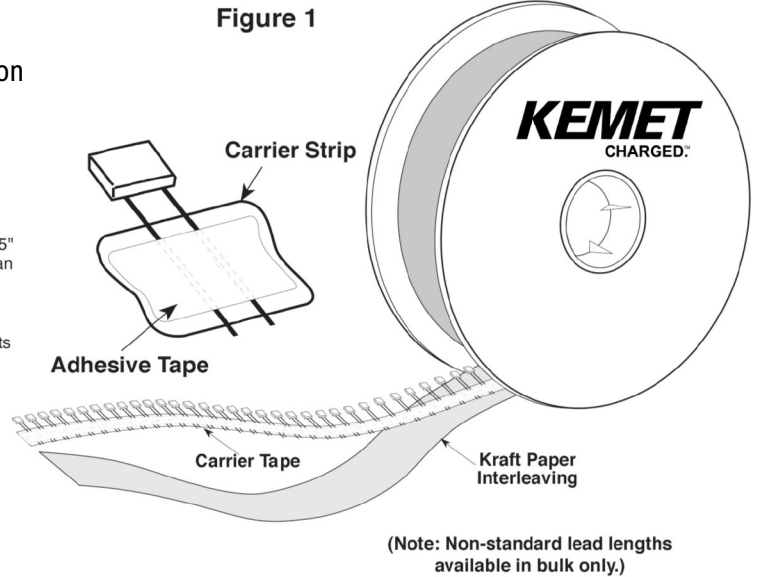

Figure 2: Lead Tape Configuration (See Table Below)

Ceramic Radial Tape and Reel Dimensions

Metric will govern

Constant Dimensions – Millimeters (Inches)								
D_0 ±0.2 (0.008)	P_0 ±0.3 (0.012)	ΔH ±0.2 (0.008)	L_1 Maximum	t ±0.2 (0.008)	T Maximum	W +1.0/-0.5 (+0.039/-0.020)	W_0 Minimum	W_2 Maximum
4.00 (0.157)	12.7 (0.500)	4.0 (0.157)	1.0 (0.039)	0.7 (0.051)	1.5 (0.059)	18.0 (0.709)	5.0 (0.197)	3.0 (0.118)

Ceramic Radial Tape and Reel Dimensions cont.

Metric will govern

Variable Dimensions – Millimeters (Inches)							
F ± 0.78 (0.030) ¹	P ₁ ± 0.30 (0.012) ¹	P ± 0.3 (0.012)	P ₂ ± 1.3 (0.051)	H		H ₀	
				Straight Lead Configuration		Formed Lead Configuration ²	
				Packaging C-Spec ³			
				7301/7305	7303/7317	7301/7305	7303/7317
2.54 (0.100)	5.08 (0.200)	12.7 (0.500)	6.35 (0.250)	16.0 \pm 0.5 (0.630 \pm 0.020)	18.0 (0.709) Minimum	16.0 \pm 0.5 (0.630 \pm 0.020)	18.0 (0.709) Minimum
4.32 (0.170)	3.89 (0.153)	12.7 (0.500)	6.35 (0.250)				
5.08 (0.200)	3.81 (0.150)	12.7 (0.500)	6.35 (0.250)				
5.59 (0.220)	3.25 (0.128)	12.7 (0.500)	6.35 (0.250)				
6.98 (0.275)	2.54 (0.100)	12.7 (0.500)	6.35 (0.250)				
7.62 (0.300)	2.24 (0.088)	12.7 (0.500)	6.35 (0.250)				
9.52 (0.375)	7.62 (0.300)	12.7 (0.500)	6.35 (0.250)				
10.16 (0.400)	7.34 (0.290)	25.4 (1.000)	N/A				
12.06 (0.475)	6.35 (0.250)	25.4 (1.000)	N/A				
14.60 (0.575)	5.08 (0.200)	25.4 (1.000)	N/A				
17.14 (0.675)	3.81 (0.15)	25.4 (1.000)	N/A				

¹ Measured at the egress from the carrier tape, on the component side.

² Formed lead configuration includes: "shoulder bend", "inside kink", "outside kink", and "snap-in". For more information regarding available lead configurations see "Dimensions" section of this document.

³ The "Packaging C-Spec" is a 4 digit code which identifies the packaging type, lead length and/or lead material. When ordering, the proper code must be included in the 15th through 18th character positions of the ordering code. See "Ordering Information" section of this document for further details.

Symbol Reference Table	
D ₀	Sprocket Hole Diameter
P ₀	Sprocket Hole Pitch
P	Component Pitch
F	Lead Spacing
P ₁	Sprocket Hole Center to Lead Center
P ₂	Sprocket Hole Center To Component Center
H	Height to Seating Plane (Straight Leads Only)
H ₀	Height to Seating Plane (Formed Leads Only)
H ₁	Component Height Above Tape Center
ΔH	Component Alignment
L ₁	Lead Protrusion
t	Composite Tape Thickness
W	Carrier Tape Width
W ₀	Hold-Down Tape Width
W ₂	Hold-Down Tape Location

KEMET Electronics Corporation Sales Offices

For a complete list of our global sales offices, please visit www.kemet.com/sales.

Disclaimer

YAGEO Corporation and its affiliates do not recommend the use of commercial or automotive grade products for high reliability applications or manned space flight.

All product specifications, statements, information and data (collectively, the "Information") in this datasheet are subject to change. The customer is responsible for checking and verifying the extent to which the Information contained in this publication is applicable to an order at the time the order is placed. All Information given herein is believed to be accurate and reliable, but it is presented without guarantee, warranty, or responsibility of any kind, expressed or implied.

Statements of suitability for certain applications are based on KEMET Electronics Corporation's ("KEMET") knowledge of typical operating conditions for such applications, but are not intended to constitute – and KEMET specifically disclaims – any warranty concerning suitability for a specific customer application or use. The Information is intended for use only by customers who have the requisite experience and capability to determine the correct products for their application. Any technical advice inferred from this Information or otherwise provided by KEMET with reference to the use of KEMET's products is given gratis, and KEMET assumes no obligation or liability for the advice given or results obtained.

Although KEMET designs and manufactures its products to the most stringent quality and safety standards, given the current state of the art, isolated component failures may still occur. Accordingly, customer applications which require a high degree of reliability or safety should employ suitable designs or other safeguards (such as installation of protective circuitry or redundancies) in order to ensure that the failure of an electrical component does not result in a risk of personal injury or property damage.

Although all product-related warnings, cautions and notes must be observed, the customer should not assume that all safety measures are indicated or that other measures may not be required.

KEMET is a registered trademark of KEMET Electronics Corporation.

Looking for pricing, stock, or lifecycle information?

Click below to explore more details on WIN SOURCE:

 [View C317C103K5R5TA7301 on WIN SOURCE](#)

 [Kemet Information](#)

Optimize Your Supply Chain with WIN SOURCE Solutions

-  Global Sourcing Solution
-  Obsolete Management
-  Cost Control Management
-  Shortage Management
-  Alternative Solution
-  Excess Inventory Management