



**THE DATASHEET OF  
BZA408B,125**



## Important notice

Dear Customer,

On 7 February 2017 the former NXP Standard Product business became a new company with the tradename **Nexperia**. Nexperia is an industry leading supplier of Discrete, Logic and PowerMOS semiconductors with its focus on the automotive, industrial, computing, consumer and wearable application markets

In data sheets and application notes which still contain NXP or Philips Semiconductors references, use the references to Nexperia, as shown below.

Instead of <http://www.nxp.com>, <http://www.philips.com/> or <http://www.semiconductors.philips.com/>, use <http://www.nexperia.com>

Instead of [sales.addresses@www.nxp.com](mailto:sales.addresses@www.nxp.com) or [sales.addresses@www.semiconductors.philips.com](mailto:sales.addresses@www.semiconductors.philips.com), use [salesaddresses@nexperia.com](mailto:salesaddresses@nexperia.com) (email)

Replace the copyright notice at the bottom of each page or elsewhere in the document, depending on the version, as shown below:

- © NXP N.V. (year). All rights reserved or © Koninklijke Philips Electronics N.V. (year). All rights reserved

Should be replaced with:

- © **Nexperia B.V. (year). All rights reserved.**

If you have any questions related to the data sheet, please contact our nearest sales office via e-mail or telephone (details via [salesaddresses@nexperia.com](mailto:salesaddresses@nexperia.com)). Thank you for your cooperation and understanding,

Kind regards,

Team Nexperia

# DATA SHEET

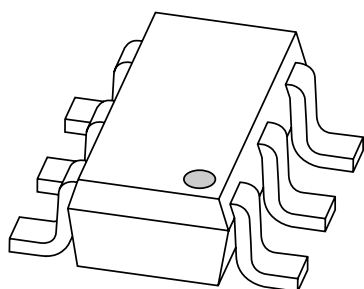

## **BZA408B**

Quadruple bidirectional ESD  
transient voltage suppressor

Product data sheet  
Supersedes data of 1998 Jun 05

1998 Oct 15

# Quadruple bidirectional ESD transient voltage suppressor

**BZA408B**

## FEATURES

- ESD rating >15 kV, according to IEC1000-4-2
- SOT457 surface mount package
- Non-clamping range: -5 V to +5 V
- Channel separation: >70 dB
- Low reverse current: <100 nA
- Low diode capacitance: <75 pF.

## APPLICATIONS

- Protection of equipment, connected to data and transmission lines, against voltage surges caused by electrostatic discharge e.g:
  - Computers and peripherals
  - Audio and video equipment
  - Communication systems
  - Medical equipment
  - Portable electronics.

## DESCRIPTION

4-bit wide monolithic bidirectional ESD transient voltage suppressor in a six lead SOT457 (SC-74) package.

## PINNING

PIN	DESCRIPTION
1	cathode 1
2, 5	ground
3	cathode 2
4	cathode 3
6	cathode 4

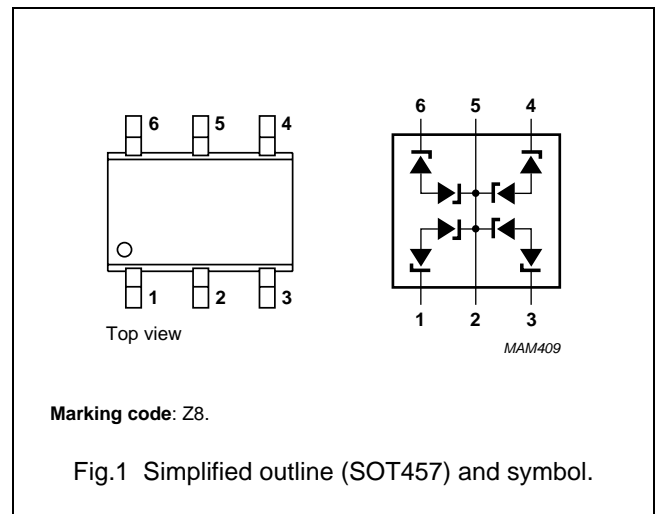

## LIMITING VALUES

In accordance with the Absolute Maximum Rating System (IEC 134).

SYMBOL	PARAMETER	CONDITIONS	MIN.	MAX.	UNIT
<b>Per diode</b> (pin 2 and / or 5 connected to ground)					
$I_{ZSM}$	non-repetitive peak reverse current	$t_p = 1$ ms; square pulse; see Fig.2	-	2	A
$P_{ZSM}$	non-repetitive peak power	$t_p = 1$ ms; square pulse	-	20	W
$T_{stg}$	storage temperature		-65	+150	°C
$T_j$	junction temperature		-65	+150	°C

# Quadruple bidirectional ESD transient voltage suppressor

BZA408B

## THERMAL CHARACTERISTICS

SYMBOL	PARAMETER	CONDITIONS	VALUE	UNIT
$R_{th\ j-s}$	thermal resistance from junction to soldering point	one or more diodes loaded	340	K/W

## ELECTRICAL CHARACTERISTICS

$T_j = 25\text{ }^\circ\text{C}$  unless otherwise specified.

SYMBOL	PARAMETER	CONDITIONS	MIN.	MAX.	UNIT
<b>Per diode</b> (pin 2 and / or 5 connected to ground)					
$V_{RWM}$	working reverse voltage		–	5	V
$V_R$	reverse voltage	$I_{test} = 5\text{ mA}$	5.5	–	V
$V_{ZSM}$	non-repetitive peak reverse voltage	$t_p = 1\text{ ms}; I_{ZSM} = 2\text{ A}$	–	10	V
$I_R$	reverse current	$V_R = V_{RWM}$	–	100	nA
$C_d$	diode capacitance	see Fig.3			
		$V_R = 0; f = 1\text{ MHz}$	–	75	pF
		$V_R = 5\text{ V}; f = 1\text{ MHz}$	–	55	pF
$\alpha_{ch\ (p\ to\ p)}$	pin to pin channel separation	note 1; see Fig.4	70	–	dB

### Note

- $\alpha_{ch\ (p\ to\ p)}$  is measured as follows: a  $-7\text{ dBs}$  sinewave of 400 Hz is connected to e.g. pin 6 and a  $-7\text{ dBs}$  sinewave of 1 kHz to pin 1. The 1 kHz signal of pin 1 is measured on pin 6 by means of a spectrum analyser with an input impedance of  $1\text{ M}\Omega$ . So  $\alpha_{ch\ (p\ to\ p)}$  equals the 1 kHz level on pin 1 minus the 1 kHz level on pin 6. For the 400 Hz signal the same measurement is done in the opposite way.

# Quadruple bidirectional ESD transient voltage suppressor

## BZA408B

### GRAPHICAL DATA

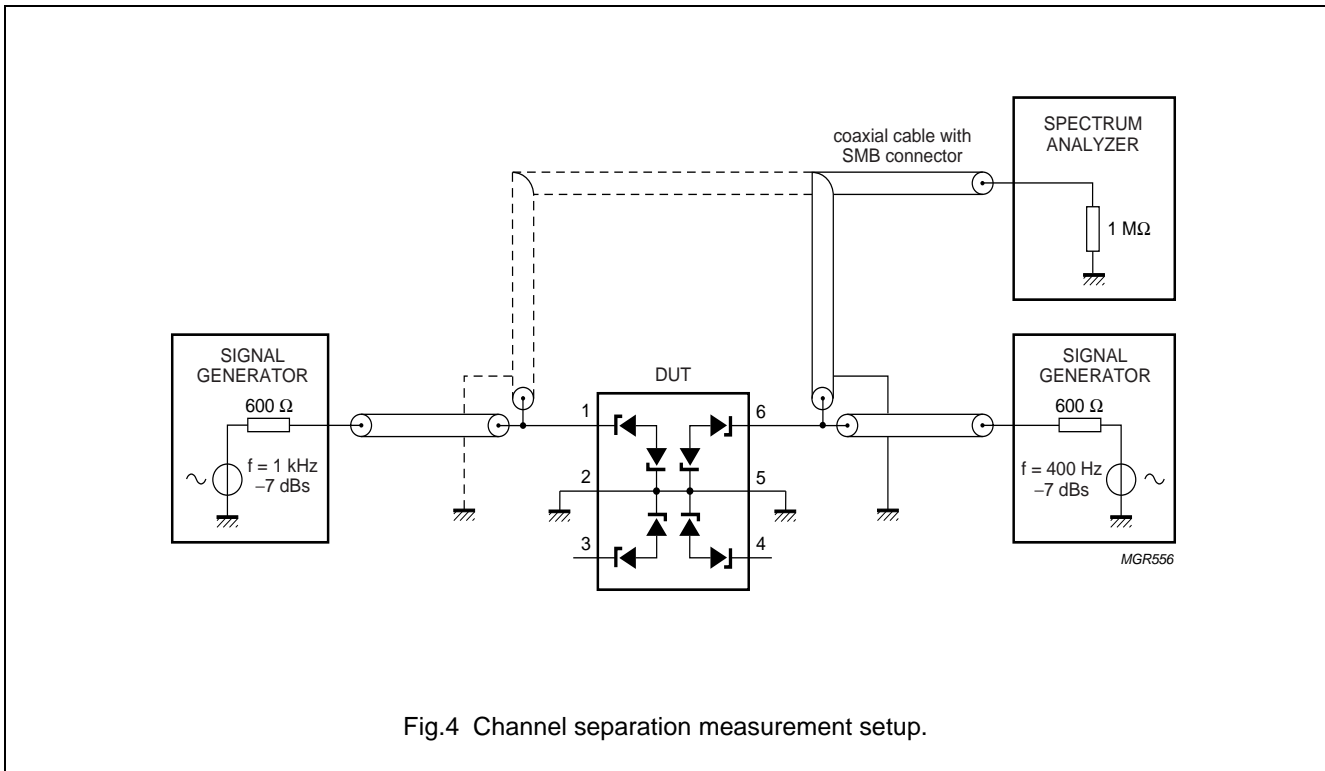
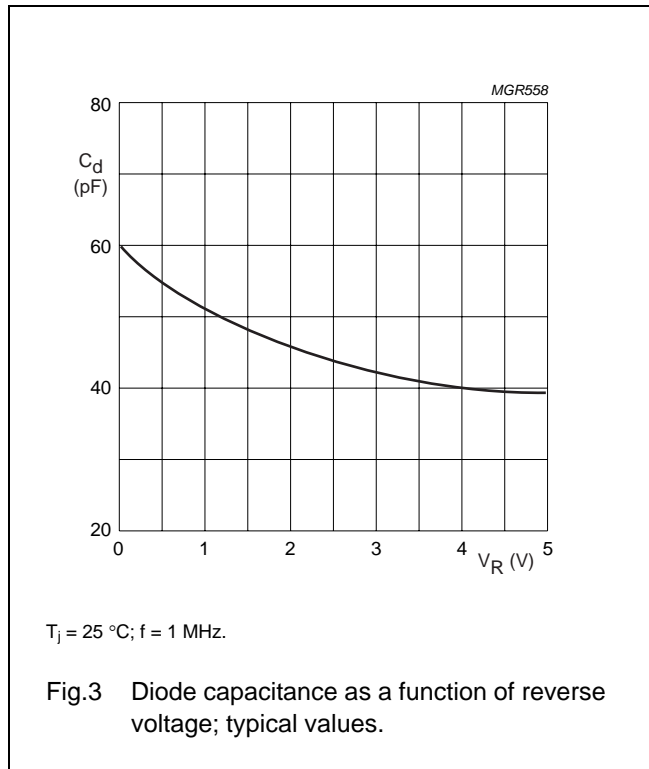
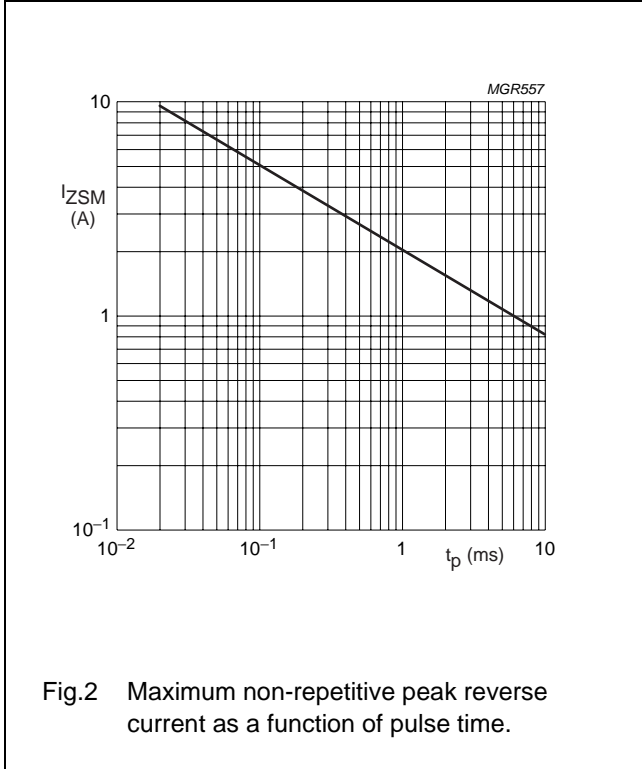

# Quadruple bidirectional ESD transient voltage suppressor

## BZA408B

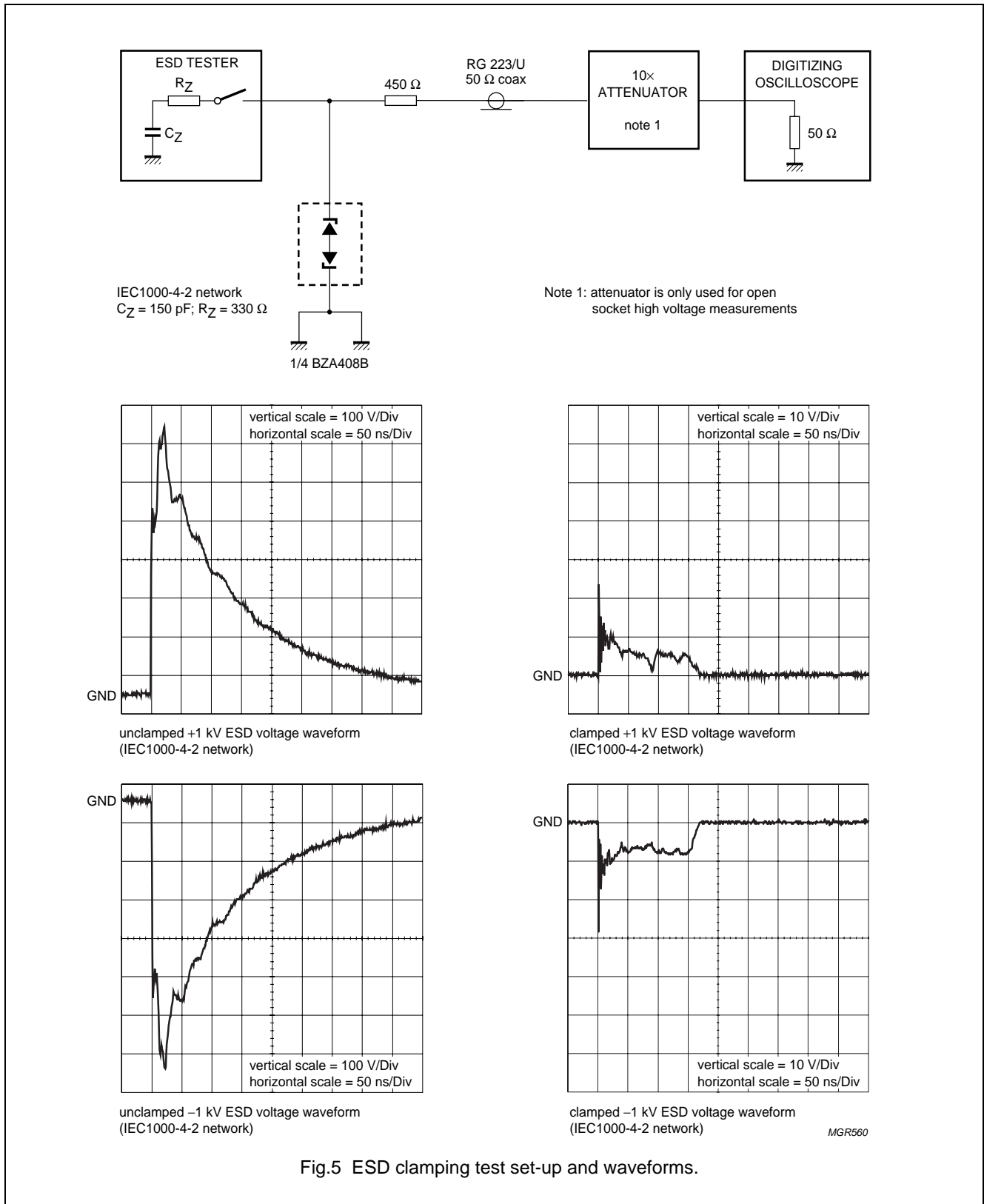

Fig.5 ESD clamping test set-up and waveforms.

# Quadruple bidirectional ESD transient voltage suppressor

## BZA408B

### APPLICATION INFORMATION

#### Typical bidirectional application

A quadruple bidirectional transient suppressor in a SOT457 package makes it possible to protect four separate lines using only one package. One simplified example is shown in Fig.6.

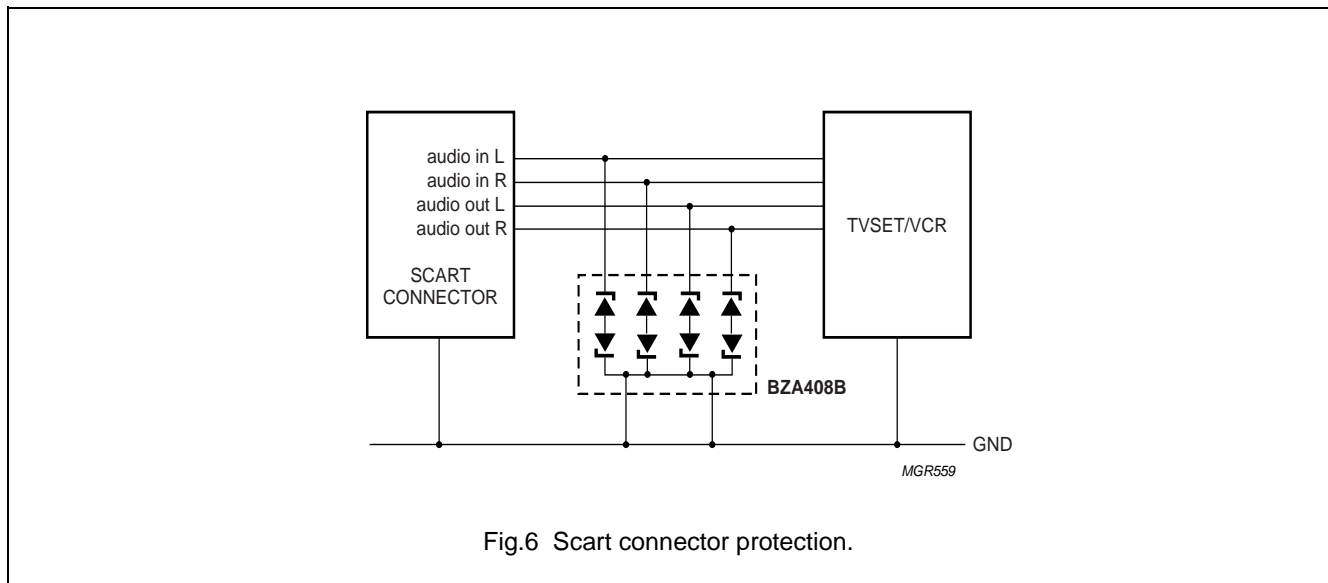

#### Device placement and printed-circuit board layout

Circuit board layout is of extreme importance in the suppression of transients. The clamping voltage of the BZA408B is determined by the peak transient current and the rate of rise of that current ( $di/dt$ ). Since parasitic inductances can further add to the clamping voltage ( $V = L di/dt$ ) the series conductor lengths on the printed-circuit board should be kept to a minimum. This includes the lead length of the suppression element.

In addition to minimizing conductor length the following printed-circuit board layout guidelines are recommended:

1. Place the suppression element close to the input terminals or connectors.
2. Keep parallel signal paths to a minimum.
3. Avoid running protection conductors in parallel with unprotected conductors.
4. Minimize all printed-circuit board loop areas including power and ground loops.
5. Minimize the length of the transient return path to ground.
6. Avoid using shared transient return paths to a common ground point.

Quadruple bidirectional ESD transient voltage suppressor

BZA408B

PACKAGE OUTLINE

Plastic surface mounted package; 6 leads

SOT457

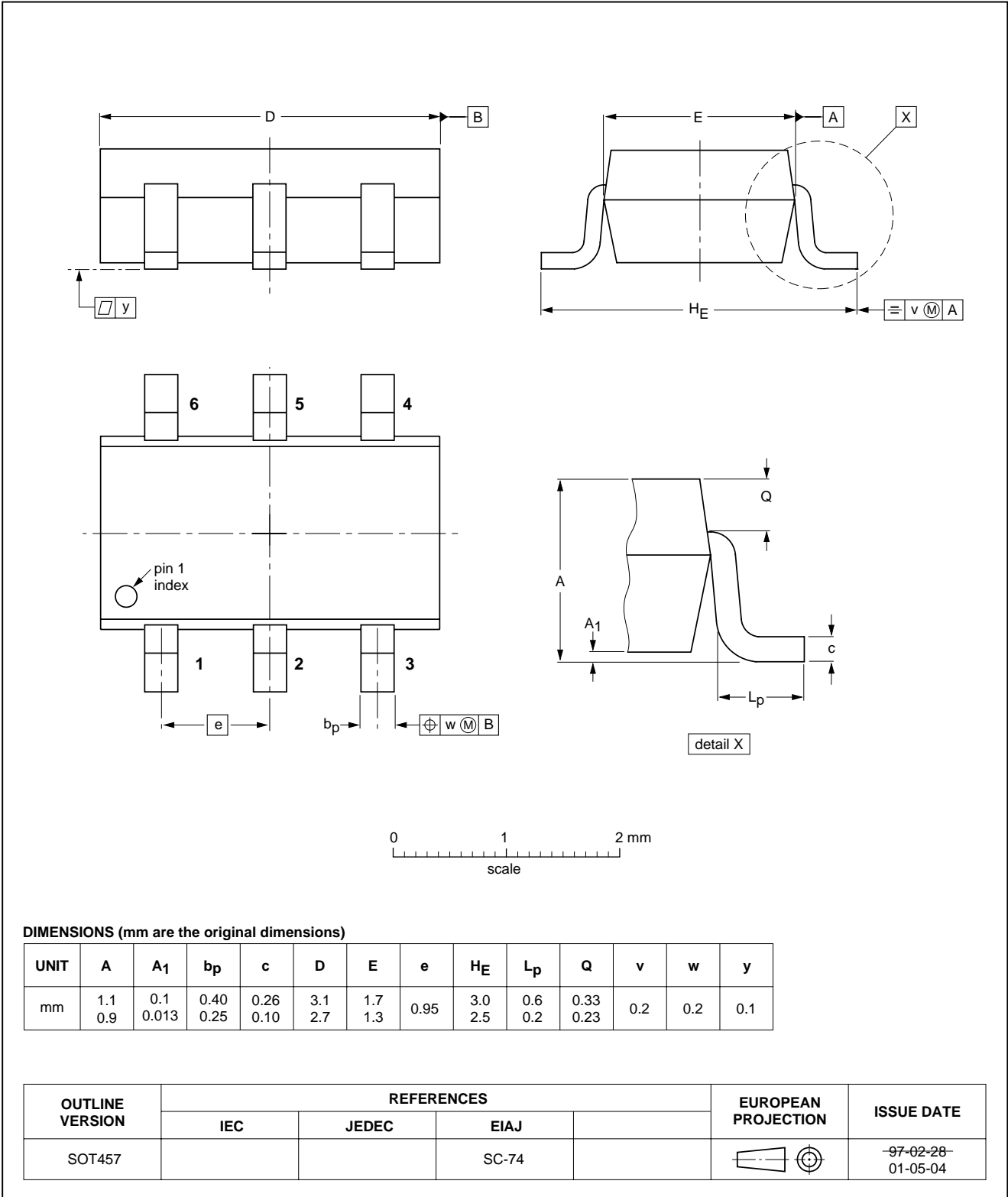

# Quadruple bidirectional ESD transient voltage suppressor

## BZA408B

### DATA SHEET STATUS

DOCUMENT STATUS <sup>(1)</sup>	PRODUCT STATUS <sup>(2)</sup>	DEFINITION
Objective data sheet	Development	This document contains data from the objective specification for product development.
Preliminary data sheet	Qualification	This document contains data from the preliminary specification.
Product data sheet	Production	This document contains the product specification.

### Notes

1. Please consult the most recently issued document before initiating or completing a design.
2. The product status of device(s) described in this document may have changed since this document was published and may differ in case of multiple devices. The latest product status information is available on the Internet at URL <http://www.nxp.com>.

### DISCLAIMERS

**General** — Information in this document is believed to be accurate and reliable. However, NXP Semiconductors does not give any representations or warranties, expressed or implied, as to the accuracy or completeness of such information and shall have no liability for the consequences of use of such information.

**Right to make changes** — NXP Semiconductors reserves the right to make changes to information published in this document, including without limitation specifications and product descriptions, at any time and without notice. This document supersedes and replaces all information supplied prior to the publication hereof.

**Suitability for use** — NXP Semiconductors products are not designed, authorized or warranted to be suitable for use in medical, military, aircraft, space or life support equipment, nor in applications where failure or malfunction of an NXP Semiconductors product can reasonably be expected to result in personal injury, death or severe property or environmental damage. NXP Semiconductors accepts no liability for inclusion and/or use of NXP Semiconductors products in such equipment or applications and therefore such inclusion and/or use is at the customer's own risk.

**Applications** — Applications that are described herein for any of these products are for illustrative purposes only. NXP Semiconductors makes no representation or warranty that such applications will be suitable for the specified use without further testing or modification.

**Limiting values** — Stress above one or more limiting values (as defined in the Absolute Maximum Ratings System of IEC 60134) may cause permanent damage to the device. Limiting values are stress ratings only and operation of the device at these or any other conditions

above those given in the Characteristics sections of this document is not implied. Exposure to limiting values for extended periods may affect device reliability.

**Terms and conditions of sale** — NXP Semiconductors products are sold subject to the general terms and conditions of commercial sale, as published at <http://www.nxp.com/profile/terms>, including those pertaining to warranty, intellectual property rights infringement and limitation of liability, unless explicitly otherwise agreed to in writing by NXP Semiconductors. In case of any inconsistency or conflict between information in this document and such terms and conditions, the latter will prevail.

**No offer to sell or license** — Nothing in this document may be interpreted or construed as an offer to sell products that is open for acceptance or the grant, conveyance or implication of any license under any copyrights, patents or other industrial or intellectual property rights.

**Export control** — This document as well as the item(s) described herein may be subject to export control regulations. Export might require a prior authorization from national authorities.

**Quick reference data** — The Quick reference data is an extract of the product data given in the Limiting values and Characteristics sections of this document, and as such is not complete, exhaustive or legally binding.

# ***NXP Semiconductors***

## **Customer notification**

This data sheet was changed to reflect the new company name NXP Semiconductors, including new legal definitions and disclaimers. No changes were made to the technical content, except for package outline drawings which were updated to the latest version.

## **Contact information**

For additional information please visit: <http://www.nxp.com>

For sales offices addresses send e-mail to: [salesaddresses@nxp.com](mailto:salesaddresses@nxp.com)

© NXP B.V. 2009

All rights are reserved. Reproduction in whole or in part is prohibited without the prior written consent of the copyright owner.

The information presented in this document does not form part of any quotation or contract, is believed to be accurate and reliable and may be changed without notice. No liability will be accepted by the publisher for any consequence of its use. Publication thereof does not convey nor imply any license under patent- or other industrial or intellectual property rights.

Printed in The Netherlands

115104/00/02/pp9

Date of release: 1998 Oct 15

Document order number: 9397 750 04313



## Looking for pricing, stock, or lifecycle information?

Click below to explore more details on WIN SOURCE:

 [View BZA408B,125 on WIN SOURCE](#)

 [Nexperia USA Inc. Information](#)

## Optimize Your Supply Chain with WIN SOURCE Solutions

-  Global Sourcing Solution
-  Obsolete Management
-  Cost Control Management
-  Shortage Management
-  Alternative Solution
-  Excess Inventory Management