

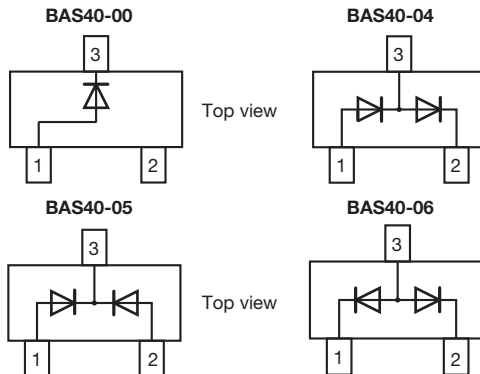

**THE DATASHEET OF
BAS40-04-E3-18**



Small Signal Schottky Diodes, Single and Dual



FEATURES

- These diodes feature very low turn-on voltage and fast switching
- These devices are protected by a PN junction guarding against excessive voltage, such as electrostatic discharges
- AEC-Q101 qualified available
- Base P/N-E3 - RoHS-compliant, commercial grade
- Base P/N-HE3 - RoHS-compliant, AEC-Q101 qualified
- Material categorization: for definitions of compliance please see www.vishay.com/doc?99912

RoHS
COMPLIANT

MECHANICAL DATA

Case: SOT-23

Weight: approx. 8.8 mg

Packaging codes/options:

 18/10K per 13" reel (8 mm tape), 10K/box
 08/3K per 7" reel (8 mm tape), 15K/box

DESIGN SUPPORT TOOLS click logo to get started

PARTS TABLE				
PART	ORDERING CODE	CIRCUIT CONFIGURATION	TYPE MARKING	REMARKS
BAS40-00	BAS40-00-E3-08 or BAS40-00-E3-18	Single	43	Tape and reel
	BAS40-00-HE3-08 or BAS40-00-HE3-18			
BAS40-04	BAS40-04-E3-08 or BAS40-04-E3-18	Dual serial	44	
	BAS40-04-HE3-08 or BAS40-04-HE3-18			
BAS40-05	BAS40-05-E3-08 or BAS40-05-E3-18	Common cathode	45	
	BAS40-05-HE3-08 or BAS40-05-HE3-18			
BAS40-06	BAS40-06-E3-08 or BAS40-06-E3-18	Common anode	46	
	BAS40-06-HE3-08 or BAS40-06-HE3-18			

ABSOLUTE MAXIMUM RATINGS ($T_{amb} = 25\text{ }^{\circ}\text{C}$, unless otherwise specified)				
PARAMETER	TEST CONDITION	SYMBOL	VALUE	UNIT
Repetitive peak reverse voltage		$V_{RRM} = V_{RWM} = V_R$	40	V
Forward continuous current ⁽¹⁾		I_F	200	mA
Surge forward current ⁽¹⁾	$t_p < 1\text{ s}$	I_{FSM}	600	mA
Power dissipation ⁽¹⁾		P_{tot}	200	mW

Note
⁽¹⁾ Device on fiberglass substrate, see layout on next page



THERMAL CHARACTERISTICS (T _{amb} = 25 °C, unless otherwise specified)				
PARAMETER	TEST CONDITION	SYMBOL	VALUE	UNIT
Thermal resistance junction to ambient air ⁽¹⁾		R _{thJA}	500	K/W
Junction temperature		T _j	125	°C
Storage temperature range		T _{stg}	-65 to +150	°C
Operating temperature range		T _{op}	-55 to +125	°C

Note

(1) Device on fiberglass substrate, see layout on next page

ELECTRICAL CHARACTERISTICS (T _{amb} = 25 °C, unless otherwise specified)						
PARAMETER	TEST CONDITION	SYMBOL	MIN.	TYP.	MAX.	UNIT
Reverse breakdown voltage	I _R = 10 μA (pulsed)	V _(BR)	40			V
Leakage current	V _R = 30 V	I _R		20	100	nA
Forward voltage	I _F = 1 mA	V _F			380	mV
Forward voltage ⁽¹⁾	I _F = 40 mA	V _F			1000	mV
Diode capacitance	V _R = 0 V, f = 1 MHz	C _D		4	5	pF
Reverse recovery time	I _F = I _R = 10 mA, i _R = 1 mA, R _L = 100 Ω	t _{rr}			5	ns

Note

(1) Pulse test t_p < 300 μs

LAYOUT FOR R_{thJA} TEST

Thickness:

Fiberglass 1.5 mm (0.059 inches)

Copper leads 0.3 mm (0.012 inches)

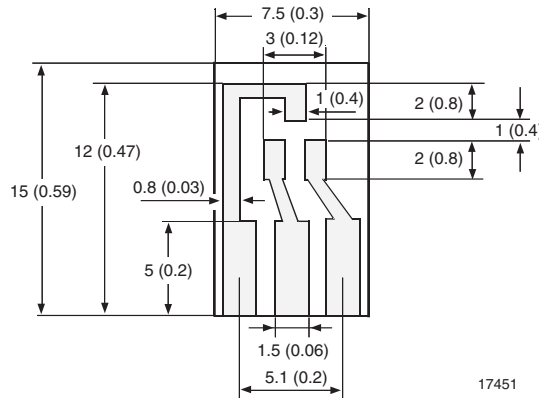



PACKAGE DIMENSIONS in millimeters (inches): **SOT-23**

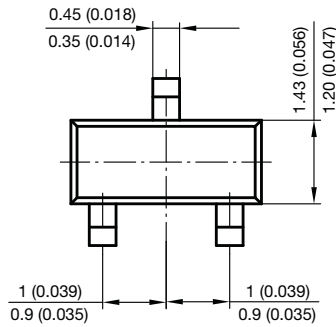
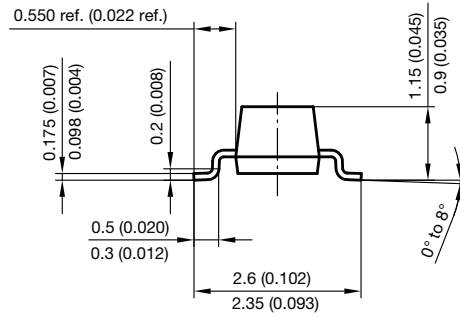
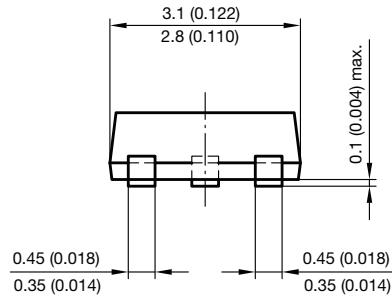

Foot print recommendation:

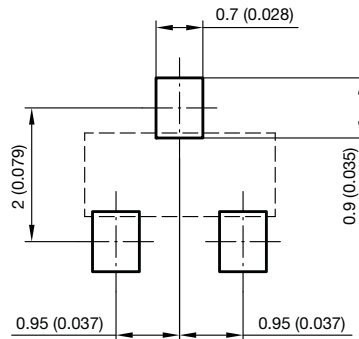

Document no.: 6.541-5014.01-4
Rev. 8 - Date: 23.Sept.2009
17418



Disclaimer

ALL PRODUCT, PRODUCT SPECIFICATIONS AND DATA ARE SUBJECT TO CHANGE WITHOUT NOTICE TO IMPROVE RELIABILITY, FUNCTION OR DESIGN OR OTHERWISE.

Vishay Intertechnology, Inc., its affiliates, agents, and employees, and all persons acting on its or their behalf (collectively, "Vishay"), disclaim any and all liability for any errors, inaccuracies or incompleteness contained in any datasheet or in any other disclosure relating to any product.

Vishay makes no warranty, representation or guarantee regarding the suitability of the products for any particular purpose or the continuing production of any product. To the maximum extent permitted by applicable law, Vishay disclaims (i) any and all liability arising out of the application or use of any product, (ii) any and all liability, including without limitation special, consequential or incidental damages, and (iii) any and all implied warranties, including warranties of fitness for particular purpose, non-infringement and merchantability.

Statements regarding the suitability of products for certain types of applications are based on Vishay's knowledge of typical requirements that are often placed on Vishay products in generic applications. Such statements are not binding statements about the suitability of products for a particular application. It is the customer's responsibility to validate that a particular product with the properties described in the product specification is suitable for use in a particular application. Parameters provided in datasheets and / or specifications may vary in different applications and performance may vary over time. All operating parameters, including typical parameters, must be validated for each customer application by the customer's technical experts. Product specifications do not expand or otherwise modify Vishay's terms and conditions of purchase, including but not limited to the warranty expressed therein.

Except as expressly indicated in writing, Vishay products are not designed for use in medical, life-saving, or life-sustaining applications or for any other application in which the failure of the Vishay product could result in personal injury or death. Customers using or selling Vishay products not expressly indicated for use in such applications do so at their own risk. Please contact authorized Vishay personnel to obtain written terms and conditions regarding products designed for such applications.

No license, express or implied, by estoppel or otherwise, to any intellectual property rights is granted by this document or by any conduct of Vishay. Product names and markings noted herein may be trademarks of their respective owners.

Looking for pricing, stock, or lifecycle information?

Click below to explore more details on WIN SOURCE:

 [View BAS40-04-E3-18 on WIN SOURCE](#)

 [Vishay Information](#)

Optimize Your Supply Chain with WIN SOURCE Solutions

-  Global Sourcing Solution
-  Obsolete Management
-  Cost Control Management
-  Shortage Management
-  Alternative Solution
-  Excess Inventory Management