



Power Splitter/Combiner TCP-2-122-75X+

75Ω 2 Way-0° 5 to 1250 MHz

FEATURES

- Operates over both upstream and downstream bands
- Low insertion, 0.8 dB typ.
- Excellent amplitude unbalance, 0.3 dB typ.
- Very good phase unbalance, 1.0 deg. typ.
- External resistor & capacitor required
- Aqueous washable
- Leads for excellent solderability
- Low cost



Generic photo used for illustration purposes only

CASE STYLE: DB1627

+RoHS Compliant

The +Suffix identifies RoHS Compliance. See our web site for RoHS Compliance methodologies and qualifications

APPLICATIONS

- DOCSIS® 3.1 Systems
- VHF/UHF
- CATV
- Cellular

ELECTRICAL SPECIFICATIONS AT 25°C

Parameter	Frequency (MHz)	Min.	Typ.	Max.	Unit
Frequency Range		5		1250	MHz
Insertion Loss, above 3.0 dB	5 - 50	—	0.5	0.7	dB
	50 - 1000	—	0.8	1.3	
	1000 - 1250	—	1.0	1.9	
Isolation	5 - 1000	19	25	—	dB
	1000 - 1250	17	23	—	
Phase Unbalance	5 - 1000	—	1.0	3	Degree
	1000 - 1250	—	2.0	5	
Amplitude Unbalance	5 - 1000	—	0.3	0.6	dB
	1000 - 1250	—	0.5	0.8	
VSWR (Port S)	5 - 1000	—	1.3	1.6	:1
	1000 - 1250	—	1.6	1.9	
VSWR (Port 1-2)	5 - 1000	—	1.3	1.8	
	1000 - 1250	—	1.6	1.9	

MAXIMUM RATINGS

Parameter	Ratings
Operating temperature	-40°C to 85°C
Storage temperature	-55°C to 100°C
RF Power Input (as splitter)	0.5 W max.

Permanent damage may occur if any of these limits are exceeded.

FUNCTIONAL SCHEMATIC

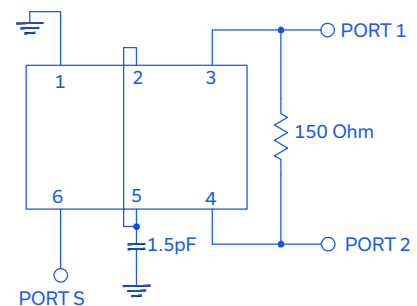



Power Splitter/Combiner **TCP-2-122-75X+**

PIN CONNECTIONS

SUM PORT	6
PORT 1	3
PORT 2	4
GROUND	1
CONNECT	2,5
EXT. RESISTOR 150Ω	3,4
EXT. CAPACITOR 1.5pF	2 OR 5 TO GND

PRODUCT MARKING: PB

DEMO BOARD MCL P/N: TB-124 SUGGESTED PCB LAYOUT (PL-002)

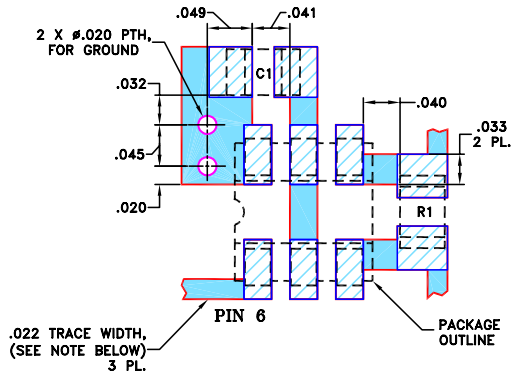

RESISTOR R1: 150 Ohm, 0805 SIZE
CAPACITOR C1: 1.5 pF, 0805 SIZE

- NOTES:
- TRACE WIDTH IS SHOWN FOR ROGERS R04350B WITH DIELECTRIC THICKNESS $0.030" \pm 0.002"$; COPPER: 1 OZ. EACH SIDE. FOR OTHER MATERIALS TRACE WIDTH MAY NEED TO BE MODIFIED.
 - BOTTOM SIDE OF THE PCB IS CONTINUOUS GROUND PLANE.
- DENOTES PCB COPPER LAYOUT WITH SMOBC (SOLDER MASK OVER BARE COPPER)
 - DENOTES COPPER LAND PATTERN FREE OF SOLDER MASK

OUTLINE DRAWING

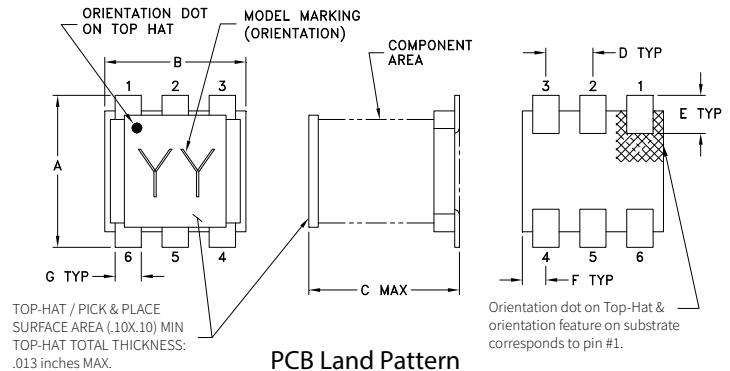

PCB Land Pattern

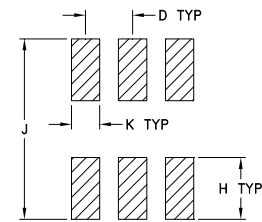

SUGGESTED LAYOUT
TOLERANCE TO BE WITHIN ± 0.02

OUTLINE DIMENSIONS (Inches/mm)

A	B	C	D	E	F
.160	.150	.160	.050	.040	.025
4.06	3.81	4.06	1.27	1.02	0.64
G	H	J	K		wt
.028	.065	.190	.030		grams
0.71	1.65	4.83	0.76		0.15

TAPE & REEL INFORMATION: F47



Power Splitter/Combiner **TCP-2-122-75X+**

TYPICAL PERFORMANCE DATA AT 25°C

Frequency (MHz)	Total Loss ¹ (dB)		Amplitude Unbalance (dB)	Isolation (dB)	Phase Unbalance (deg.)	VSWR (:1)		
	S-1	S-2				S	1	2
5	3.39	3.15	0.24	25.09	1.29	1.04	1.27	1.19
50	3.36	3.18	0.19	29.10	0.06	1.01	1.19	1.14
100	3.38	3.20	0.18	28.95	0.10	1.04	1.18	1.14
150	3.40	3.22	0.17	28.84	0.21	1.06	1.18	1.15
250	3.42	3.26	0.16	28.59	0.39	1.10	1.18	1.17
350	3.43	3.31	0.12	28.33	0.53	1.14	1.18	1.21
450	3.45	3.36	0.09	27.89	0.64	1.17	1.19	1.24
600	3.48	3.46	0.02	26.81	0.72	1.20	1.21	1.29
700	3.49	3.53	0.04	26.06	0.67	1.21	1.24	1.33
800	3.52	3.62	0.10	25.45	0.51	1.21	1.27	1.36
925	3.56	3.76	0.19	25.07	0.09	1.23	1.32	1.41
1025	3.62	3.88	0.27	25.11	0.42	1.25	1.36	1.45
1100	3.68	4.00	0.32	25.39	0.90	1.28	1.39	1.49
1150	3.73	4.09	0.36	25.61	1.30	1.30	1.41	1.52
1250	3.88	4.32	0.44	25.80	1.99	1.35	1.45	1.59

1. Total Loss = Insertion Loss + 3dB splitter loss.

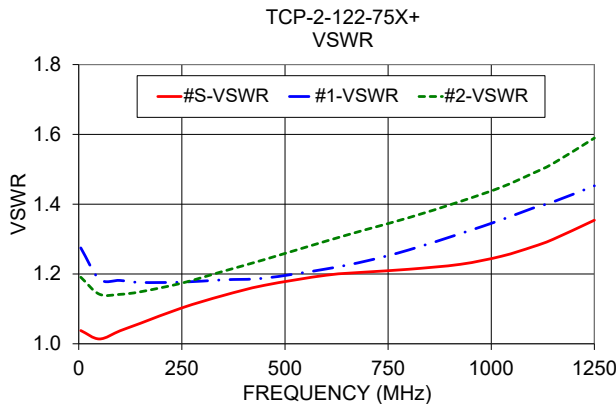
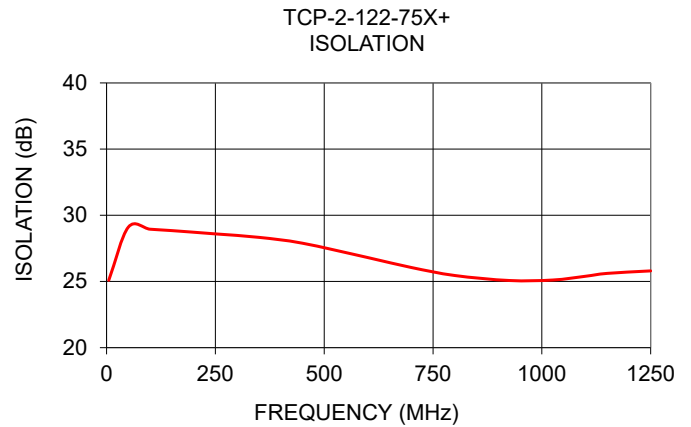
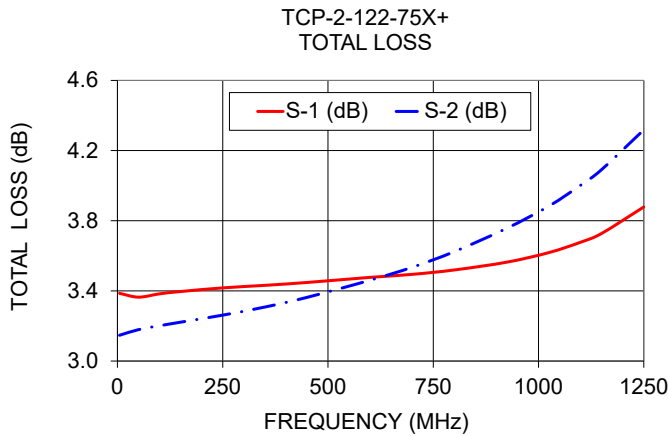

- NOTES**
- A. Performance and quality attributes and conditions not expressly stated in this specification document are intended to be excluded and do not form a part of this specification document.
 - B. Electrical specifications and performance data contained in this specification document are based on Mini-Circuit's applicable established test performance criteria and measurement instructions.
 - C. The parts covered by this specification document are subject to Mini-Circuits standard limited warranty and terms and conditions (collectively, "Standard Terms"); Purchasers of this part are entitled to the rights and benefits contained therein. For a full statement of the standard. Terms and the exclusive rights and remedies thereunder, please visit Mini-Circuits' website at www.minicircuits.com/terms/viewterm.html

Looking for pricing, stock, or lifecycle information?

Click below to explore more details on WIN SOURCE:

 [View TCP-2-122-75X+ on WIN SOURCE](#)

 [Mini-Circuits Information](#)

Optimize Your Supply Chain with WIN SOURCE Solutions

-  Global Sourcing Solution
-  Obsolete Management
-  Cost Control Management
-  Shortage Management
-  Alternative Solution
-  Excess Inventory Management