

Multi-stage general purpose AC/DC EMC/RFI Filter



- Rated currents from 1 to 30 A
- High differential and common-mode attenuation
- Optional medical versions (B type)
- Optional safety versions (A type)



Performance indicators

Attenuation performance



Rated current [A]

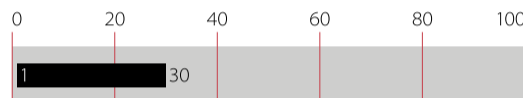

Approvals & Compliances



Features and Benefits

- FN 2060 two-stage filters are designed for easy and fast chassis mounting
- FN 2060 B versions without capacitors to earth comply to 1MOP for ME (medical equipment) acc. IEC 60601-1
- FN 2060 A version with low capacitance to earth for safety critical applications with necessity for low leakage currents
- All filters provide a high conducted attenuation performance, based on chokes with high saturation resistance and excellent thermal behavior
- FN 2060 two-stage filters are designed for noisy applications requiring good differential and common-mode attenuation
- FN 2060 filters are also available as single-stage filters (FN 2010 series)
- Various terminal options allow you to select the desired connection style

Technical Specifications

Maximum continuous operating voltage	250 VAC, 50/60 Hz 250 VDC
Nominal operating voltage	230 VAC
Rated currents	1 to 30 A @ 40°C
Operating frequency	DC to 400 Hz
High potential test voltage	P → PE 2000 VAC for 2 sec P → PE 2500 VAC for 2 sec (B types) P → N 1100 VDC for 2 sec
Overtoltage category	II acc. IEC 60664-1
Pollution degree	2 acc. IEC 60664-1
Temperature range (operation and storage)	-25°C to +100°C (25/100/21)**
Altitude	2000m (above derating applies)**
Flammability corresponding to	Laces for -07 version: UL 94 VW-1 Terminal plastic for -06/-08 version: UL 94 V-0 Grommet for -07 version: UL 94 V-0
Certified to	UL 1283, CSA 22.2 No. 8 1986, IEC/EN 60939 (applies to AC and DC applications)
Design corresponding to	UL 1283, CSA 22.2 No. 8 1986, IEC/EN 60939
MTBF (Mil-HB-217F)	>950,000 h @ 40°C/230 V 1,650,000 h (B types) @ 40°C/230 V

* maximum RMS operating voltage at rated frequency or the maximum DC operating voltage
 ** for dedicated requests exceeding this specification (e.g. -40 °C or higher altitude) please contact your local Schaffner Sales office







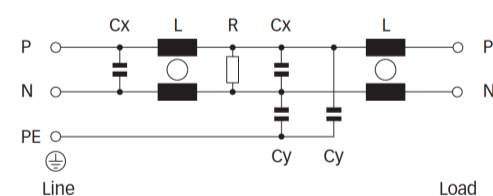



















Typical Applications

- Electrical and electronic equipment
- Consumer goods
- Household equipment
- Building automation
- Industrial applications
- Machinery
- Medical equipment
- Electronic data processing equipment
- Office automation and datacom equipment
- Various noisy applications requiring good filter performance

Typical electrical schematic



Filter Selection Table

Filter*	Buy	Rated current @ 40°C (25°C)	Leakage current** @ 250 VAC/50 Hz (@ 120 VAC/60 Hz)	Power Loss @25°C/DC	Inductance*** L	Capacitance***		Resistance*** R	Input/Output connections			Weight [g]
						Cx	Cy					
		[A]	[mA]	[W]	[mH]	[µF]	[nF]	[kΩ]				
FN2060-1-..		1 (1.2)	0.66 (0.38)	1.6	12	0.22	4.7	1000	-06	-07		120
FN2060-3-..		3 (3.5)	0.66 (0.38)	2.2	2.5	0.22	4.7	1000	-06	-07		120
FN2060-6-..		6 (6.9)	0.66 (0.38)	3.2	0.97	0.22	4.7	1000	-06	-07		120
FN2060-10-..		10 (11.5)	0.66 (0.38)	4.3	0.8	0.47	4.7	470	-06	-07	-08	190
FN2060-12-..		12 (13.8)	0.66 (0.38)	6.2	0.58	0.47	4.7	470	-06	-07	-08	190
FN2060-16-..		16 (18.4)	0.66 (0.38)	4.4	0.65	0.33	4.7	1000	-06	-07	-08	260
FN2060-20-..		20 (23)	0.66 (0.38)	5.3	0.6	1	4.7	220	-06		-08	480
FN2060-30-08		30 (34.5)	0.79 (0.45)	9.1	0.6	1	10	220			-08	950
FN2060A-1-..		1 (1.2)	0.07 (0.04)	1.6	12	0.22	0.47	1000	-06	-07		120
FN2060A-3-..		3 (3.5)	0.07 (0.04)	2.2	2.5	0.22	0.47	1000	-06	-07		120
FN2060A-6-..		6 (6.9)	0.07 (0.04)	3.2	0.97	0.22	0.47	1000	-06	-07		120
FN2060A-10-..		10 (11.5)	0.07 (0.04)	4.3	0.8	0.47	0.47	470	-06	-07	-08	190
FN2060A-12-..		12 (13.8)	0.07 (0.04)	6.2	0.58	0.47	0.47	470	-06	-07	-08	190
FN2060A-16-..		16 (18.4)	0.07 (0.04)	4.4	0.65	0.33	0.47	1000	-06	-07	-08	260
FN2060A-20-..		20 (23)	0.07 (0.04)	5.3	0.6	1	0.47	220	-06		-08	480
FN2060A-30-08		30 (34.5)	0.07 (0.04)	9.1	0.6	1	0.47	220			-08	950
FN2060B-1-..		1 (1.2)	0.00	1.6	12	0.22		1000	-06	-07		120
FN2060B-3-..		3 (3.5)	0.00	2.2	2.5	0.22		1000	-06	-07		120
FN2060B-6-..		6 (6.9)	0.00	3.2	0.97	0.22		1000	-06	-07		120
FN2060B-10-..		10 (11.5)	0.00	4.3	0.8	0.47		470	-06	-07	-08	190
FN2060B-12-..		12 (13.8)	0.00	6.2	0.58	0.47		470	-06	-07	-08	190
FN2060B-16-..		16 (18.4)	0.00	4.4	0.65	0.33		1000	-06	-07	-08	260
FN2060B-20-..		20 (23)	0.00	5.3	0.6	1		220	-06		-08	480
FN2060B-30-08		30 (34.5)	0.00	9.1	0.6	1		220			-08	950

* To compile a complete part number, please replace the -.. with the required I/O connection style (e.g. FN 2070-25-08, FN 2070B-10-06).

** Maximum leakage under usual AC operating conditions (acc. IEC60939-3). Note: if the neutral line is interrupted, worst case leakage could reach twice this level.

*** Tolerances apply: Inductance: -30/+50%, Capacitance: ±20%, Resistance: ±10%

Typical Filter Attenuation

Per CISPR 17: symmetrical 50 Ω/50 Ω -> Differential Mode (DM); asymmetrical 50 Ω/50 Ω -> Common Mode (CM)

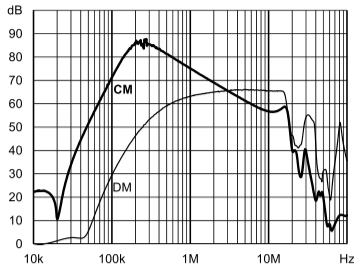

1 A: Standard type

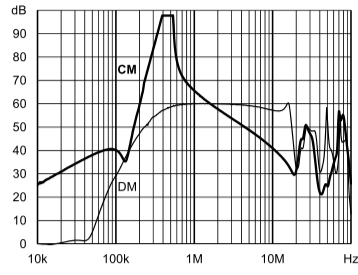

A type

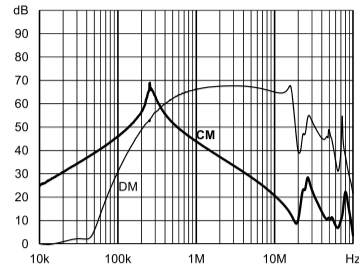

B type

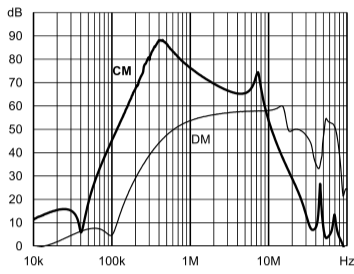

3 A: Standard type

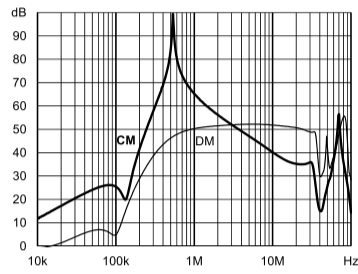

A type

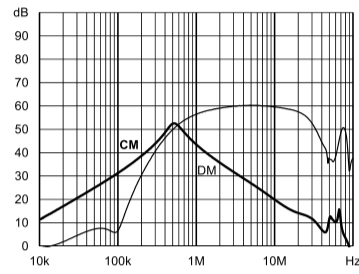

B type

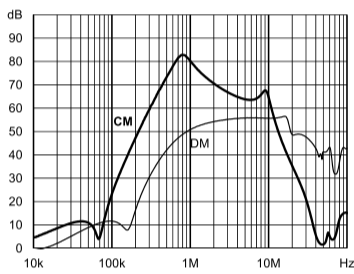

6 A: Standard type

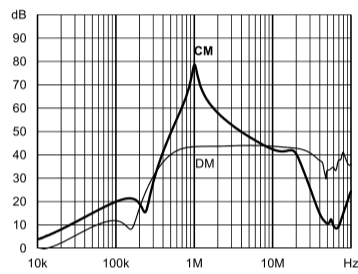

A type

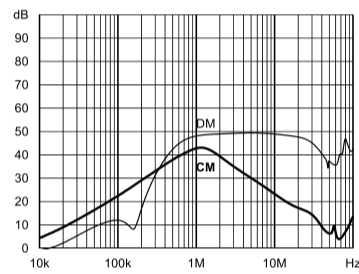

B type

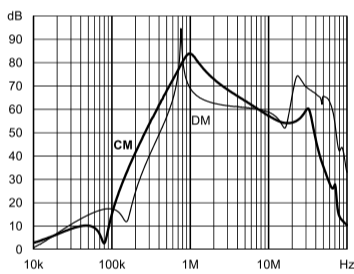

10 A: Standard type

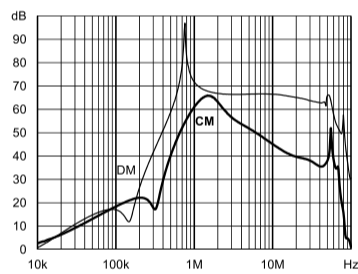

A type

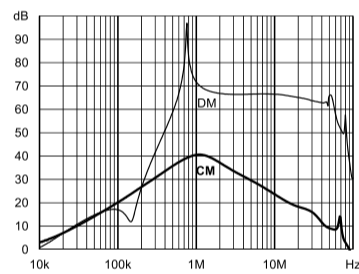

B type

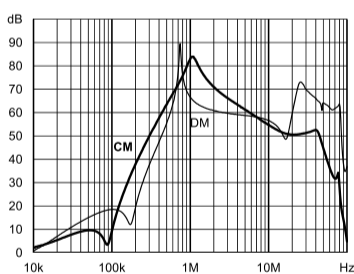

12 A: Standard type

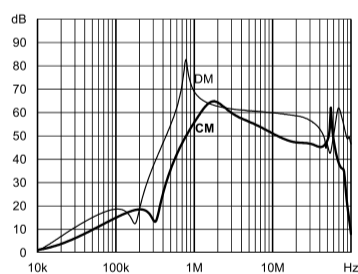

A type

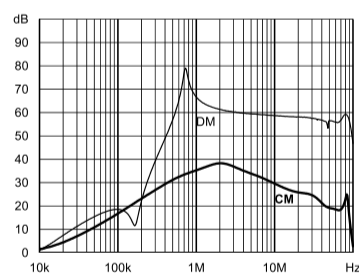

B type

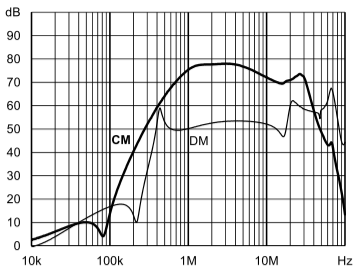

16 A: Standard type

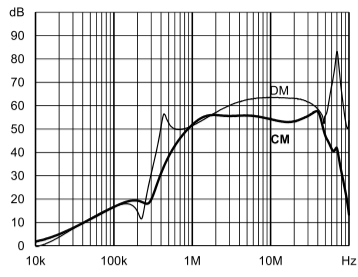

A type

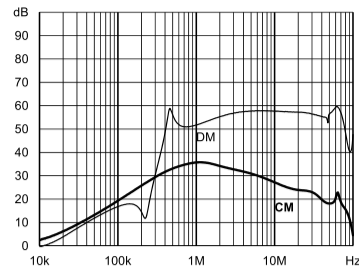

B type

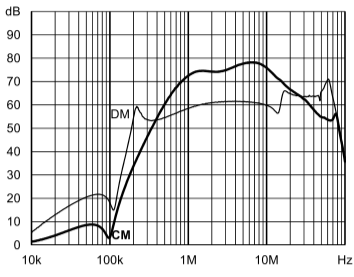

20 A: Standard type

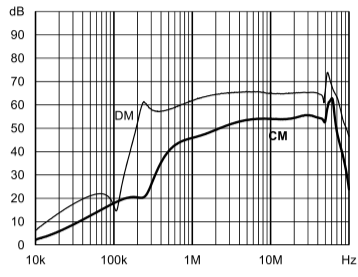

A type

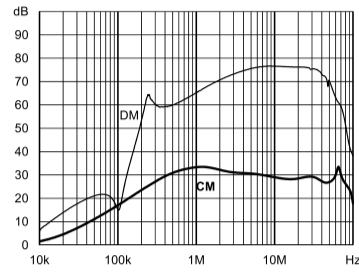

B type

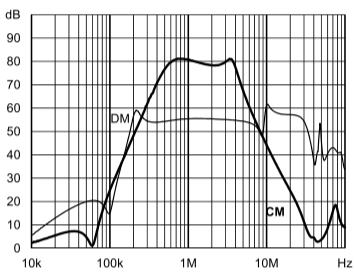

30 A: Standard type

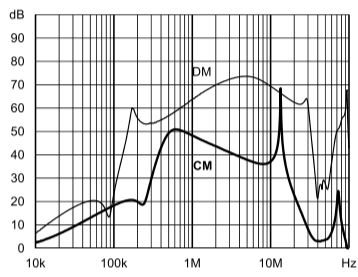

A type

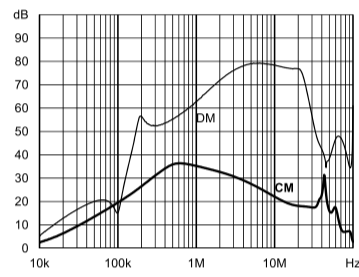

B type

Product selector		
FN 2060 x -xx-yy	06	Faston 6,3 × 0,8 mm (spade/soldering)
	07	Wire leads
	08	Studs (M4 screws)
	1 to 30	Rated current
	Blank	Standard version
	A	Safety version
	B	Medical version

Mechanical Data

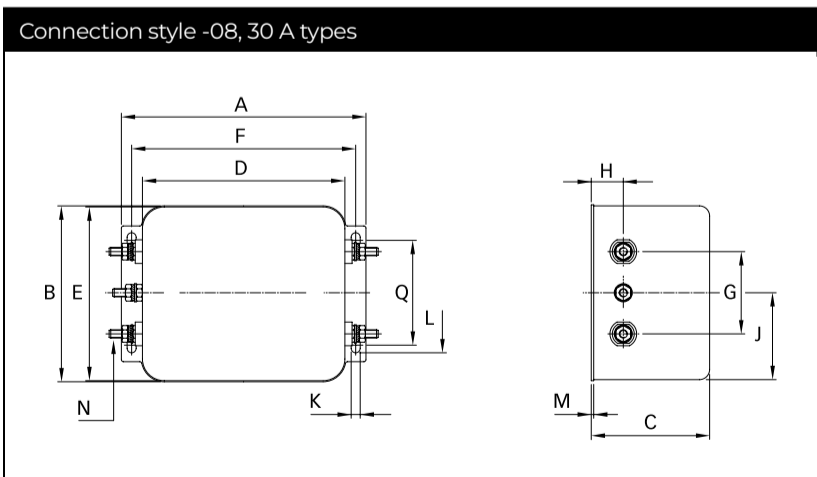
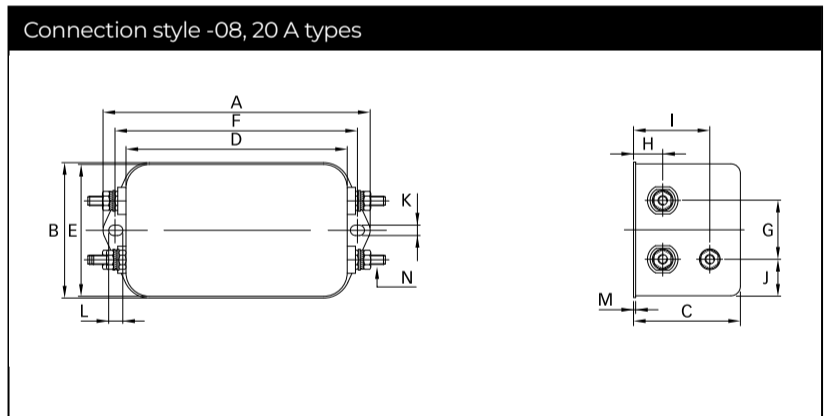
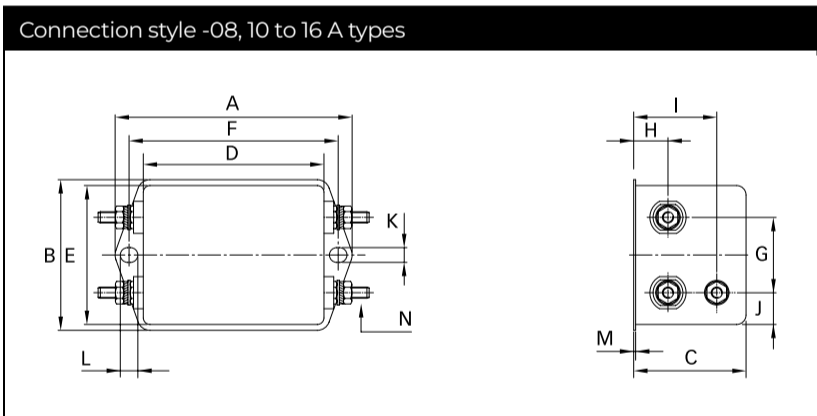
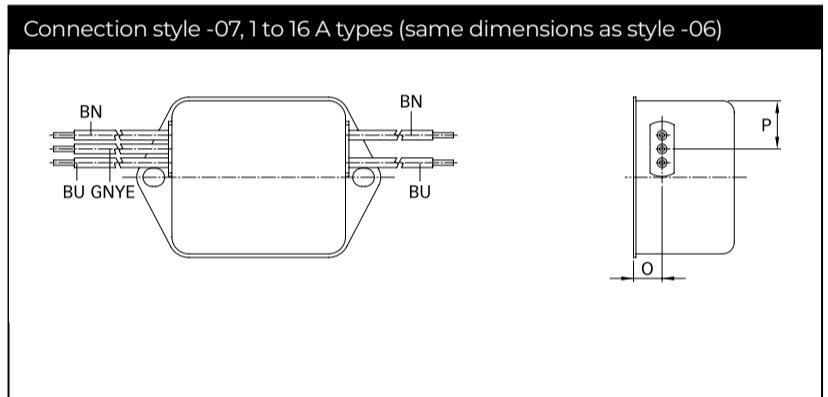
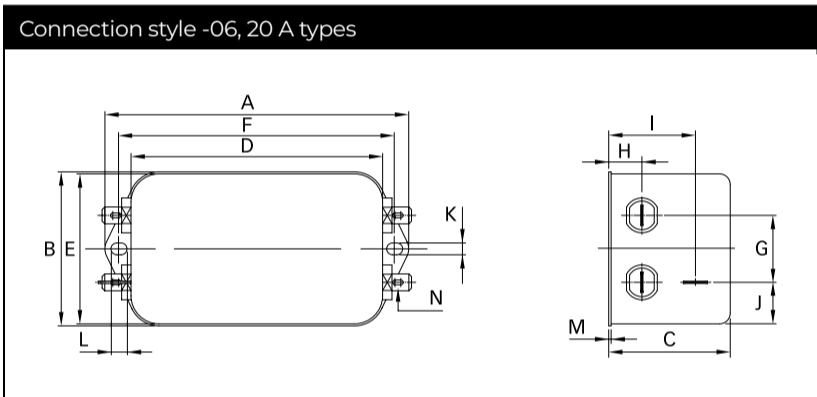
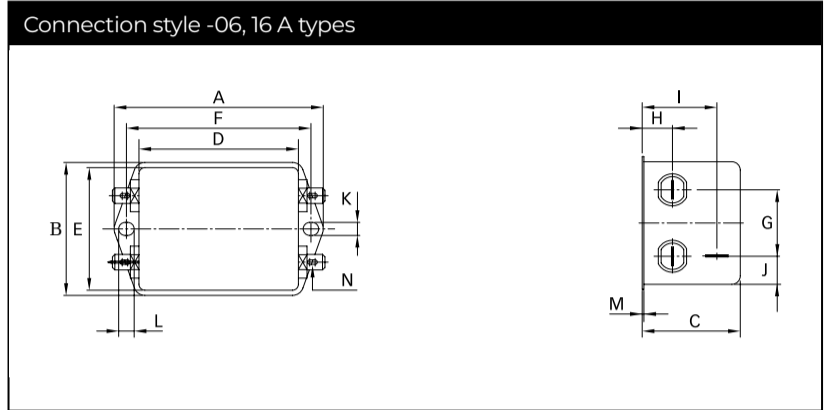
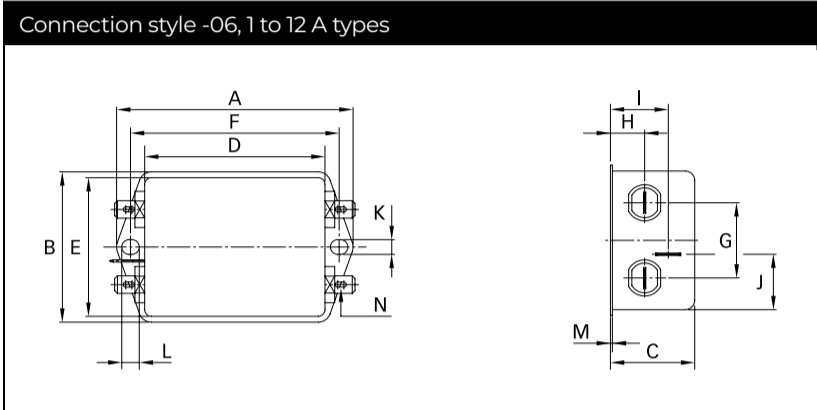

Dimensions

	1 A	3 A	6 A	10 A	12 A	16 A	20 A	30 A	Tolerances
A	71	71	71	85	85	85	113.5 ±1	119 ±1	±0.5
B	46.6	46.6	46.6	54	54	54	57.5 ±1	85.5 ±1	±0.5
C	29.3	29.3	29.3	30.3	30.3	40.3	45.4 ±1	57.6 ±1	±0.5
D	50.5	50.5	50.5	64.8	64.8	64.8	94 ±1	98.5 ±1	±0.5
E	44.5	44.5	44.5	49.8	49.8	49.8	56	84.5	±0.5
F	61	61	61	75	75	75	103	109	±0.3
G	21	21	21	27	27	27	25	40	±0.2
H	10.8	10.8	10.8	12.3	12.3	12.3	12.4	15.6	±0.5
I	19.3	19.3	19.3	20.8	20.8	29.8	32.4		±0.5
J	20.1	20.1	20.1	19.9	19.9	11.4	15.5	42.25	±0.5
K	5.3	5.3	5.3	5.3	5.3	5.3	4.4	4.4	
L	6.3	6.3	6.3	6.3	6.3	6.3	6	7.4	
M	0.7	0.7	0.7	0.7	0.7	0.7	1	1.2	±0.3
Connection style -06									
N	6.3 x 0.8	6.3 x 0.8	6.3 x 0.8	6.3 x 0.8	6.3 x 0.8	6.3 x 0.8	6.3 x 0.8	6.3 x 0.8	
Connection style -07									
O	8.3	8.3	8.3	8.3	8.3	8.3			±0.5
P	14	14	14	14.9	14.9	14.9			
AWG type wire	AWG 20	AWG 20	AWG 18	AWG 18	AWG 16	AWG 16			
Wire length	140	140	140	140	140	140			+5
Connection style -08									
N				M4	M4	M4	M4	M4	
Q								51	±0.2
Recommended torque (Nm)				1.2 - 1.3	1.2 - 1.3	1.2 - 1.3	1.2 - 1.3	1.2 - 1.3	
Earth terminal				1.5 - 1.7	1.5 - 1.7	1.5 - 1.7	1.5 - 1.7		

All dimensions in mm; 1 inch = 25.4 mm

Tolerances according: ISO 2768-m/EN 22768-m

Please visit www.schaffner.com to find more details on filter connections.

We are here to help



Read more insights from TE's experts:

Connect With Us

We make it easier to connect with our experts and are ready to provide the support you need. Visit te.com/support to chat with a Product Information Specialist.

te.com

©2025 TE Connectivity plc. All Rights Reserved.

TE Connectivity, TE, TE connectivity (logo), and EVERY CONNECTION COUNTS, ECOSine, Schaffner are trademarks owned or licensed by TE Connectivity plc. family of companies. All other logos, products and/or company names referred to herein might be trademarks of their respective owners.

While TE has made every reasonable effort to ensure the accuracy of the information in this document, TE does not guarantee that it is error-free, nor does TE make any other representation, warranty or guarantee that the information is accurate, correct, reliable or current. TE reserves the right to make any changes to the information contained herein without prior notice. TE Connectivity assumes only those obligations set forth in the terms and conditions for this product and shall in no event be liable for any incidental, indirect, or consequential damages arising out of the sale, resale, use, or misapplication of the product. TE expressly disclaims any implied warranties with respect to the information contained herein, including, but not limited to, implied warranties of merchantability or fitness for a particular purpose. Dimensions, specifications and/or information contained herein are for reference purposes only and are subject to change without notice. Consult TE for the latest dimensions, specifications and/or information. Users of TE Connectivity products must make their own assessment as to whether the respective product is suitable for the respective desired application.

ED 01/25

schaffner
MORE POWER TO YOU

is now part of

TE
connectivity

Looking for pricing, stock, or lifecycle information?

Click below to explore more details on WIN SOURCE:

- [View FN2060-12-06 on WIN SOURCE](#)
- [Schaffner EMC Inc. Information](#)

Optimize Your Supply Chain with WIN SOURCE Solutions

- ✓ Global Sourcing Solution
- ✓ Obsolete Management
- ✓ Cost Control Management
- ✓ Shortage Management
- ✓ Alternative Solution
- ✓ Excess Inventory Management