

Multi-stage AC/DC EMC/RFI Filter with Excellent Attenuation Performance



- Rated currents from 1 to 30 A
- Two-stage filter
- Very high differential and common-mode attenuation
- Optional medical versions (B type)
- Optional safety versions (A type)
- Optional enhanced performance versions
- Optional overvoltage protection (Z type)



Performance indicators

Attenuation performance



Rated current [A]

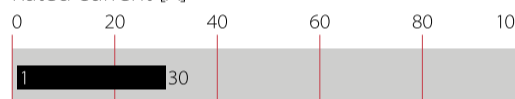

Approvals & Compliances



Features and Benefits

- FN 2090 two-stage filters are designed for easy and fast chassis mounting.
- FN 2090 B versions without capacitors to earth comply to 1MOP for ME (medical equipment) acc. IEC 60601-1
- FN 2090 A versions with low capacitance to earth for safety critical applications with a requirement for low leakage currents.
- FN 2090 filters offers an optimized filter range for enhanced performance AC and DC applications, in same compact size (KK, LL, NN types)
- All filters provide an exceptional conducted attenuation performance, based on chokes with high permeable core material.
- FN 2090 two-stage filters are designed for noisy applications requiring excellent filter performance.
- The higher inductivity offers increased attenuation performance with the same form factor as FN 2060 and FN 2080 series.
- All FN 2090 filters can be delivered with optional surge pulse protection (Z type).
- FN 2090 filters are also available as singlestage filters (FN 2030 series).
- Various terminal options allow you to select the desired connection style.

Technical Specifications

Maximum continuous operating voltage	250 VAC, 50/60 Hz 250 VDC
Nominal operating voltage	230 VAC
Rated currents	1 to 30 A @ 40°C
Operating frequency	DC to 400 Hz
High potential test voltage	P → N 1100 VDC for 2 sec P → PE 2000 VAC for 2 sec (equiv. cap <88 nF) P → PE 2550 VDC for 2 sec (equiv. cap >88 nF) P → PE 2500 VAC for 2 sec (B types)
Overvoltage category	II acc. IEC 60664-1
Pollution degree	2 acc. IEC 60664-1
Surge pulse protection (Z type)	Helps compliance to IEC61000-4-5 (Differential Mode only)
Temperature range (operation and storage)	-25°C to +100°C (25/100/21)**
Altitude	2000m (above derating applies)**
Flammability corresponding to	Laces for -07 version: UL 94 VW-1 Terminal plastic for -06/-08 version: UL 94 V-0 Grommet for -07 version: UL 94 V-0
Certified to	UL 1283, CSA 22.2 No. 8 1986, IEC/EN 60939 (applies to AC and DC applications)
MTBF (Mil-HB-217F)	≤10 A: >1,300,000 h @ 40°C/230 V ≥12 A: >1,100,000 h @ 40°C/230 V

* maximum RMS operating voltage at rated frequency or the maximum DC operating voltage
 ** for dedicated requests exceeding this specification (e.g. -40 °C or higher altitude) please contact your local Schaffner Sales office

Typical Applications

- Electrical and electronic equipment
- Consumer goods
- Household equipment
- Building automation
- Industrial applications
- Machinery
- Medical equipment
- Electronic data processing equipment
- Office automation and datacom equipment
- Various noisy applications requiring high filter performance

Typical electrical schematic

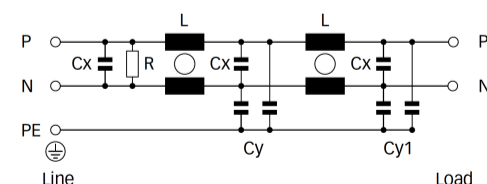

Filter Selection Table

Filter*	Buy	Rated current @ 40°C (25°C) [A]	Leakage current** @ 250V AC/50 Hz (@ 120V AC/60 Hz) [mA]	Power Loss @ 25°C/DC [W]	Inductance*** L [mH]	Capacitance***			Resistance*** R [kΩ]	Input/Output connections			Weight [g]
						Cx [μF]	Cy1 [nF]	Cy2 [nF]					
FN2090-1-..		1 (1.1)	0.45 (0.26)	1.8	20	0.22	2.2	1.0	680	-06	-07		73
FN2090-3-..		3 (3.4)	0.45 (0.26)	3.7	14	0.33	2.2	1.0	470	-06	-07		158
FN2090-4-..		4 (4.5)	0.45 (0.26)	6.4	14	0.33	2.2	1.0	470	-06	-07		176
FN2090-6-..		6 (6.7)	0.61 (0.35)	7.1	8	0.47	3.3	1.0	330	-06	-07	-08	191
FN2090-8-..		8 (8.9)	0.61 (0.35)	7.7	8	0.47	3.3	1.0	330	-06	-07		330
FN2090-10-..		10 (11.2)	0.61 (0.35)	8.4	8	0.47	3.3	1.0	330	-06	-07	-08	369
FN2090-12-..		12 (13.4)	0.93 (0.54)	12.1	4	1	10	1.0	220	-06	-07	-08	391
FN2090-16-..		16 (17.9)	0.93 (0.54)	10.7	4	1	10	1.0	220	-06	-07		425
FN2090-20-..		20 (22.4)	0.93 (0.54)	8.2	2.7	1	10	1.0	220	-06		-08	530
FN2090-30-08		30 (33.5)	0.93 (0.54)	10.1	1.5	1	10	1.0	220			-08	548
Enhanced performance													
FN2090A-1-..		1 (1.1)	0.13 (0.07)	1.8	20	0.22	0.47	0.47	680	-06	-07		73
FN2090A-3-..		3 (3.4)	0.13 (0.07)	3.7	14	0.33	0.47	0.47	470	-06	-07		158
FN2090A-4-..		4 (4.5)	0.13 (0.07)	6.4	14	0.33	0.47	0.47	470	-06	-07		176
FN2090A-6-..		6 (6.7)	0.13 (0.07)	7.1	8	0.47	0.47	0.47	330	-06	-07	-08	191
FN2090A-8-..		8 (8.9)	0.13 (0.07)	7.7	8	0.47	0.47	0.47	330	-06	-07		330
FN2090A-10-..		10 (11.2)	0.13 (0.07)	8.4	8	0.47	0.47	0.47	330	-06	-07	-08	369
FN2090A-12-..		12 (13.4)	0.13 (0.07)	12.1	4	1	0.47	0.47	220	-06	-07	-08	391
FN2090A-16-..		16 (17.9)	0.13 (0.07)	10.7	4	1	0.47	0.47	220	-06	-07		425
FN2090A-20-..		20 (22.4)	0.13 (0.07)	8.2	2.7	1	0.47	0.47	220	-06		-08	530
FN2090A-30-08		30 (33.5)	0.13 (0.07)	10.1	1.5	1	10	10	220			-08	548
FN2090B-1-..		1 (1.1)	0.00	1.8	20	0.22			680	-06	-07		73
FN2090B-3-..		3 (3.4)	0.00	3.7	14	0.33			470	-06	-07		158
FN2090B-4-..		4 (4.5)	0.00	6.4	14	0.33			470	-06	-07		176
FN2090B-6-..		6 (6.7)	0.00	7.1	8	0.47			330	-06	-07	-08	191
FN2090B-8-..		8 (8.9)	0.00	7.7	8	0.47			330	-06	-07		330
FN2090B-10-..		10 (11.2)	0.00	8.4	8	0.47			330	-06	-07	-08	369
FN2090B-12-..		12 (13.4)	0.00	12.1	4	1			220	-06	-07	-08	391
FN2090B-16-..		16 (17.9)	0.00	10.7	4	1			220	-06	-07		425
FN2090B-20-..		20 (22.4)	0.00	8.2	2.7	1			220	-06		-08	530
FN2090B-30-08		30 (33.5)	0.00	10.1	1.5	1			220			-08	548
FN2090KK-1-06		1 (1.15)	3.46 (1.99)	1.8	20	0.22	22	22	680	-06	-07		95
FN2090NN-3-06		3 (3.4)	15.71 (9.05)	3.7	14	0.33	100	100	470	-06			200
FN2090NN-4-06		4 (4.5)	15.71 (9.05)	6.4	14	0.33	100	100	470	-06			210
FN2090NN-6-06		6 (6.7)	15.71 (9.05)	7.1	8	0.47	100	100	330	-06			220
FN2090NN-8-06		8 (8.9)	15.71 (9.05)	7.7	8	0.47	100	100	330	-06			340
FN2090LL-10-..		10 (11.2)	5.18 (2.98)	8.4	8	0.47	33	33	330	-06		-08	470
FN2090LL-12-..		12 (13.4)	5.18 (2.98)	12.1	4	1	33	33	220	-06		-08	500
FN2090LL-16-06		16 (17.9)	5.18 (2.98)	10.7	4	1	33	33	220	-06			530
FN2090LL-20-..		20 (23)	5.18 (2.98)	8.2	2.7	1	33	33	220	-06		-08	580
FN2090LL-30-08		30 (33.5)	5.18 (2.98)	10.1	1.5	1	33	33	220			-08	600

* To compile a complete part number, please replace the .. with the required I/O connection style. For surge pulse protection, please add Z (e.g.

FN2090Z-10-06, FN2090BZ-20-08). The different letters code the used Cy values in the filter type (A = 0.47nF; K = 22nF; L = 33nF; N = 100nF; as the FN2090 is a dual stage filter each letter stands for one stage of Cy)

** Maximum leakage under usual AC operating conditions (acc. IEC 60939-3). Note: if the neutral line is interrupted, worst case leakage could reach twice this level. Leakage current for DC application is 0mA

*** Tolerances apply: Inductance: -30/+50%, Capacitance: ±20%, Resistance: ±10%

Typical Filter Attenuation

Per CISPR 17: symmetrical 50 Ω/50 Ω -> Differential Mode (DM); asymmetrical 50 Ω/50 Ω -> Common Mode (CM)

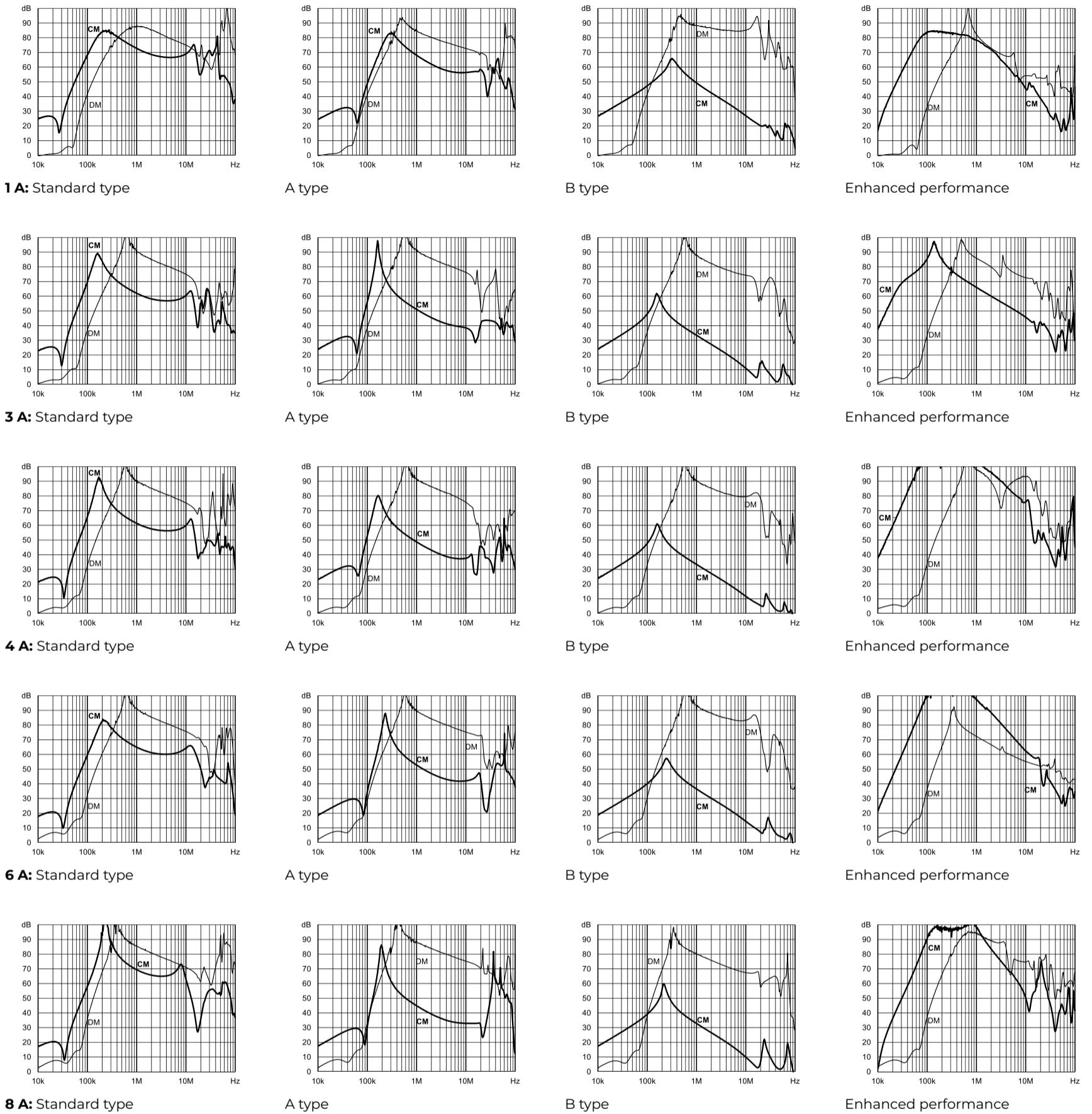

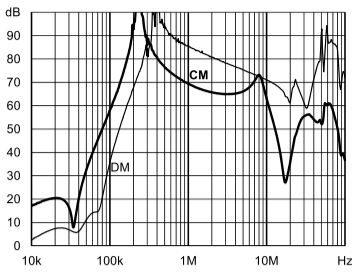

10 A: Standard type

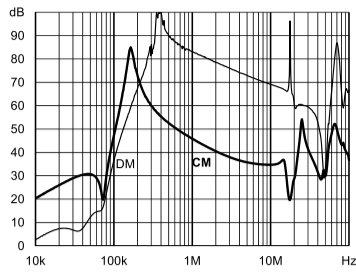

A type

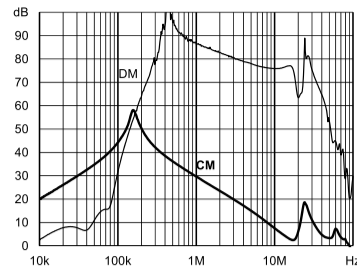

B type

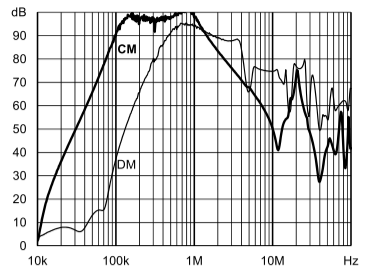

Enhanced performance

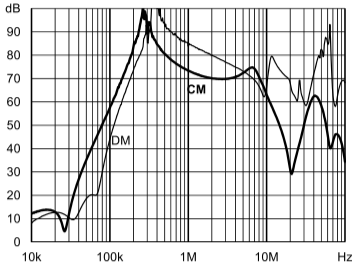

12 A: Standard type

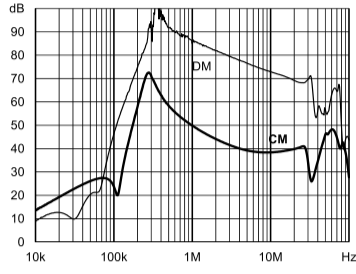

A type

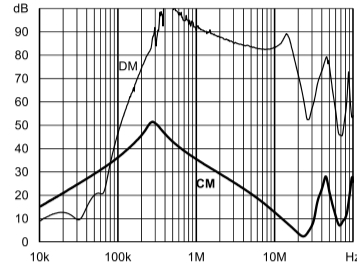

B type

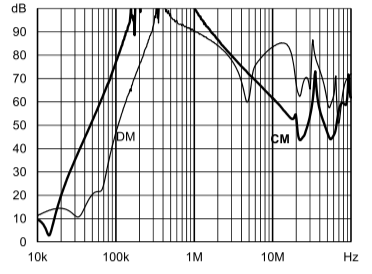

Enhanced performance

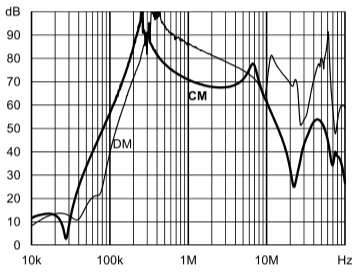

16 A: Standard type

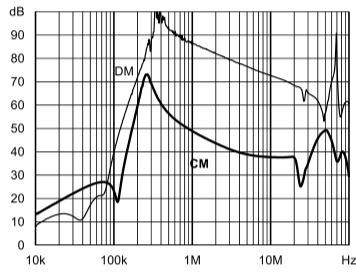

A type

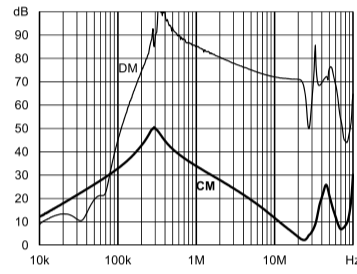

B type

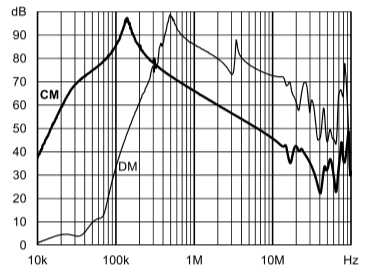

Enhanced performance

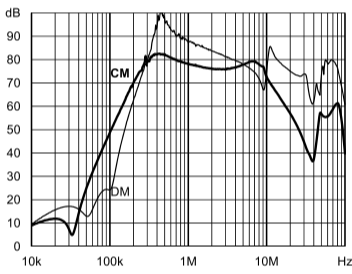

20 A: Standard type

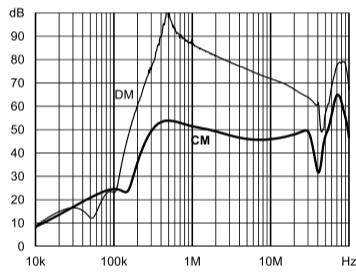

A type

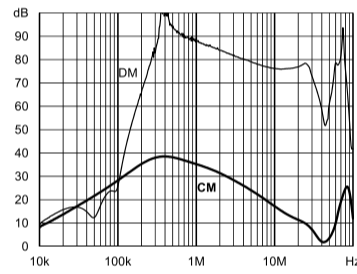

B type

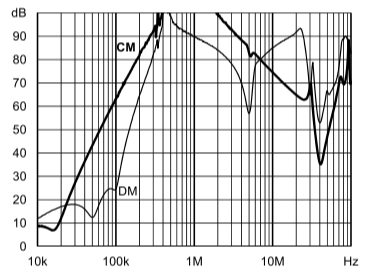

Enhanced performance

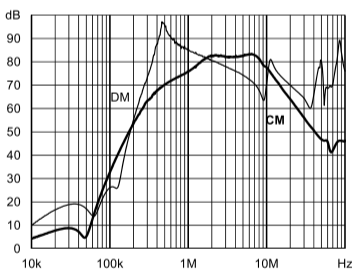

30 A: Standard type

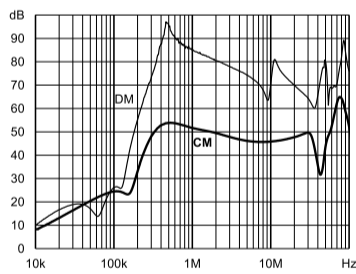

A type

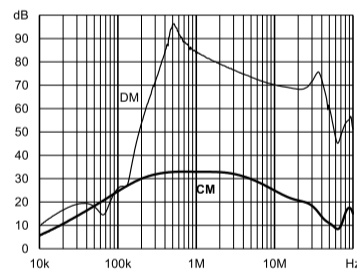

B type

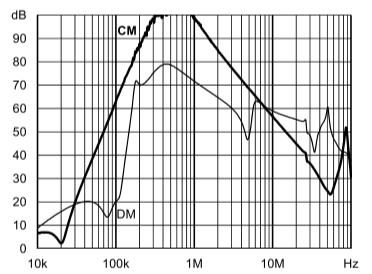

Enhanced performance

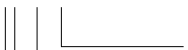
Product Selector		
FN 2090 xy-xx-yy		
	06 07 08	Faston 6.3 × 0.8 mm (spade/soldering) Wire leads Studs (M4 screws)
	1 to 30	Rated current
	Blank Z	Standard version With surge protection
	Blank A B KK/LL/NN	Standard version Safety version Medical version High performance version

Mechanical Data

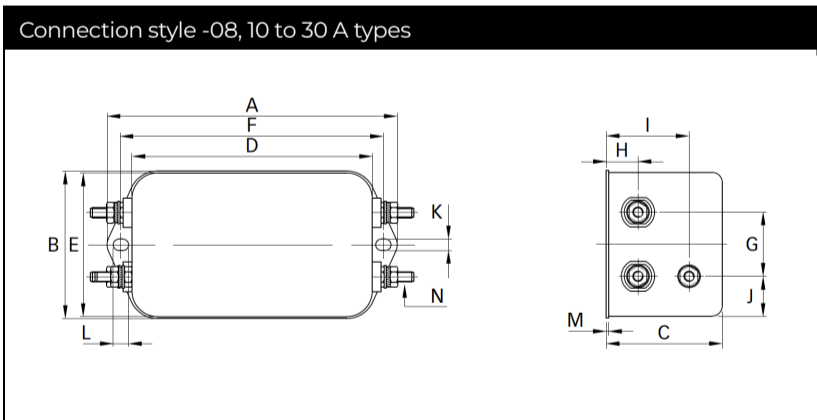
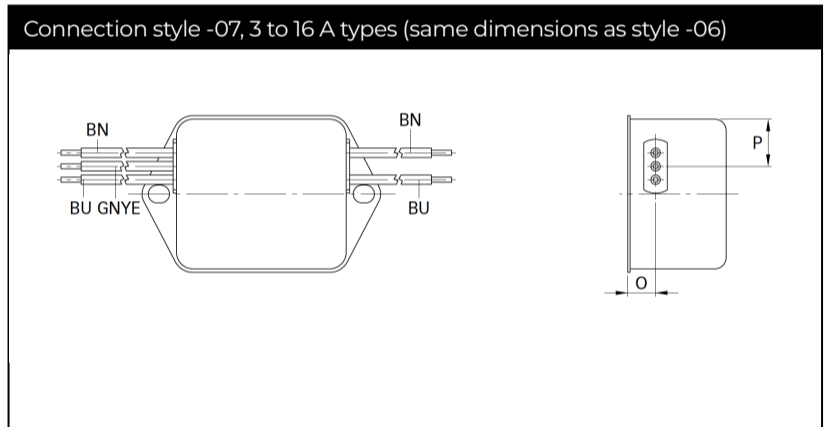
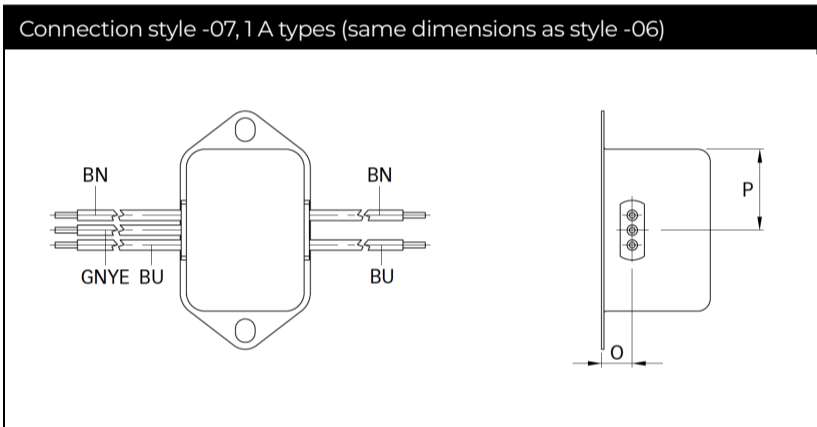
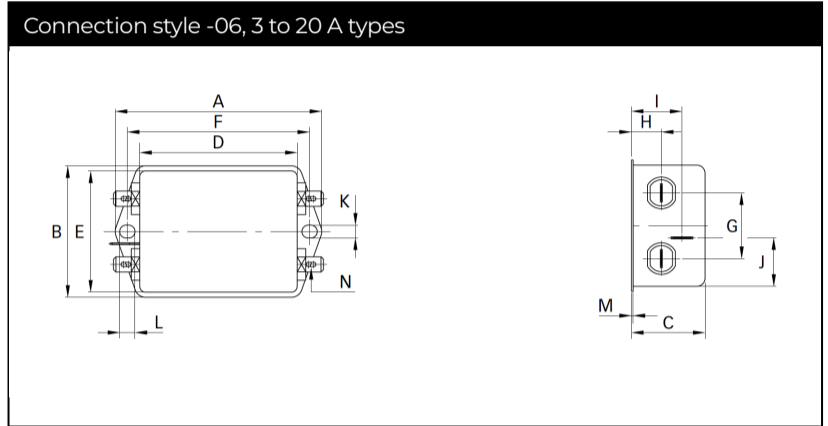
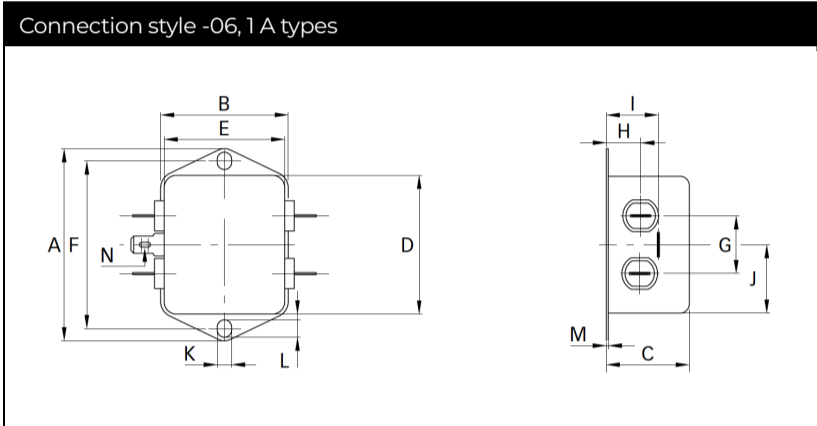

Dimensions

	1 A	3 A	4 A	6 A	8 A	10 A	12 A	16 A	20 A	30 A	Tolerances
A	71	85	85	85	113.5 ±1	113.5 ±1	113.5 ±1	113.5 ±1	113.5 ±1	113.5 ±1	±0.5
B	46.6	54	54	54	57.5 ±1	57.5 ±1	57.5 ±1	57.5 ±1	57.5 ±1	57.5 ±1	±0.5
C	22.3	30.3	30.3	30.3	45.4 ±1	45.4 ±1	45.4 ±1	45.4 ±1	45.4 ±1	45.4 ±1	±0.5
D	50.5	64.8	64.8	64.8	94 ±1	94 ±1	94 ±1	94 ±1	94 ±1	94 ±1	±0.5
E	44.5	49.8	49.8	49.8	56	56	56	56	56	56	±0.5
F	61	75	75	75	103	103	103	103	103	103	±0.3
G	21	27	27	27	25	25	25	25	25	25	±0.2
H	10.8	12.3	12.3	12.3	12.4	12.4	12.4	12.4	12.4	12.4	±0.5
I	16.8	20.8	20.8	20.8	32.4	32.4	32.4	32.4	32.4	32.4	±0.5
J	25.25	19.9	19.9	19.9	15.5	15.5	15.5	15.5	15.5	15.5	±0.5
K	5.3	5.3	5.3	5.3	4.4	4.4	4.4	4.4	4.4	4.4	
L	6.3	6.3	6.3	6.3	6	6	6	6	6	6	
M	0.7	0.7	0.7	0.7	1	1	1	1	1	1	±0.3
Connection style -06											
N	6.3 x 0.8	6.3 x 0.8	6.3 x 0.8	6.3 x 0.8	6.3 x 0.8	6.3 x 0.8	6.3 x 0.8	6.3 x 0.8	6.3 x 0.8	6.3 x 0.8	
Connection style -07											
O	8.3	8.3	8.3	8.3	8.4	8.4	8.4	8.4			±0.5
P	14	14.9	14.9	14.9	18	18	18	18			±0.5
AWG type wire	AWG 20	AWG 20	AWG 20	AWG 18	AWG 18	AWG 18	AWG 16	AWG 16			
Wire length	140	140	140	140	140	140	140	140			+5
Connection style -08											
N						M4	M4	M4	M4	M4	
Recommended torque (Nm)						1.2 - 1.3	1.2 - 1.3	1.2 - 1.3	1.2 - 1.3	1.2 - 1.3	
Earth terminal						1.5 - 1.7	1.5 - 1.7	1.5 - 1.7	1.5 - 1.7	1.5 - 1.7	

All dimensions in mm; 1 inch = 25.4 mm

Tolerances according: ISO 2768-m/EN 22768-m

Please visit www.schaffner.com to find more details on filter connectors.

We are here to help



Read more insights from TE's experts:

Connect With Us

We make it easier to connect with our experts and are ready to provide the support you need. Visit te.com/support to chat with a Product Information Specialist.

te.com

©2025 TE Connectivity plc. All Rights Reserved.

TE Connectivity, TE, TE connectivity (logo), and EVERY CONNECTION COUNTS, ECOSine, Schaffner are trademarks owned or licensed by TE Connectivity plc. family of companies. All other logos, products and/or company names referred to herein might be trademarks of their respective owners.

While TE has made every reasonable effort to ensure the accuracy of the information in this document, TE does not guarantee that it is error-free, nor does TE make any other representation, warranty or guarantee that the information is accurate, correct, reliable or current. TE reserves the right to make any changes to the information contained herein without prior notice. TE Connectivity assumes only those obligations set forth in the terms and conditions for this product and shall in no event be liable for any incidental, indirect, or consequential damages arising out of the sale, resale, use, or misapplication of the product. TE expressly disclaims any implied warranties with respect to the information contained herein, including, but not limited to, implied warranties of merchantability or fitness for a particular purpose. Dimensions, specifications and/or information contained herein are for reference purposes only and are subject to change without notice. Consult TE for the latest dimensions, specifications and/or information. Users of TE Connectivity products must make their own assessment as to whether the respective product is suitable for the respective desired application.

ED 01/25

schaffner
MORE POWER TO YOU

is now part of

TE
connectivity

Looking for pricing, stock, or lifecycle information?

Click below to explore more details on WIN SOURCE:

- [View FN2090B-6-06 on WIN SOURCE](#)
- [Schaffner EMC Inc. Information](#)

Optimize Your Supply Chain with WIN SOURCE Solutions

- ✓ Global Sourcing Solution
- ✓ Obsolete Management
- ✓ Cost Control Management
- ✓ Shortage Management
- ✓ Alternative Solution
- ✓ Excess Inventory Management