



MMIC SURFACE MOUNT

Power Splitter/Combiner

GP2S1A+

50Ω 500 to 2500 MHz DC PASSING

THE BIG DEAL

- Wide Bandwidth, 500 to 2500 MHz
- Excellent Insertion Loss, Typ. 1.0 dB
- Excellent Amplitude Unbalance, Typ. 0.02 dB
- Good Phase Unbalance, Typ. 0.4 Deg
- Power Handling as a Splitter, Max 10 W
- 3x3 mm 12-Lead QFN-Style Package
- DC Passing up to 370 mA

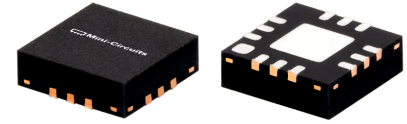

Generic photo used for illustration purposes only

APPLICATIONS

- Back Haul Radio Systems
- Radar, EW, and ECM Defense Systems
- Satellite Communications

FUNCTIONAL DIAGRAM

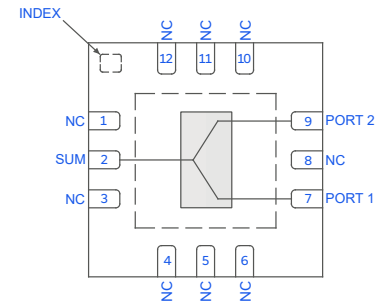

PRODUCT OVERVIEW

Mini-Circuits' GP2S1A+ is a 50Ω GaAs MMIC 2-way splitter/combiner that operates from 500 to 2500 MHz. The GP2S1A+ provides typical performance of 1.0 dB insertion loss, 22 dB isolation, 0.02 dB amplitude unbalance, and 0.4 deg phase unbalance. In conjunction, it has excellent power handling capabilities of 10 W max, with the ability to pass DC current up to 370 mA. This combination of characteristics makes it the perfect device for maintaining signal integrity and low signal distortion during signal splits, while also handling high power RF signals in tandem with DC current on a singular signal path.

KEY FEATURES

Features	Advantages
Low Insertion Loss, Typ. 1.0 dB (Above 3.0 dB Splitter Loss)	Low insertion loss ensures minimized signal power loss through the device, limiting the need for compensating power requirements at the respective outputs.
Excellent Unbalance <ul style="list-style-type: none"> • Amplitude Unbalance, Typ. 0.02 dB • Phase Unbalance, Typ. 0.4 deg. 	Strong unbalance characteristics allow for low signal distortion and maintaining signal integrity when splitting RF signals between respective outputs.
DC Passing	DC current passing capabilities are helpful in applications where both RF & DC need to pass on a singular path through the DUT.
3x3 mm 12-Lead QFN-Style Package	Small footprint saves space in dense layouts while providing low inductance, repeatable transitions, and excellent thermal contact to the PCB. Industry standard packaging allows for ease of assembly in high volume manufacturing processes.





MMIC SURFACE MOUNT

Power Splitter/Combiner

GP2S1A+

50Ω 500 to 2500 MHz DC PASSING

ELECTRICAL SPECIFICATIONS¹ AT +25°C & P_{IN} = -10 dBm, UNLESS NOTED OTHERWISE

Parameter	Condition (MHz)	Min.	Typ.	Max.	Units
Frequency Range		500		2500	MHz
Insertion Loss (Above 3.0 dB Splitter Loss)	500		0.9	1.3	dB
	1500		1.0	1.4	
	2500		1.5	1.8	
Isolation	500	8	12		dB
	1500	17	22		
	2500	15	19		
Amplitude Unbalance	500		0.01	0.2	dB
	1500		0.02	0.2	
	2500		0.02	0.2	
Phase Unbalance	500		0.1	2.0	Degrees
	1500		0.4	3.0	
	2500		0.6	4.0	
Return Loss (Sum Port)	500		15		dB
	1500		22		
	2500		17		
Return Loss (Ports 1, 2) ²	500		20		dB
	1500		26		
	2500		19		

1. Tested on Mini-Circuits Characterization Test Board TB-GP2S1AC+. See Figure 2. Board loss de-embedded to the device.

2. Typical values displayed are the worst case among Port 1 and Port 2.



TYPICAL PERFORMANCE GRAPHS

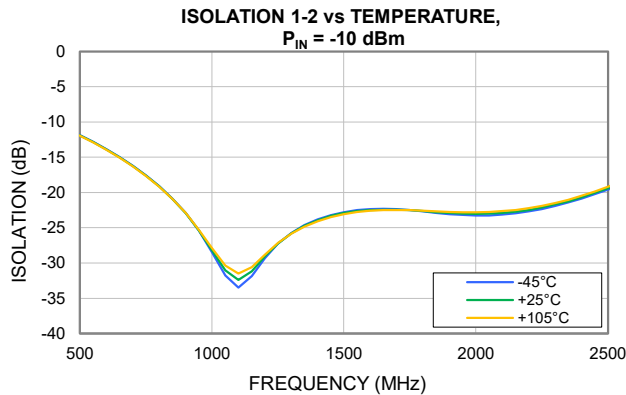
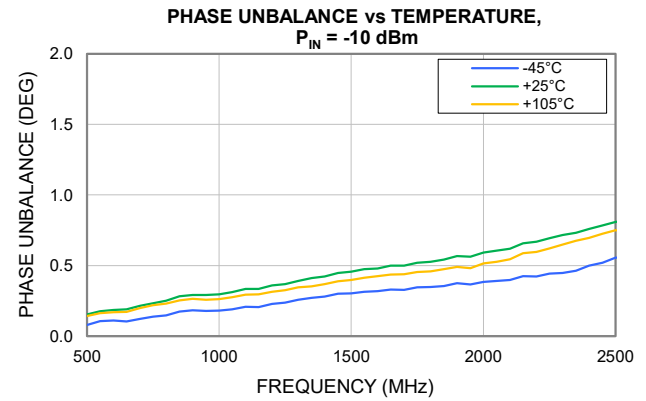
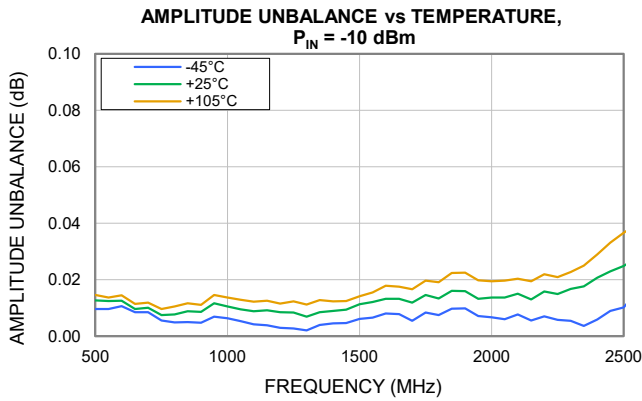
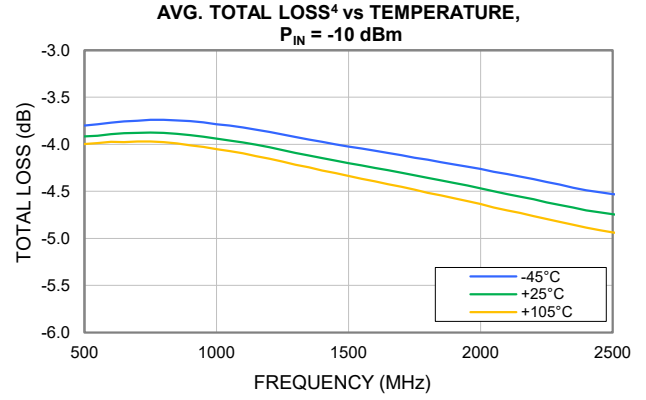
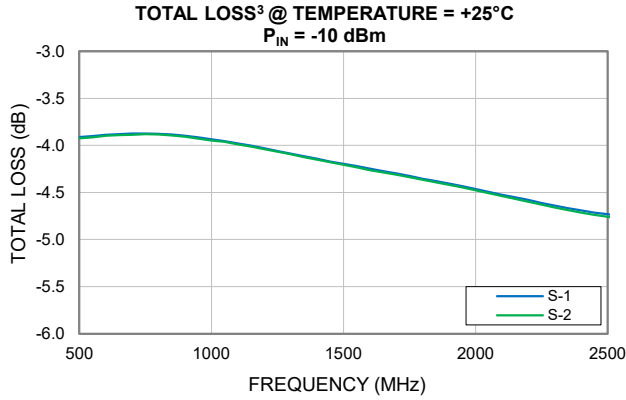

3. Total Loss = Single Path (S-1 or S-2) Insertion Loss + 3 dB Splitter Loss
 4. Average of both paths' Total Loss



TYPICAL PERFORMANCE GRAPHS

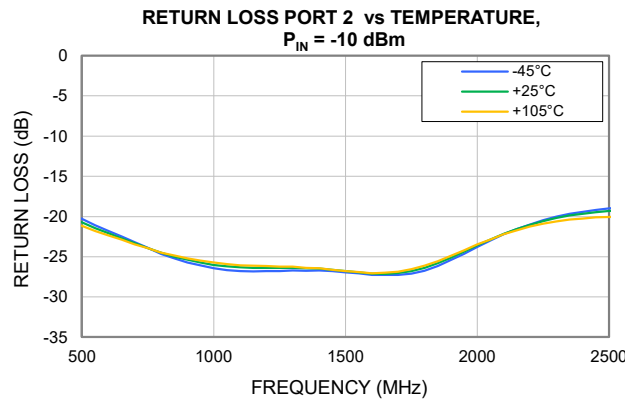
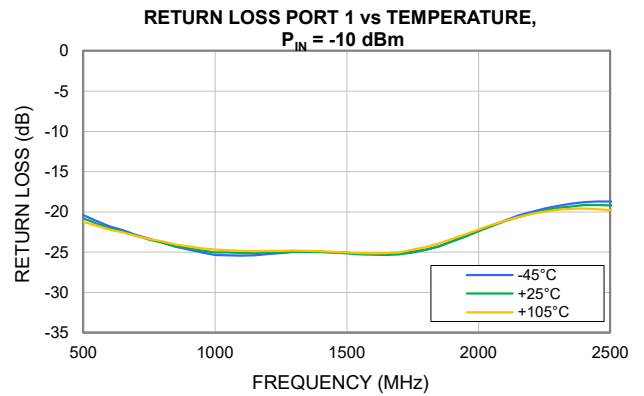
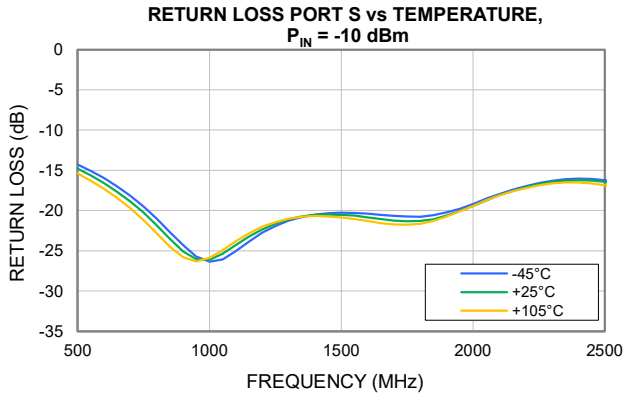



MMIC SURFACE MOUNT

Power Splitter/Combiner

GP2S1A+

50Ω 500 to 2500 MHz DC PASSING

ABSOLUTE MAXIMUM RATINGS⁵

Parameter	Ratings
Operating Temperature	-45°C to +105°C
Storage Temperature	-65°C to +150°C
Junction Temperature ⁶	+150°C
Power Input (CW) <ul style="list-style-type: none"> As a Splitter^{7,8} As a Combiner^{9,10} 	+40 dBm +35 dBm
DC Current	370 mA

5. Permanent damage may occur if any of these limits are exceeded. Maximum ratings are not intended for continuous normal operation.

6. Peak temperature on top of Die.

7. Tested by applying input power to Port S, measuring output power at Port 1, and presenting both an Open and 50Ω load at Port 2 to determine worst case conditions.

8. Max power rating at +25°C and +105°C; no derating required over temperature.

9. Tested by applying input power to Port 2, measuring output power at Port 1, and presenting both an Open and 50Ω load at Port S to determine worst case conditions.

10. Derates linearly to +32 dBm at +105°C.

ESD RATING

	Class	Voltage Range	Reference Standard
HBM	1B	500 V to < 1000 V	ANSI/ESDA/JEDEC JS-001-2023
CDM	C3	≥ 1000 V	ANSI/ESDA/JEDEC JS-002-2022



ESD HANDLING PRECAUTION: This device is designed to be Class 1B for HBM. Static charges may easily produce potentials higher than this with improper handling and can discharge into DUT and damage it. As a preventive measure Industry standard ESD handling precautions should be used at all times to protect the device from ESD damage.

MSL RATING

Moisture Sensitivity: MSL1 in accordance with IPC/JEDEC J-STD-020E/JEDEC J-STD-033C





FUNCTIONAL DIAGRAM

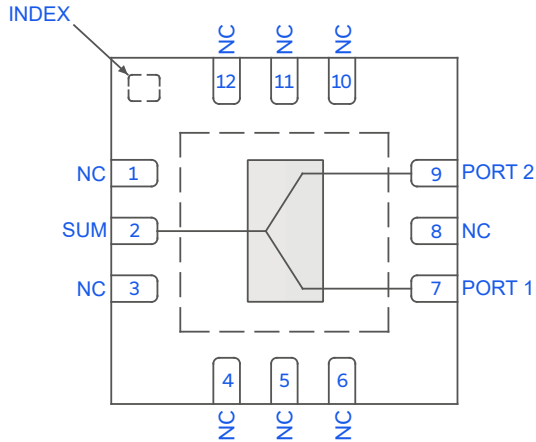

PAD DESCRIPTION

Function	Pad Number	Description (Refer to Figure 2)
SUM	2	SUM Pad connects to Input Sum Port.
PORT 1	7	PORT 1 Pad connects to Output Port 1.
PORT 2	9	PORT 2 Pad connects to Output Port 2.
NC	1, 3-6, 8, 10-12	Connects to ground on the test board.
GND	PADDLE & INDEX	Connects to ground.

Figure 1. GP2S1A+ Functional Diagram

CHARACTERIZATION TEST BOARD

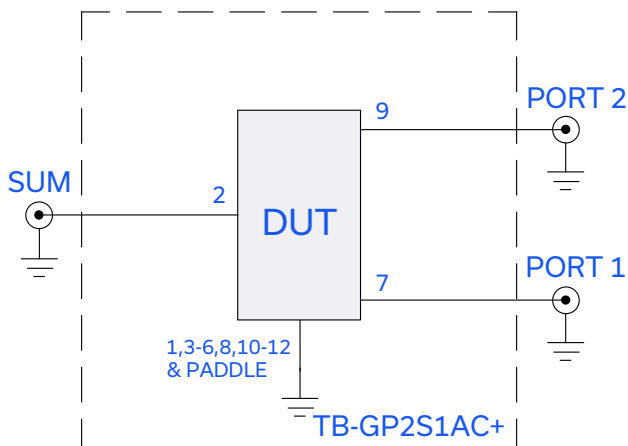

Figure 2. GP2S1A+ Characterization and Application Circuit.

Electrical Parameters and Conditions

Insertion Loss, Isolation, Return Loss, Phase Unbalance, and Amplitude Unbalance measured using N5242A PNA-X microwave network analyzer.

Condition:

1) Insertion Loss and Return Loss: $P_{IN} = -10$ dBm



CASE STYLE DRAWING

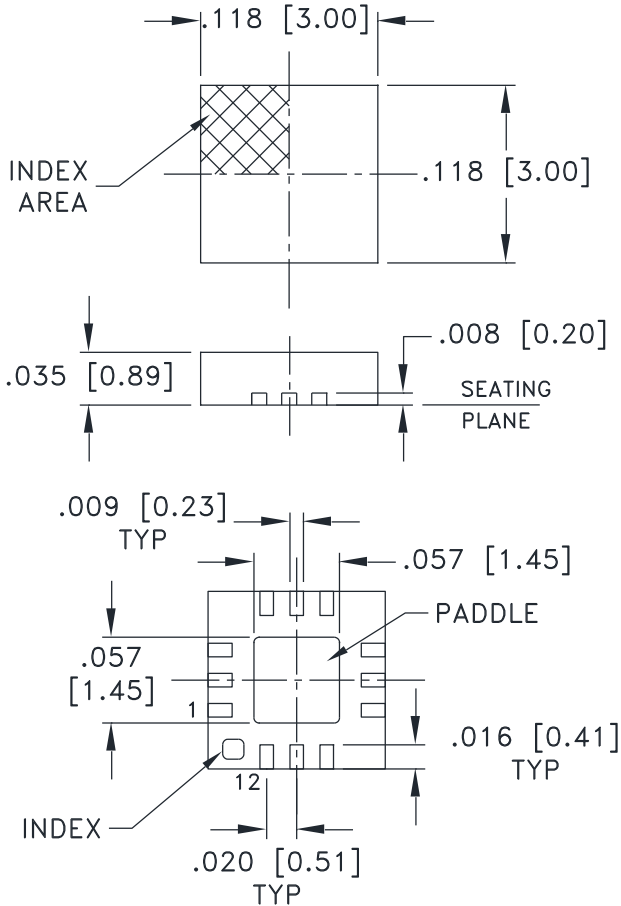

PCB Land Pattern

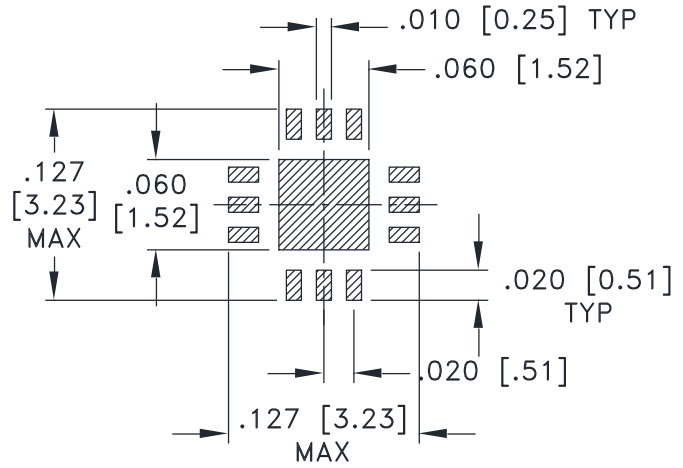

SUGGESTED LAYOUT,
TOLERANCE TO BE WITHIN ±.002

Weight: .02 Grams

Dimensions are in inches [mm]. Tolerances in inches: 2 Pl. ±.01; 3 Pl. ±.004 inches

PRODUCT MARKING

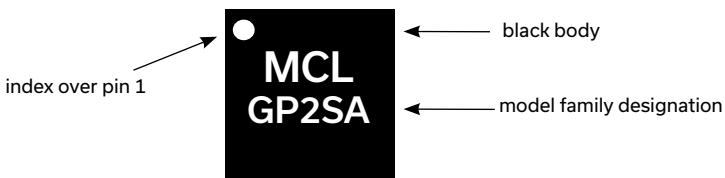

Marking may contain other features or characters for internal lot control



MMIC SURFACE MOUNT

Power Splitter/Combiner

GP2S1A+

50Ω 500 to 2500 MHz DC PASSING

ADDITIONAL DETAILED INFORMATION IS AVAILABLE ON OUR DASHBOARD [CLICK HERE](#)

Performance Data & Graphs	Data Graphs S-Parameter (S3P Files) Data Set (.zip file)
Case Style	DQ1225 Plastic package, exposed paddle, Lead Finish: Matte-Tin
RoHS Status	Compliant
Tape & Reel Standard quantities available on reel	F66 7" reels with 20, 50, 100, 200, 500, 1000, 2000, or 3000 devices
Suggested Layout for PCB Design	PL-817
Evaluation Board	TB-GP2S1AC+ Gerber File
Environmental Ratings	ENV12

NOTES

- A. Performance and quality attributes and conditions not expressly stated in this specification document are intended to be excluded and do not form a part of this specification document.
- B. Electrical specifications and performance data contained in this specification document are based on Mini-Circuit's applicable established test performance criteria and measurement instructions.
- C. The parts covered by this specification document are subject to Mini-Circuits standard limited warranty and terms and conditions (collectively, "Standard Terms"); Purchasers of this part are entitled to the rights and benefits contained therein. For a full statement of the standard terms and the exclusive rights and remedies thereunder, please visit Mini-Circuits' website at www.minicircuits.com/terms/viewterm.html



Looking for pricing, stock, or lifecycle information?

Click below to explore more details on WIN SOURCE:

 [View GP2S1A+ on WIN SOURCE](#)

 [Mini-Circuits Information](#)

Optimize Your Supply Chain with WIN SOURCE Solutions

-  Global Sourcing Solution
-  Obsolete Management
-  Cost Control Management
-  Shortage Management
-  Alternative Solution
-  Excess Inventory Management