

Coaxial

Power Splitter/Combiner

2 Way-0° 50Ω 10 to 2500 MHz

ZFSC-2-2500-S+



CASE STYLE: K18

Connectors Model
SMA ZFSC-2-2500-S+
BRACKET (OPTION "B")

+RoHS Compliant

The +Suffix identifies RoHS Compliance. See our web site for RoHS Compliance methodologies and qualifications

Maximum Ratings

Operating Temperature	-55°C to 100°C
Storage Temperature	-55°C to 100°C
Power Input (as a splitter)	1W max.
Internal Dissipation	0.125W max.

Permanent damage may occur if any of these limits are exceeded.

Coaxial Connections

SUM PORT	3
PORT 1	1
PORT 2	2

Features

- very wideband, 10 to 2500 MHz
- low insertion loss, 0.4 dB typ.
- excellent amplitude unbalance, 0.1 dB typ.
- excellent phase unbalance, 1.0 deg. typ.
- rugged shielded case

Applications

- cellular
- GPS
- PCS/DCS
- ISM
- satellite distribution

Electrical Specifications

FREQ. RANGE (MHz)	ISOLATION (dB)			INSERTION LOSS (dB) ABOVE 3.0 dB			PHASE UNBALANCE (Degrees)			AMPLITUDE UNBALANCE (dB)								
	L	M	U	L	M	U	L	M	U	L	M	U						
f _L -f _U	Typ.	Min.	Typ. Min.	Typ. Min.	Typ. Max.	Typ. Max.	Typ. Max.	Max.	Max.	Max.	Max.	Max.	Max.					
10-2500	16	11	17	14	17	14	0.5	0.8	0.6	1.4	0.8	1.5	1	4	8	0.2	0.3	0.4

L = low range [f_L to 10 f_L] M = mid range [10 f_L to f_U/2] U = upper range [f_U/2 to f_U]

Outline Drawing

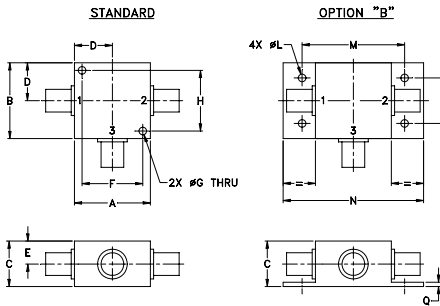

Outline Dimensions (inch/mm)

A	B	C	D	E	F	G	H
1.25	1.25	.75	.63	.38	1.00	.125	1.000
31.75	31.75	19.05	16.00	9.65	25.40	3.18	25.40

J	K	L	M	N	P	Q	wt
--	--	.125	1.688	2.18	.75	.07	grams
--	--	3.18	42.88	55.37	19.05	1.78	70.0

Typical Performance Data

Frequency (MHz)	Total Loss ¹ (dB)		Amplitude Unbalance (dB)	Isolation (dB)	Phase Unbalance (deg.)	VSWR S	VSWR 1	VSWR 2
	S-1	S-2						
10.00	3.53	3.53	0.00	20.79	0.01	1.99	1.66	1.66
50.00	3.55	3.55	0.00	21.35	0.02	1.98	1.66	1.66
100.00	3.56	3.56	0.00	21.52	0.04	1.98	1.67	1.67
200.00	3.58	3.58	0.00	21.59	0.06	1.96	1.66	1.66
400.00	3.60	3.60	0.00	21.19	0.11	1.93	1.64	1.64
700.00	3.59	3.59	0.00	19.97	0.19	1.84	1.58	1.59
1000.00	3.58	3.57	0.01	19.28	0.30	1.71	1.52	1.52
1200.00	3.57	3.55	0.01	19.08	0.40	1.62	1.47	1.47
1400.00	3.56	3.54	0.01	19.22	0.54	1.51	1.42	1.41
1600.00	3.55	3.53	0.02	19.90	0.70	1.41	1.36	1.34
1800.00	3.55	3.54	0.01	21.53	0.87	1.30	1.29	1.26
2000.00	3.55	3.56	0.01	25.39	1.06	1.19	1.20	1.16
2200.00	3.58	3.61	0.03	39.20	1.20	1.09	1.10	1.07
2400.00	3.64	3.69	0.05	26.21	1.19	1.01	1.02	1.02

1. Total Loss = Insertion Loss + 3dB splitter loss.

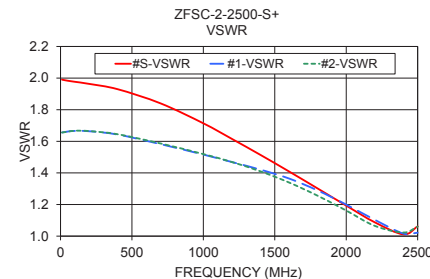
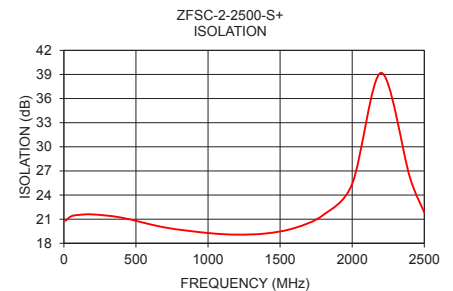
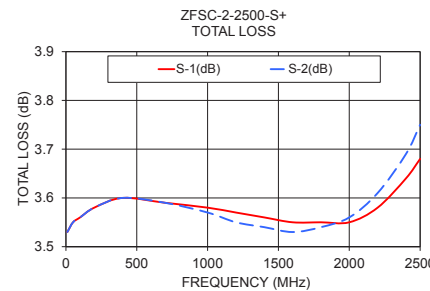

electrical schematic

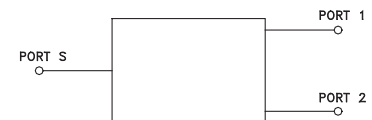



Notes

- Performance and quality attributes and conditions not expressly stated in this specification document are intended to be excluded and do not form a part of this specification document.
- Electrical specifications and performance data contained in this specification document are based on Mini-Circuit's applicable established test performance criteria and measurement instructions.
- The parts covered by this specification document are subject to Mini-Circuit's standard limited warranty and terms and conditions (collectively, "Standard Terms"); Purchasers of this part are entitled to the rights and benefits contained therein. For a full statement of the Standard Terms and the exclusive rights and remedies thereunder, please visit Mini-Circuit's website at www.minicircuits.com/MCLStore/terms.jsp



Looking for pricing, stock, or lifecycle information?

Click below to explore more details on WIN SOURCE:

-  [View ZFSC-2-2500-S+ on WIN SOURCE](#)
-  [Mini-Circuits Information](#)

Optimize Your Supply Chain with WIN SOURCE Solutions

-  Global Sourcing Solution
-  Obsolete Management
-  Cost Control Management
-  Shortage Management
-  Alternative Solution
-  Excess Inventory Management