

2 Way-0° 50Ω 1150 to 1950 MHz

## The Big Deal

- Exceptional amplitude unbalance, 0.05 dB typ. at 1550 MHz
- Good phase unbalance, 0.8 deg. typ.
- Tiny Size, 1.4 mm x 2.0 mm
- Excellent power handling, 1.5W



CASE STYLE: MC2601

## Product Overview

Mini-Circuits' NP2G+ is a MMIC 2-way 0° splitter/combiner designed for narrowband operation from 1150 to 1950 MHz supporting many applications requiring high performance across a narrowband frequency range including the GPS, Radar, mobile and radio navigation. This model provides excellent power handling up to 1.5W (as a splitter) with low insertion loss, good isolation, and low phase and amplitude unbalance in a tiny 1.4 x 2.0 mm, 6-Lead MCLP package. Manufactured using Silicon IPD\* process technology.

## Key Features

Feature	Advantages
Wide range of applications	One power splitter can be used in the GPS, Radar, mobile and radio navigation.
Tiny size, 1.4 x 2.0 mm, 6-Lead MCLP package	Tiny foot print saves space in dense layouts while providing low inductance, repeatable transitions, and excellent thermal contact to the PCB.
Good Isolation, 19 dB typ. 1400 to 1650 MHz	Minimizes interference between input ports.

\*IPD (Integrated passive device)

# Power Splitter/Combiner

2 Way-0° 50Ω 1150 to 1950 MHz

### Features

- Excellent amplitude unbalance, 0.05 dB typ. at 1550 MHz
- Good phase unbalance, 0.8 deg. typ.
- Small size, 1.4mm x 2.0mm
- Aqueous washable

### Applications

- GPS
- Radar
- Mobile
- Radio navigation



CASE STYLE: MC2601

### +RoHS Compliant

The +Suffix identifies RoHS Compliance. See our web site for RoHS Compliance methodologies and qualifications

### Electrical Specifications<sup>1</sup> at 25°C

Parameter	Frequency (MHz)	Min.	Typ.	Max.	Unit
Frequency Range		1150		1950	MHz
Insertion Loss above 3.0 dB	1150 - 1950	—	0.4	1.1	dB
	1400 - 1650	—	0.3	0.9	
Isolation	1150 - 1950	9	20	—	dB
	1400 - 1650	18	29	—	
Phase Unbalance	1150 - 1950	—	0.8	4	Degree
	1400 - 1650	—	0.6	4	
Amplitude Unbalance	1150 - 1950	—	0.1	0.4	dB
	1400 - 1650	—	0.1	0.4	
VSWR (Input)	1150 - 1950	—	1.3	—	dB
	1400 - 1650	—	1.2	—	
VSWR (Output)	1150 - 1950	—	1.3	—	dB
	1400 - 1650	—	1.2	—	

1. Tested on Mini-Circuits Test Board TB-1059+

### Maximum Ratings

Parameter	Ratings
Operating Temperature	-40°C to 85°C
Storage Temperature	-65°C to 150°C
Power Input (as a splitter)	1.5W at 25°C
Internal Dissipation (as a combiner)	0.75W at 25°C

Permanent damage may occur if any of these limits are exceeded

### Pad Connections

Function	Pad Number
SUM PORT	2
PORT 1	4
PORT 2	6
GND	1,3,5

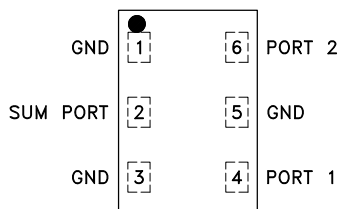

### Simplified Electrical Schematic

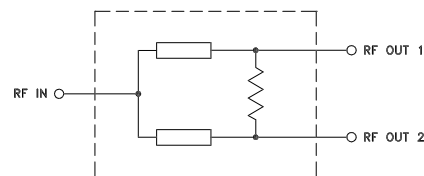

Typical Performance Data

Frequency (MHz)	Total Loss <sup>1</sup> (dB)		Amplitude Unbalance (dB)	Isolation (dB)	Phase Unbalance (deg.)	VSWR S	VSWR 1	VSWR 2
	S-1	S-2						
1150	3.50	3.40	0.03	12.00	0.20	1.42	1.21	1.21
1200	3.50	3.40	0.02	13.30	0.20	1.38	1.16	1.16
1300	3.40	3.40	0.02	16.70	0.20	1.32	1.08	1.09
1400	3.40	3.40	0.01	22.40	0.30	1.25	1.07	1.09
1450	3.40	3.40	0.01	27.70	0.40	1.23	1.11	1.12
1500	3.40	3.40	0.01	41.70	0.40	1.21	1.15	1.15
1550	3.40	3.40	0.01	32.00	0.50	1.20	1.20	1.20
1600	3.40	3.40	0.01	24.90	0.50	1.20	1.25	1.24
1650	3.50	3.50	0.01	21.20	0.60	1.21	1.30	1.29
1700	3.50	3.50	0.01	18.70	0.60	1.24	1.35	1.33
1800	3.50	3.50	0.02	15.30	0.70	1.33	1.46	1.43
1900	3.60	3.60	0.05	12.90	0.80	1.45	1.56	1.51
1950	3.70	3.70	0.07	12.00	0.80	1.53	1.61	1.55

1. Total Loss = Insertion Loss + 3dB splitter loss.

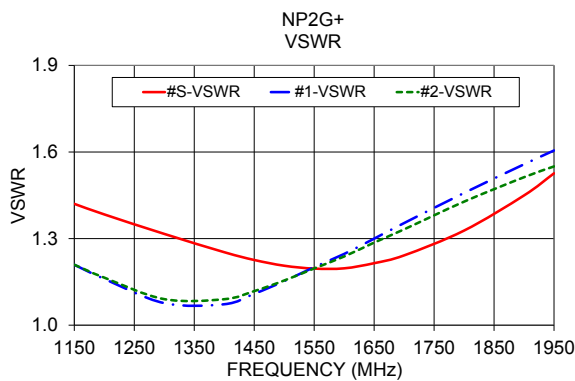
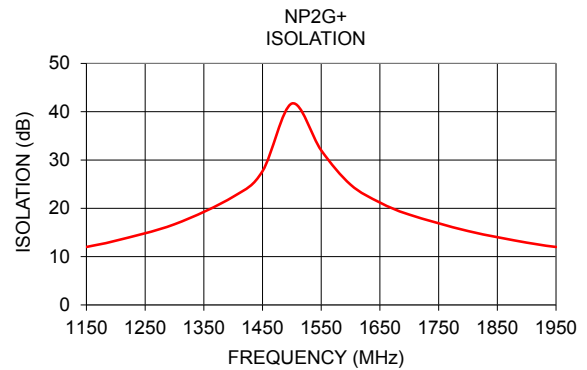
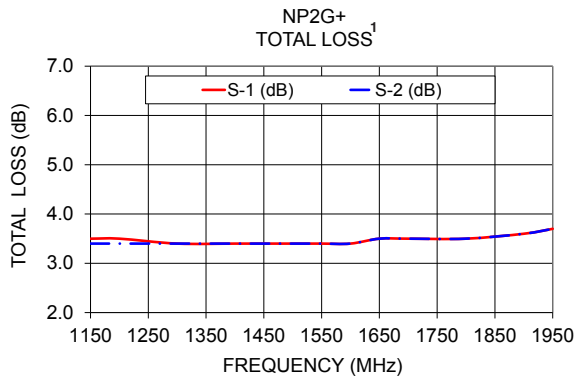

<b>Additional Detailed Technical Information</b> <i>additional information is available on our dash board. To access this information <a href="#">click here</a></i>	
<b>Performance Data</b>	Data Table
	Swept Graphs
	S-Parameter (S3P Files) Data Set (.zip file)
<b>Case Style</b>	MC2601 <i>Plastic package, exposed paddle</i> <i>lead finish: Matte Tin</i>
<b>Tape &amp; Reel</b> Standard quantities available on reel	F104 <i>7" reels with 20, 50, 100, 200, 500, 1000 and 2000 devices</i>
<b>Suggested Layout for PCB Design</b>	PL-609
<b>Evaluation Board</b>	TB-1059+
<b>Environmental Ratings</b>	ENV12

**ESD Rating**

Human Body Model (HBM): Class 1 (250 to <500V) in accordance with ANSI/ESD STM 5.1 - 2001

**MCL Rating**

Moisture Sensitivity: MSL1 in accordance with IPC/JEDEC J-STD-020D

**MSL Test Flow Chart**

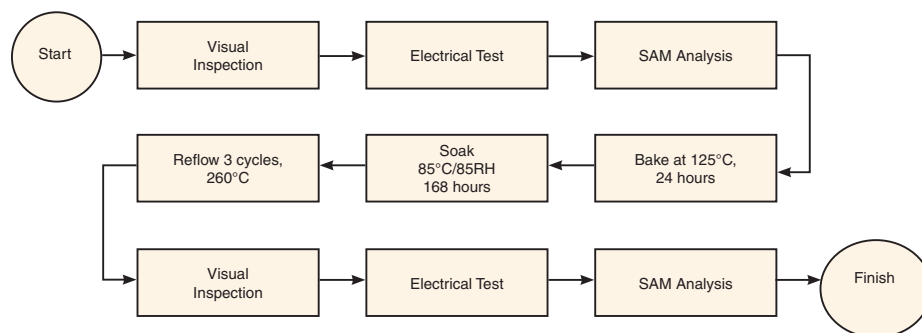



**Additional Notes**

- A. Performance and quality attributes and conditions not expressly stated in this specification document are intended to be excluded and do not form a part of this specification document.
- B. Electrical specifications and performance data contained in this specification document are based on Mini-Circuit's applicable established test performance criteria and measurement instructions.
- C. The parts covered by this specification document are subject to Mini-Circuits standard limited warranty and terms and conditions (collectively, "Standard Terms"); Purchasers of this part are entitled to the rights and benefits contained therein. For a full statement of the Standard Terms and the exclusive rights and remedies thereunder, please visit Mini-Circuits' website at [www.minicircuits.com/MCLStore/terms.jsp](http://www.minicircuits.com/MCLStore/terms.jsp)



## Looking for pricing, stock, or lifecycle information?

Click below to explore more details on WIN SOURCE:

-  [View NP2G+ on WIN SOURCE](#)
-  [Mini-Circuits Information](#)

## Optimize Your Supply Chain with WIN SOURCE Solutions

-  Global Sourcing Solution
-  Obsolete Management
-  Cost Control Management
-  Shortage Management
-  Alternative Solution
-  Excess Inventory Management