



SiGe HBT GAIN BLOCK MMIC AMPLIFIER, DC - 4 GHz

Typical Applications

The HMC478MP86 / HMC478MP86E is an ideal RF/IF gain block & LO or PA driver:

- Cellular / PCS / 3G
- Fixed Wireless & WLAN
- CATV, Cable Modem & DBS
- Microwave Radio & Test Equipment

Features

- P1dB Output Power: +18 dBm
- Gain: 22 dB
- Output IP3: +32 dBm
- Cascadable 50 Ohm I/Os
- Single Supply: +5V to +8V
- Robust 1,000V ESD, Class 1C
- Included in the HMC-DK001 Designer's Kit

Functional Diagram

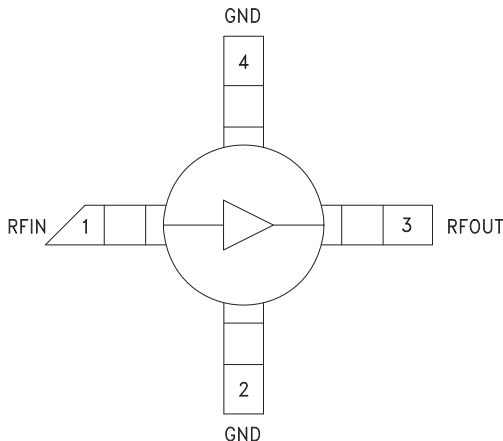

General Description

The HMC478MP86 & HMC478MP86E are SiGe Heterojunction Bipolar Transistor (HBT) Gain Block MMIC SMT amplifiers covering DC to 4 GHz. This Micro-P packaged amplifier can be used as a cascadable 50 Ohm RF/IF gain stage as well as a LO or PA driver with up to +20 dBm output power. The HMC478MP86(E) offers 22 dB of gain with a +32 dBm output IP3 at 850 MHz while requiring only 62 mA from a single positive supply. The Darlington feedback pair used results in reduced sensitivity to normal process variations and excellent gain stability over temperature while requiring a minimal number of external bias components.

Electrical Specifications, $V_s = 5V$, $R_{bias} = 18 \text{ Ohm}$, $T_A = +25^\circ \text{ C}$

Parameter		Min.	Typ.	Max.	Units
Gain	DC - 1.0 GHz	19	22		dB
	1.0 - 2.0 GHz	15	18		dB
	2.0 - 3.0 GHz	13	16		dB
	3.0 - 4.0 GHz	11	14		dB
Gain Variation Over Temperature	DC - 4 GHz		0.015	0.02	dB/ °C
Input Return Loss	DC - 1.0 GHz		15		dB
	1.0 - 3.0 GHz		12		dB
	3.0 - 4.0 GHz		13		dB
Output Return Loss	DC - 1.0 GHz		20		dB
	1.0 - 4.0 GHz		17		dB
Reverse Isolation	DC - 4 GHz		20		dB
Output Power for 1 dB Compression (P1dB)	0.5 - 1.0 GHz	15	18		dBm
	1.0 - 2.0 GHz	13	16		dBm
	2.0 - 3.0 GHz	11	14		dBm
	3.0 - 4.0 GHz	9	12		dBm
Output Third Order Intercept (IP3) (Pout= 0 dBm per tone, 1 MHz spacing)	0.5 - 2.0 GHz		32		dBm
	2.0 - 3.0 GHz		29		dBm
	3.0 - 4.0 GHz		25		dBm
Noise Figure	DC - 3.0 GHz		2.5		dB
	3.0 - 4.0 GHz		3.5		dB
Supply Current (Icq)			62		mA

Note: Data taken with broadband bias tee on device output.

Information furnished by Analog Devices is believed to be accurate and reliable. However, no responsibility is assumed by Analog Devices for its use, nor for any infringements of patents or other rights of third parties that may result from its use. Specifications subject to change without notice. No license is granted by implication or otherwise under any patent or patent rights of Analog Devices. Trademarks and registered trademarks are the property of their respective owners.

For price, delivery, and to place orders: Analog Devices, Inc., One Technology Way, P.O. Box 9106, Norwood, MA 02062-9106
Phone: 781-329-4700 • Order online at www.analog.com
Application Support: Phone: 1-800-ANALOG-D



**SiGe HBT GAIN BLOCK
MMIC AMPLIFIER, DC - 4 GHz**

Broadband Gain & Return Loss

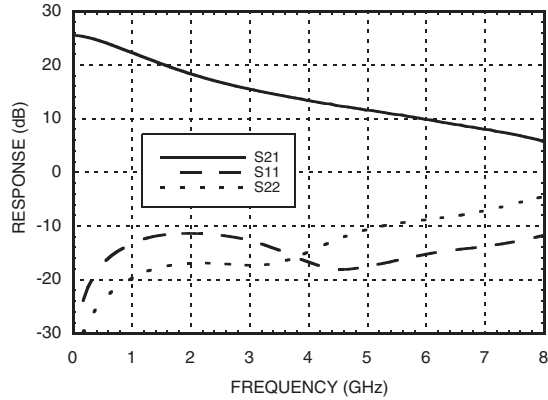

Gain vs. Temperature

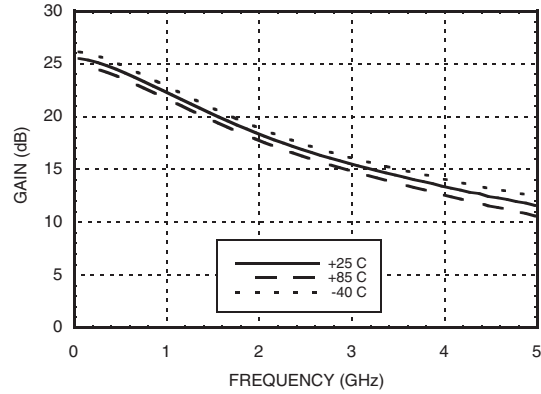

Input Return Loss vs. Temperature

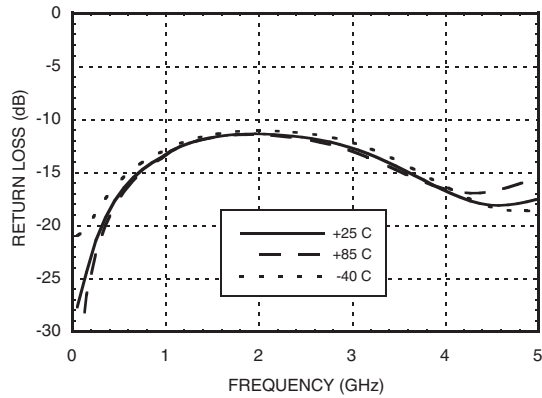

Output Return Loss vs. Temperature

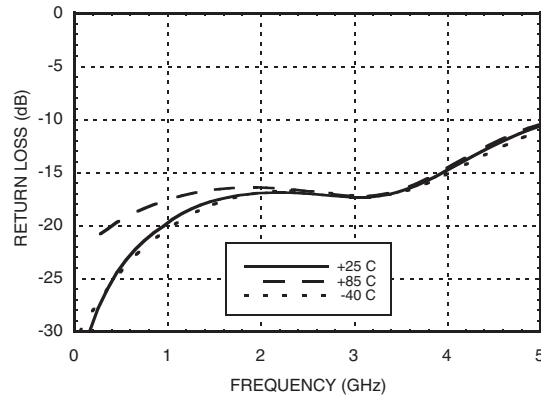

Reverse Isolation vs. Temperature

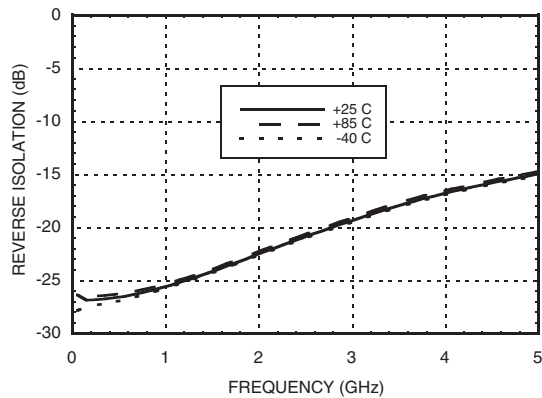

Noise Figure vs. Temperature

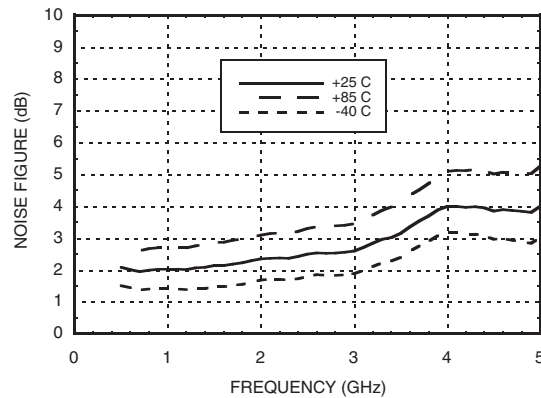

Information furnished by Analog Devices is believed to be accurate and reliable. However, no responsibility is assumed by Analog Devices for its use, nor for any infringements of patents or other rights of third parties that may result from its use. Specifications subject to change without notice. No license is granted by implication or otherwise under any patent or patent rights of Analog Devices. Trademarks and registered trademarks are the property of their respective owners.

For price, delivery, and to place orders: Analog Devices, Inc., One Technology Way, P.O. Box 9106, Norwood, MA 02062-9106 Phone: 781-329-4700 • Order online at www.analog.com Application Support: Phone: 1-800-ANALOG-D



**SiGe HBT GAIN BLOCK
MMIC AMPLIFIER, DC - 4 GHz**

P1dB vs. Temperature

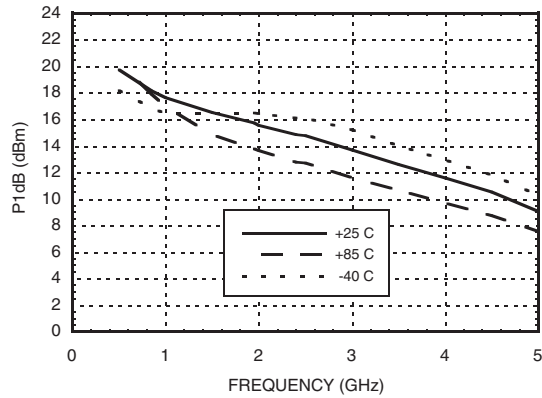

Psat vs. Temperature

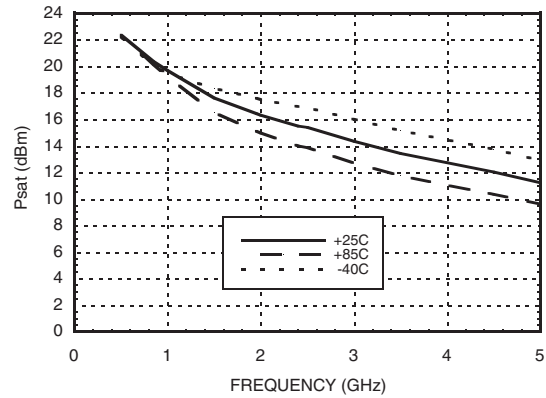

Output IP3 vs. Temperature

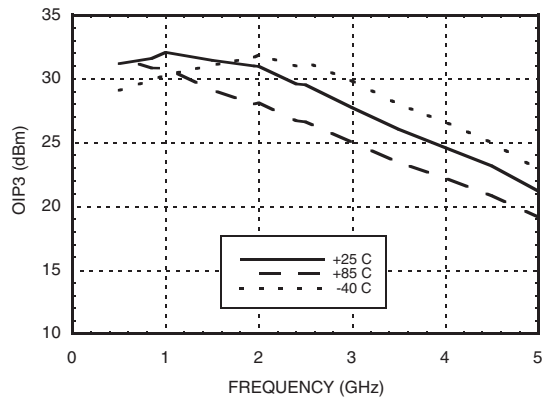

Gain, Power & OIP3 vs. Supply Voltage for Constant Icc= 62 mA @ 850 MHz

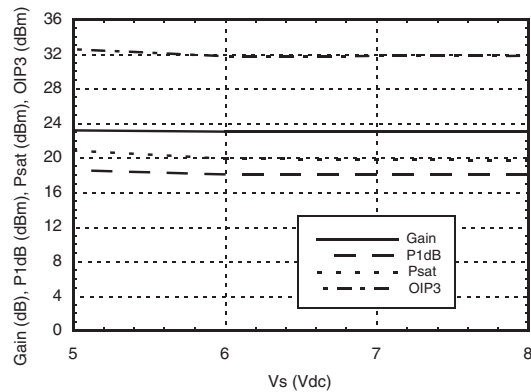

Vcc vs. Icc Over Temperature for Fixed Vs= 5V, RBIAS= 18 Ohms

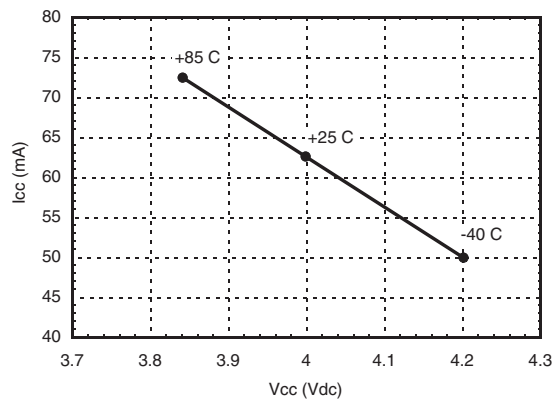

Gain, Power & OIP3 vs. Supply Voltage for Rs = 18 Ohms @ 850 MHz

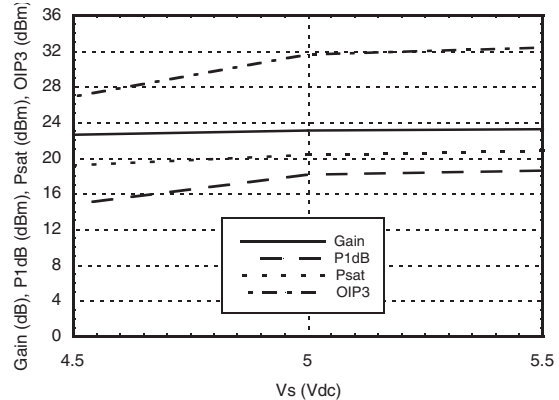

Information furnished by Analog Devices is believed to be accurate and reliable. However, no responsibility is assumed by Analog Devices for its use, nor for any infringements of patents or other rights of third parties that may result from its use. Specifications subject to change without notice. No license is granted by implication or otherwise under any patent or patent rights of Analog Devices. Trademarks and registered trademarks are the property of their respective owners.

For price, delivery, and to place orders: Analog Devices, Inc., One Technology Way, P.O. Box 9106, Norwood, MA 02062-9106 Phone: 781-329-4700 • Order online at www.analog.com Application Support: Phone: 1-800-ANALOG-D

SiGe HBT GAIN BLOCK MMIC AMPLIFIER, DC - 4 GHz



Absolute Maximum Ratings

Collector Bias Voltage (Vcc)	+6.0 Vdc
Collector Bias Current (Icc)	100 mA
RF Input Power (RFIN)(Vcc = +4.3 Vdc)	+5 dBm
Junction Temperature	150 °C
Continuous P _{diss} (T = 85 °C) (derate 9 mW/°C above 85 °C)	0.583 W
Thermal Resistance (junction to lead)	111.5 °C/W
Storage Temperature	-65 to +150 °C
Operating Temperature	-40 to +85 °C
ESD Sensitivity (HBM)	Class 1C



ELECTROSTATIC SENSITIVE DEVICE
OBSERVE HANDLING PRECAUTIONS

8

AMPLIFIERS - DRIVER & GAIN BLOCK - SMT

Outline Drawing

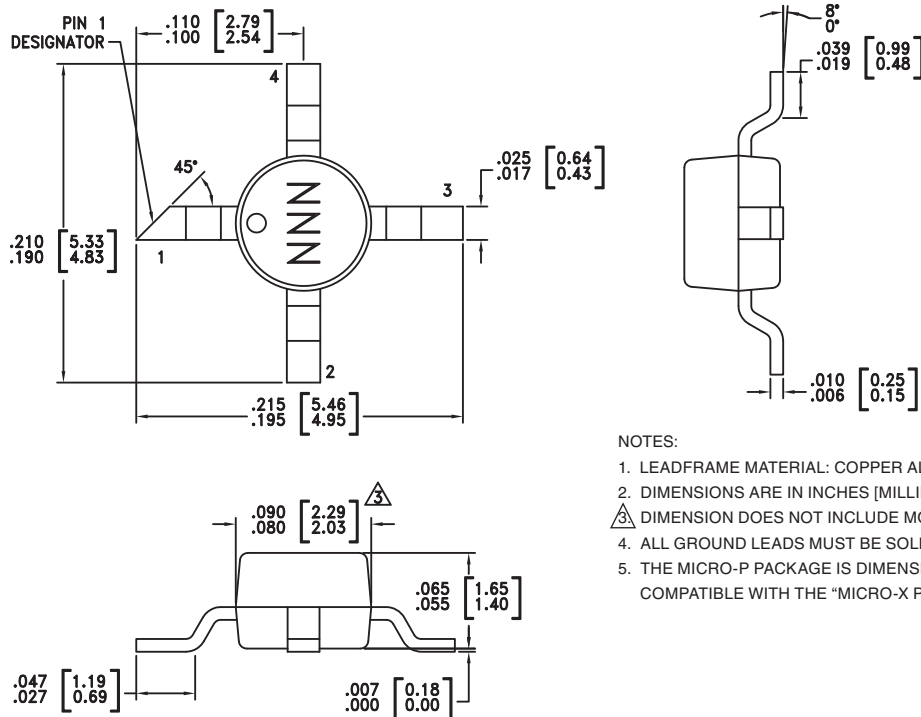

NOTES:

- LEADFRAME MATERIAL: COPPER ALLOY
- DIMENSIONS ARE IN INCHES [MILLIMETERS]
- Δ DIMENSION DOES NOT INCLUDE MOLDFLASH OF 0.15mm PER SIDE.
- ALL GROUND LEADS MUST BE SOLDERED TO PCB RF GROUND.
- THE MICRO-P PACKAGE IS DIMENSIONALLY COMPATIBLE WITH THE "MICRO-X PACKAGE"

Package Information

Part Number	Package Body Material	Lead Finish	MSL Rating	Package Marking
HMC478MP86	Low Stress Injection Molding Plastic	Sn/Pb Solder	MSL1 [1]	478
HMC478MP86E	RoHS-compliant Low Stress Injection Molding Plastic	100% matte Sn	MSL1 [2]	478

[1] Max peak reflow temperature of 235 °C
[2] Max peak reflow temperature of 260 °C



Pin Descriptions

Pin Number	Function	Description	Interface Schematic
1	RFIN	This pin is DC coupled. An off chip DC blocking capacitor is required.	
3	RFOUT	RF output and DC Bias (Vcc) for the output stage.	
2, 4	GND	These pins must be connected to RF/DC ground.	

Application Circuit

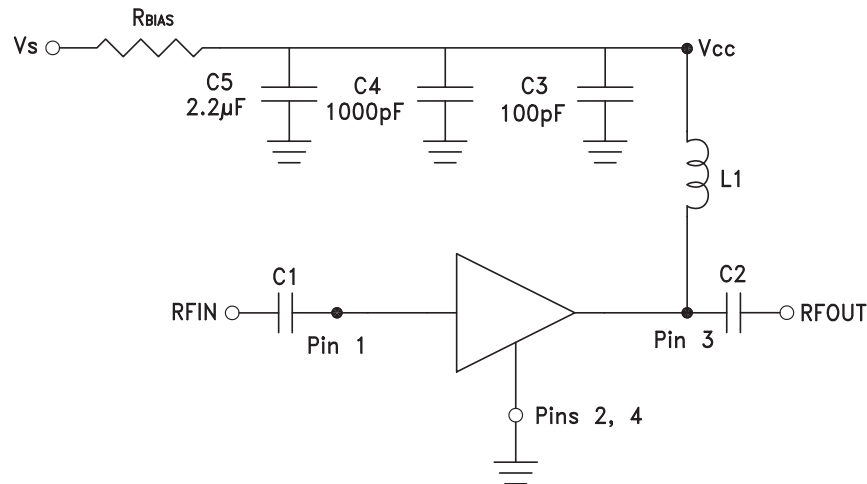

Recommended Bias Resistor Values for $I_{cc} = 62 \text{ mA}$, $R_{bias} = (V_s - V_{cc}) / I_{cc}$

Supply Voltage (Vs)	5V	6V	8V
RBIAS VALUE	18 Ω	35 Ω	67 Ω
RBIAS POWER RATING	1/8 W	1/4 W	1/2 W

Note:

- External blocking capacitors are required on RFIN and RFOUT.
- RBIAS provides DC bias stability over temperature.

Recommended Component Values for Key Application Frequencies

Component	Frequency (MHz)					
	50	900	1900	2200	2400	3500
L1	270 nH	56 nH	18 nH	18 nH	15 nH	8.2 nH
C1, C2	0.01 μF	100 pF	100 pF	100 pF	100 pF	100 pF

Information furnished by Analog Devices is believed to be accurate and reliable. However, no responsibility is assumed by Analog Devices for its use, nor for any infringements of patents or other rights of third parties that may result from its use. Specifications subject to change without notice. No license is granted by implication or otherwise under any patent or patent rights of Analog Devices. Trademarks and registered trademarks are the property of their respective owners.

For price, delivery, and to place orders: Analog Devices, Inc., One Technology Way, P.O. Box 9106, Norwood, MA 02062-9106
Phone: 781-329-4700 • Order online at www.analog.com
Application Support: Phone: 1-800-ANALOG-D



**SiGe HBT GAIN BLOCK
MMIC AMPLIFIER, DC - 4 GHz**

Evaluation PCB

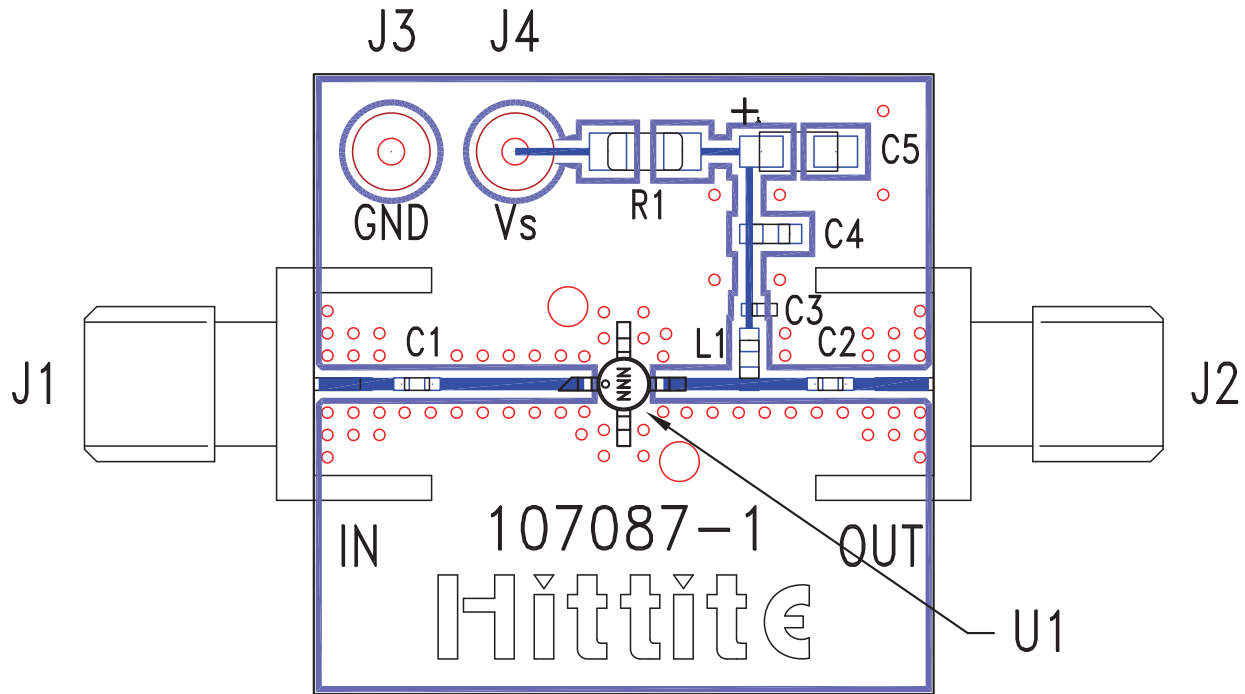

List of Materials for Evaluation PCB 110170 [1]

Item	Description
J1 - J2	PCB Mount SMA Connector
J3 - J4	DC Pin
C1, C2	Capacitor, 0402 Pkg.
C3	100 pF Capacitor, 0402 Pkg.
C4	1000 pF Capacitor, 0603 Pkg.
C5	2.2 μ F Capacitor, Tantalum
R1	Resistor, 1210 Pkg.
L1	Inductor, 0603 Pkg.
U1	HMC478MP86 / HMC478MP86E
PCB [2]	107087 Evaluation PCB

[1] Reference this number when ordering complete evaluation PCB

[2] Circuit Board Material: Rogers 4350

The circuit board used in the application should use RF circuit design techniques. Signal lines should have 50 Ohm impedance while the package ground leads should be connected directly to the ground plane similar to that shown. A sufficient number of via holes should be used to connect the top and bottom ground planes. The evaluation board should be mounted to an appropriate heat sink. The evaluation circuit board shown is available from Hittite upon request.

Looking for pricing, stock, or lifecycle information?

Click below to explore more details on WIN SOURCE:

⊖ [View HMC478MP86TR on WIN SOURCE](#)

⊖ [Analog Devices Inc. Information](#)

Optimize Your Supply Chain with WIN SOURCE Solutions

- ✓ Global Sourcing Solution
- ✓ Obsolete Management
- ✓ Cost Control Management
- ✓ Shortage Management
- ✓ Alternative Solution
- ✓ Excess Inventory Management