

Product Overview

The QPL1810 is a GaAs pHEMT single ended RF amplifier IC featuring 20dB of flat gain and low noise. This IC is designed to support Fiber to The Home (FTTH) applications from 50 to 1800MHz using a single 5V supply, or it can be used from 5V to 8V depending on linearity requirements. QPL1810 is packaged in a SOT-89 package for convenient layout and design in set top and infrastructure projects for 75 Ω CATV and satellite applications.

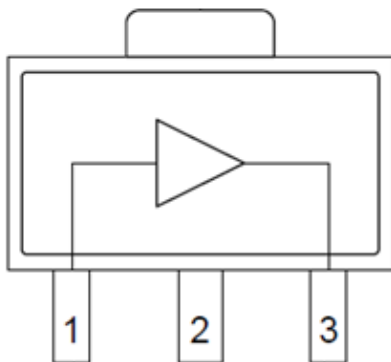

Functional Block Diagram



Top View

Key Features

- 50 MHz to 1800 MHz Operation
- 5 V to 8 V Operation
- Gain: 20 dB Typical
- Noise Figure: 1.5 dB Typical at 850 MHz
- Adjustable Bias Using External Resistors
- Convenient SOT-89 Package
- RoHS Compliant

Applications

- FTTH GPON and GEPON
- DOCSIS 4.0
- Head End CMTS Equipment
- Optical Node
- Satellite Low Noise Amplifier
- Cable Modem and Set Top Box
- Single Ended Gain Block

Ordering Information

Part Number	Description
QPL1810SB	Sample bag with 5 pieces
QPL1810SR	7" Reel with 100 pieces
QPL1810TR13	13" Reel with 2500 pieces
QPL1810EVB-01	Evaluation Board

Absolute Maximum Ratings

Parameter	Rating
Supply Voltage (V_{DD})	+10 V
Supply Current (I_{DD})	140 mA
Maximum Input Level	65 dBmV
Operating Temperature Range	-40 to +85 °C
Storage Temperature Range	-65 to +150 °C
Maximum Junction Temperature	+150 °C

Exceeding any one or a combination of the Absolute Maximum Rating conditions may cause permanent damage to the device. Extended application of Absolute Maximum Rating conditions to the device may reduce device reliability.

Electrical Specifications at +5V

Parameter	Condition ⁽¹⁾	Min	Typ	Max	Unit
Supply Voltage (V_{DD})			5		V
Supply Current (I_{DD})			61		mA
Frequency Range		50		1800	MHz
Gain			20		dB
Gain Slope			1		dB
Reverse Isolation			23		dB
Input Return Loss			18		dB
Output Return Loss			16		dB
Noise Figure			1.2		dB
OIP2	3 dBm / tone output		46		dBm
OIP3	7 dBm / tone output		35		dBm
OP1dB			20		dBm
Thermal Resistance	Θ_{JC}		35		°C/W

Note: Typical performance at these conditions: Temp = +25 °C, V_{DD} = +5V, 75 Ω system, Full band unless otherwise noted

Electrical Specifications at +8V

Parameter	Condition ⁽¹⁾	Min	Typ	Max	Unit
Supply Voltage (V _{DD})			8		V
Supply Current (I _{DD})			102		mA
Frequency Range		50		1800	MHz
Gain			20		dB
Gain Slope			1.0		dB
Reverse Isolation			23		dB
Input Return Loss			17		dB
Output Return Loss			16		dB
Noise Figure			1.5		dB
MER ⁽²⁾	At 255MHz		46		dB
At +55dBmV Total Composite Output power	At 1245MHz		44		dB
	At 1791MHz		42		dB
OIP2L	3 dBm / tone output		50		dBm
OIP3	7 dBm / tone output		40		dBm
OP1dB			24.2		dBm
Thermal Resistance	Θ _{JC}		35		°C/W

1. Typical performance at these conditions: Temp = +25 °C, V_{DD} = +8 V, 75 Ω system, Full band unless otherwise noted

2. 54MHz to 1794MHz, 0dB tilt, 1 OFDM (54-246MHz) + 254 QAM (252-1794MHz) Channels. CCN Noise BW (ANSI/SCTE 17): 5.36MHz for J.83/B. Tx Data: ITU-T, Annex B, QAM256, 5.36 MSymbols/s

Evaluation Board Schematic 50 MHz – 1800 MHz

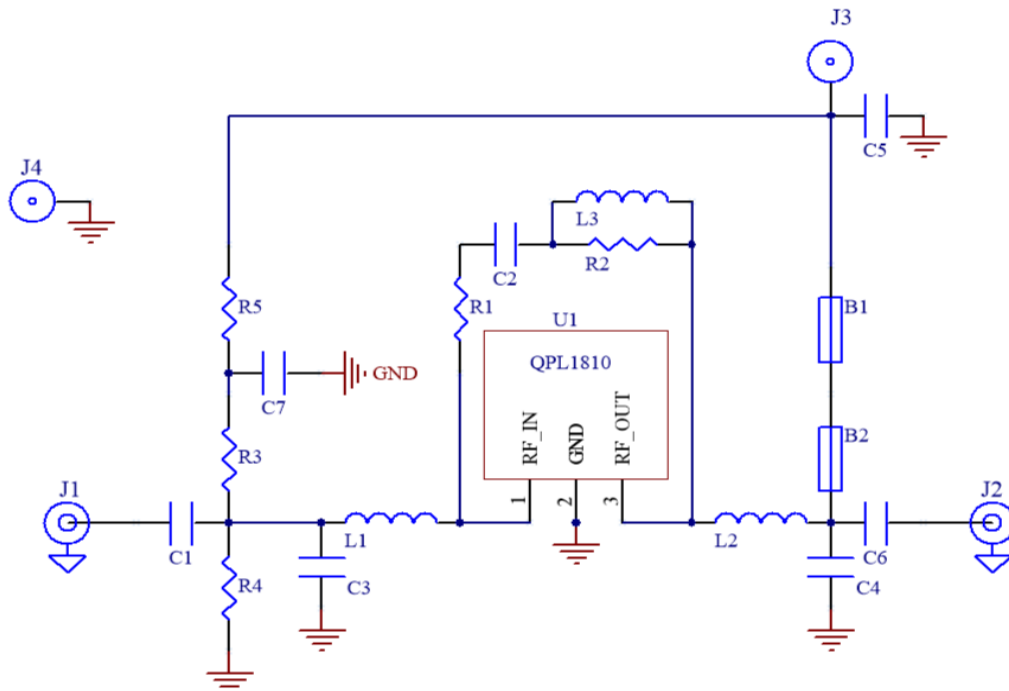

Evaluation Board Bill of Materials

Designator	Description	Manufacturer	Part Number
PCB	QPL1810-4000	DDI	QPL1810-4000(A)
U1	20dB FTTH Amplifier	Qorvo	QPL1810SB
B1	RES, 0 Ω, 5%, 1/10W, 0402	Kamaya, Inc	RMC1/16SJPTH
B2, R5	FER, BEAD, 1.8K, 200mA, 0402	TDK	MMZ1005A182ET000
C1, C2, C5	CAP, 0.01uF, 10%, 50V, X7R, 0402	Murata Electronics	GRM155R71H103KA88D
C3	CAP, 0.6pF, +/-0.1pF, 50V, HI-Q, 0402	Murata Electronics	GJM1555C1HR60BB01D
C4	CAP, 0.3pF, +/-0.05pF, 50V, C0G, 0402	Murata Electronics	GRM1555C1HR30WA01D
C6	CAP, 330pF, 5%, 50V, C0G, 0402	Murata Electronics	GRM1555C1H331JA01D
C7	CAP, 4.7pF, +/-0.25pF, 50V, HI-Q, 0402	Murata Electronics	GJM1555C1H4R7CB01D
J1, J2	CONN, F FEM EDGE MOUNT, 75 OHMS, 0.068"	Millimeter Wave Tech	MW-846-C-DD-75
J3, J4	TERM. SOLDER TURRET, 0.062 PCB	Mill-Max Manufacturing	2533-0-00-44-00-00-07-0
L1	IND, 5.6nH, +/- 0.3nH, 0402	Murata Electronics	LQG15HN5N6S02
L2	IND, 4.7nH, +/- 0.3nH, 0402	Murata Electronics	LQG15HN4N7S02
L3	IND, 18nH, 5%, 0402	Murata Electronics	LQG15HN18NJ02
R1	RES, 910 Ω, 5%, 1/16W, 0402	Panasonic Industrial	ERJ-2GEJ911X
R2	RES, 150 OHM, 5%, 1/16W, 0402	Kamaya, Inc	RMC1/16S-151JTH
R3	RES, 510 KΩ, 1/10W, 0402	Kamaya, Inc	RMC1/16S-514JTH
R4	Not Populated		

Evaluation Board Assembly Drawing

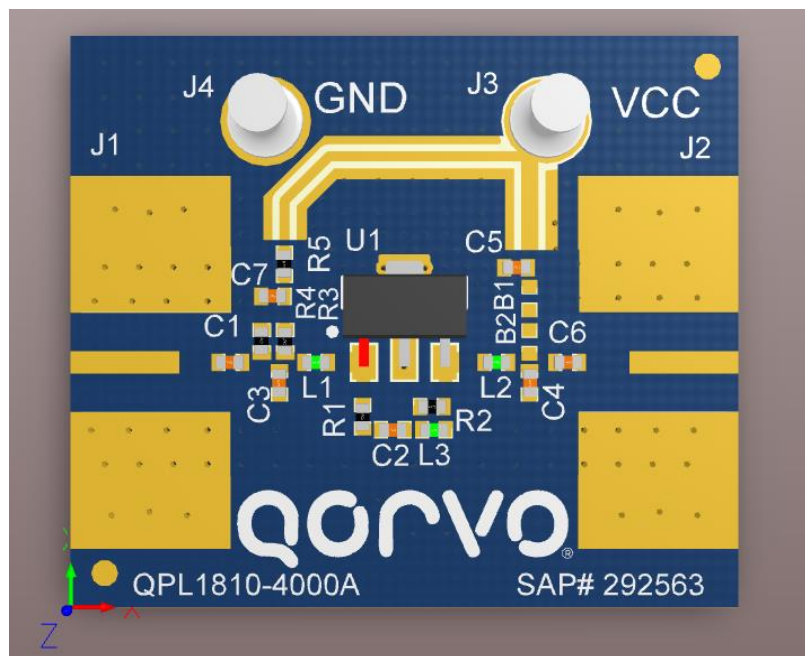

Performance Data at +5 V

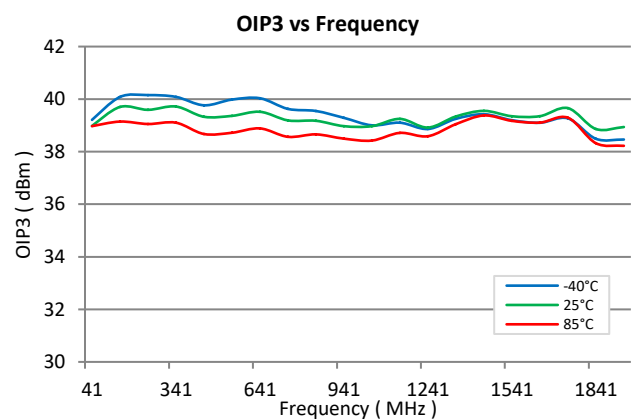
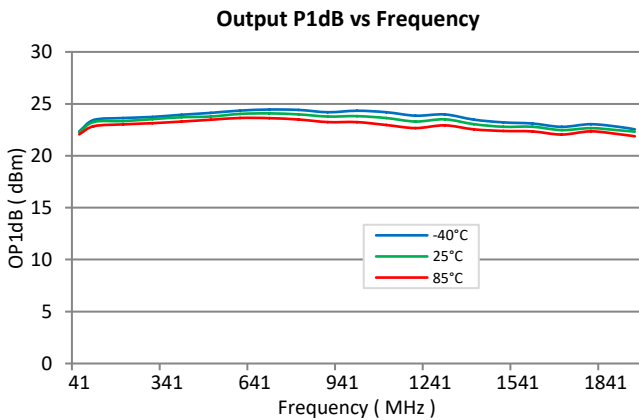
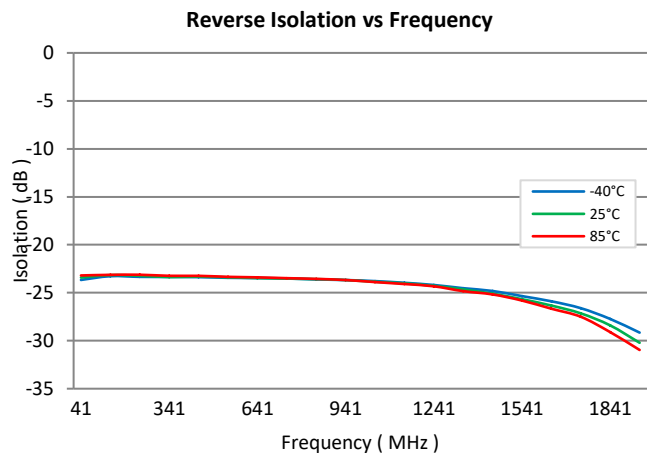
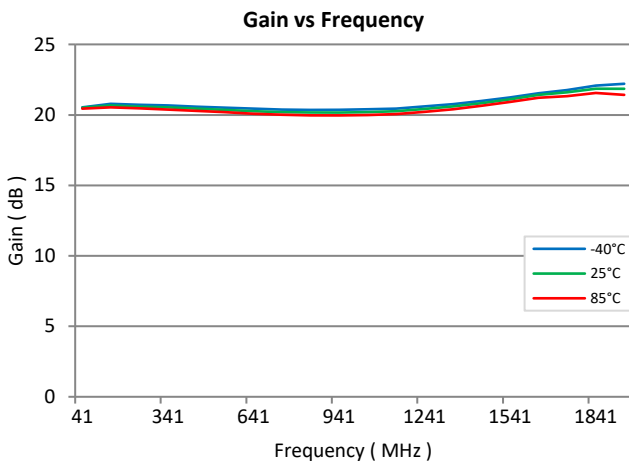
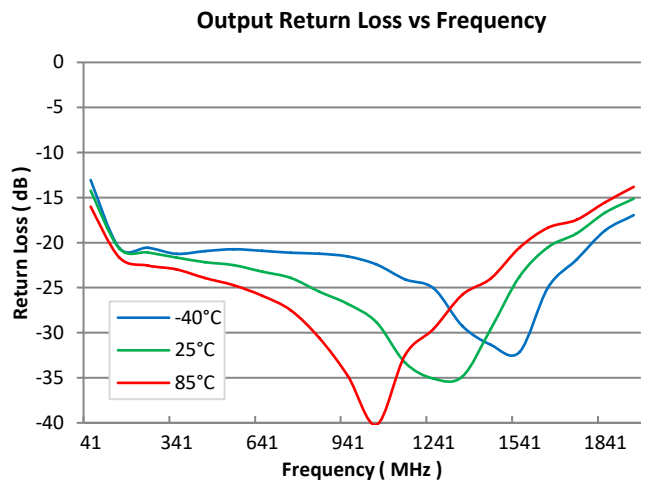
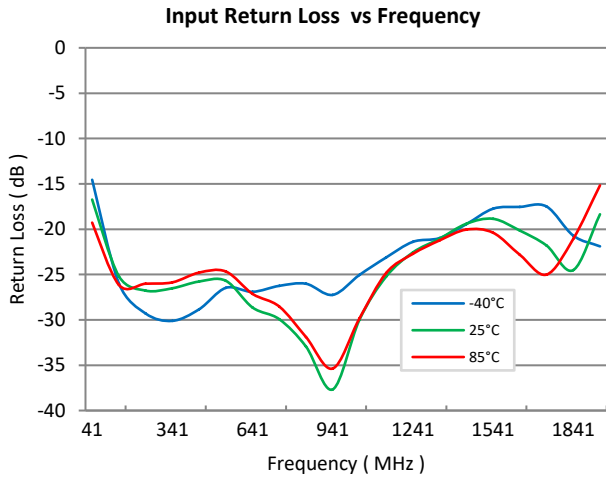

Notes: (1) OIP3: 7 dBm/tone output

Performance Data at +5 V

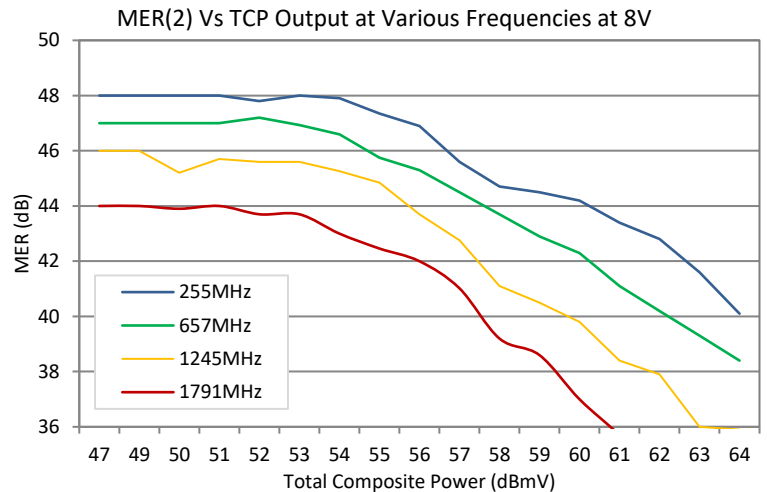
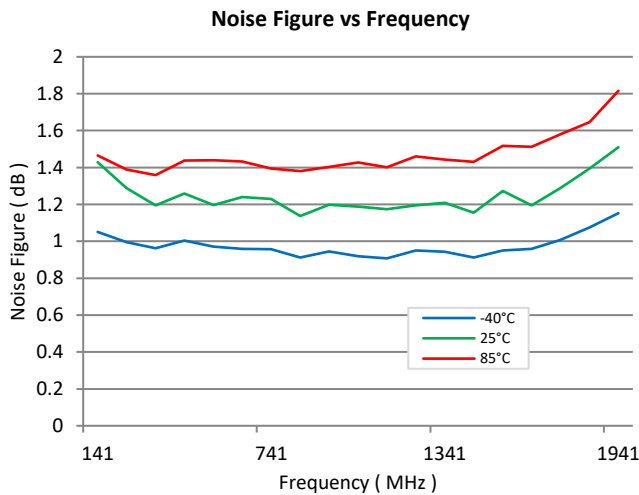
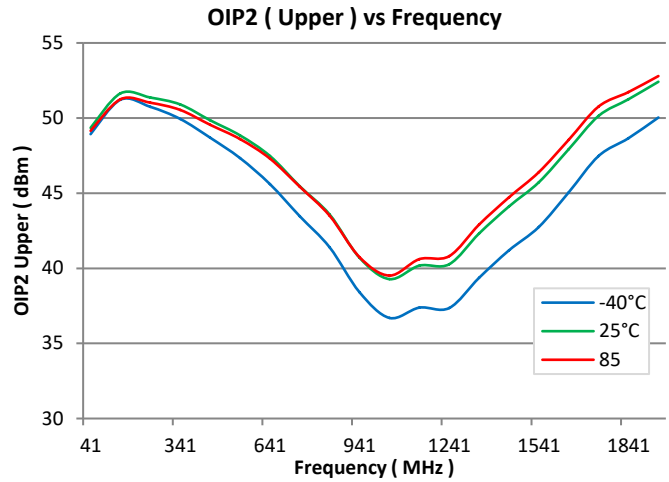
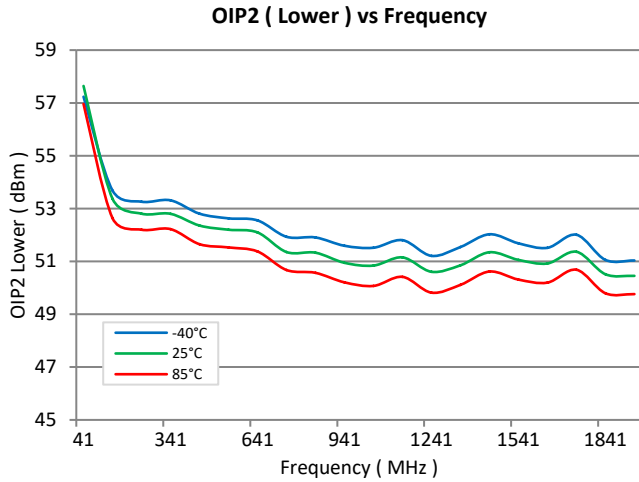

- Notes:
- (1) OIP2: 3 dBm/ tone output
 - (2) 54MHz to 1794MHz, 0dB tilt, 1 OFDM (54-246MHz) + 254 QAM (252-1794MHz) Channels. CCN Noise BW (ANSI/SCTE 17): 5.36MHz for J.83/B. Tx Data: ITU-T, Annex B, QAM256, 5.36 MSymbols/s

Performance Data vs Supply Voltage

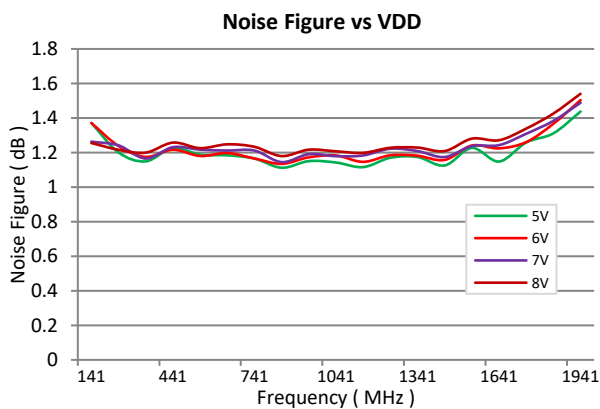
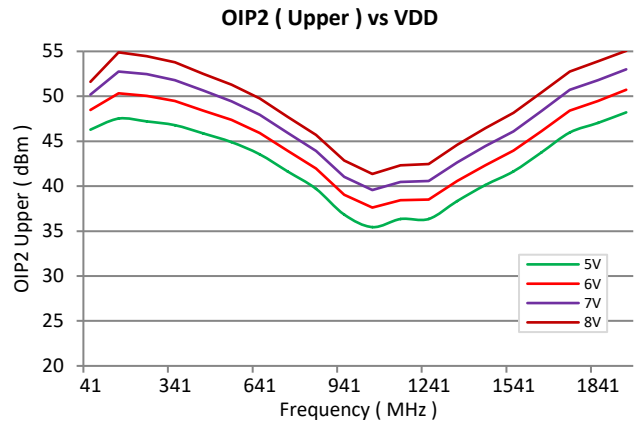
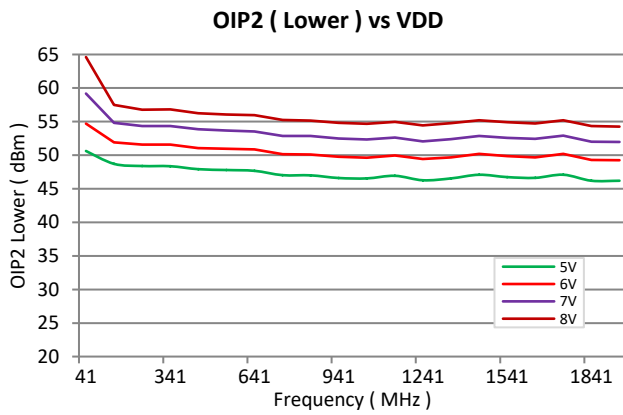
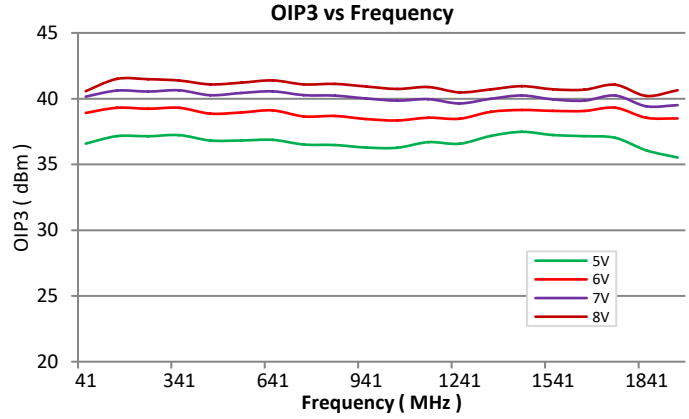
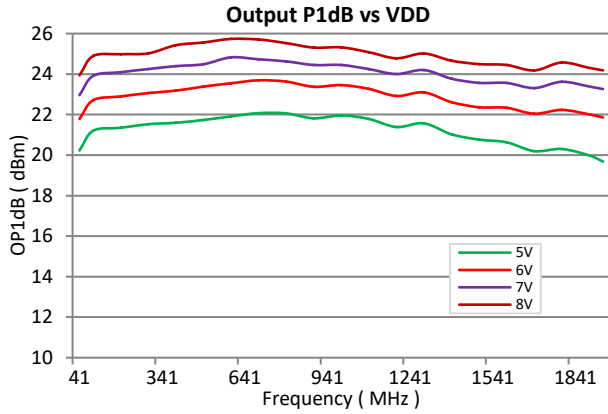

Notes:

- (1) OIP3: 7 dBm / tone output
- (2) OIP2: 3 dBm / tone output

Pin Configuration and Description

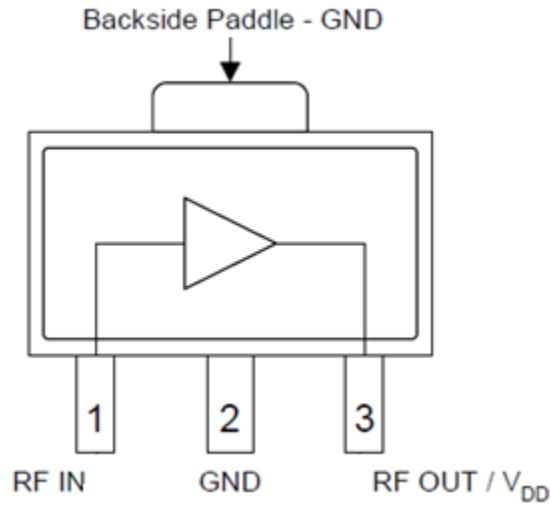

Top View

Pin Number	Label	Description
1	RF IN	RF Input, DC blocking capacitor required
2	GND	Internally Not Connected
3	RF OUT / VDD	RF Output – VDD bias choke required
Backside Paddle	GND	Ground. Use recommended via pattern to minimize inductance and thermal resistance. See PCB Mounting Pattern for suggested footprint.

Package Outline

Symbol	Dimensions In Millimeters	
	Min.	Max.
A	1.400	1.600
B	0.400	0.580
B1	0.320	0.520
C	0.350	0.440
D	4.400	4.600
D1	1.550 REF.	
D2	1.600 REF.	

Symbol	Dimensions In Millimeters	
	Min.	Max.
E	2.300	2.600
e	1.500 TYP.	
e1	3.000 TYP.	
H	3.940	4.250
L	0.900	1.200
M	1.900 REF.	
θ	45°	

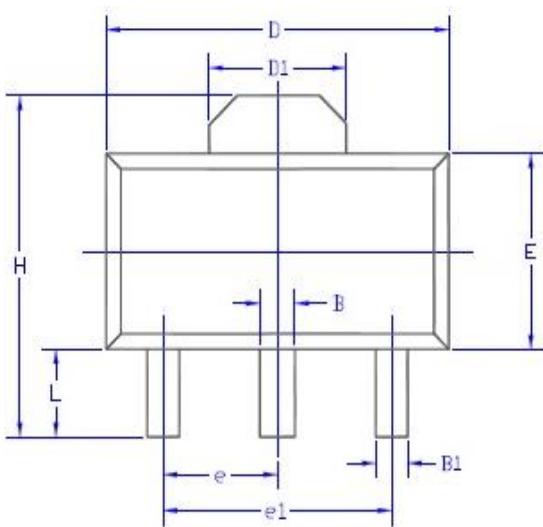

TOP
VIEW

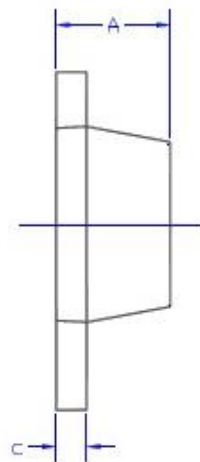

SIDE
VIEW

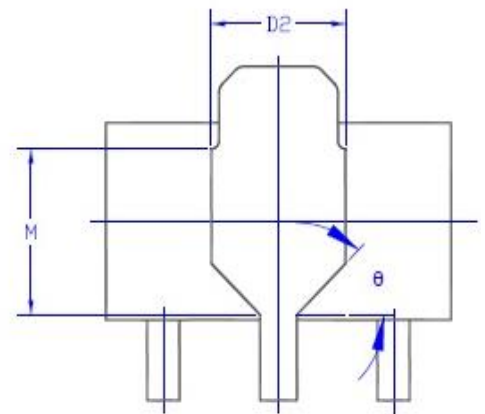

BOTTOM
VIEW

Package Marking

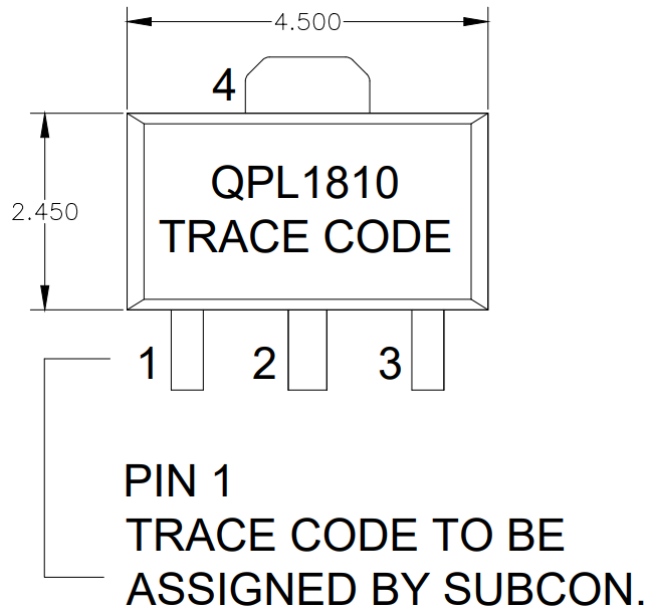

Recommended Mounting Pattern

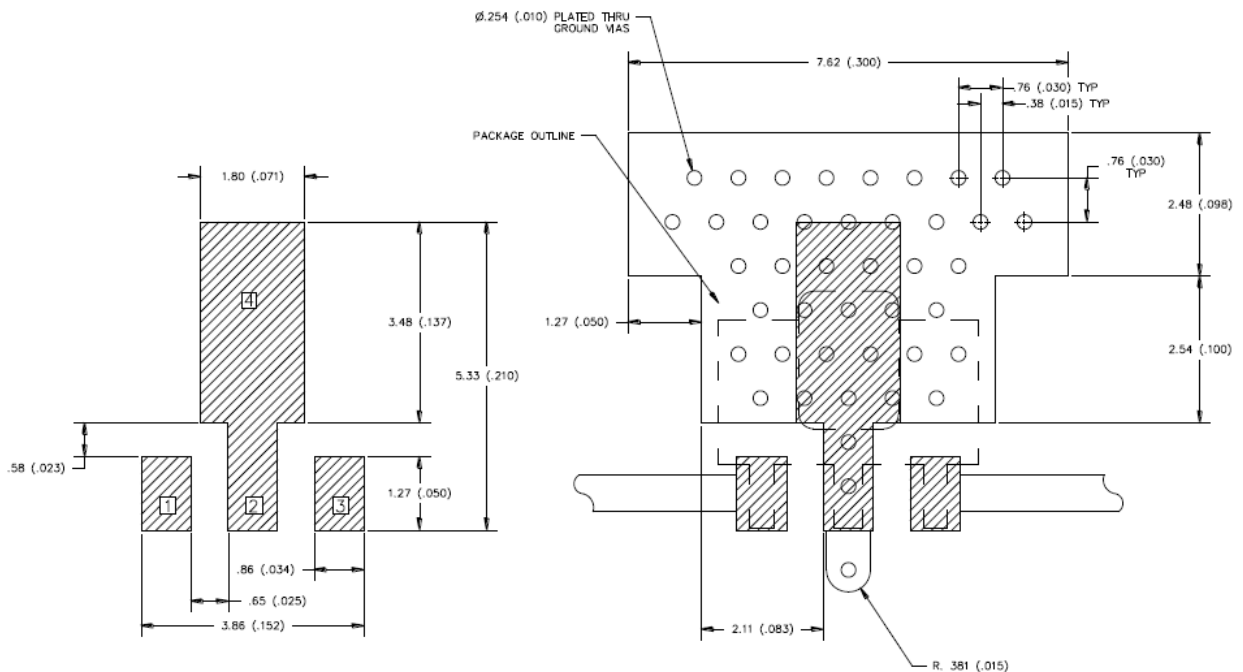

- Notes:
1. Ground/thermal vias are critical for the proper performance of this device. Vias should use a .35 mm (#80/.0135") diameter drill and have a final, plated thru diameter of 0.25 mm (0.010").
 2. Add as much copper as possible to inner and outer layers near the part to ensure optimal thermal performance.
 3. RF trace width depends upon the PC board material and construction.
 4. All dimensions are in millimeters (inches). Angles are in degrees.

Handling Precautions

Parameter	Rating	Standard
ESD – Human Body Model (HBM)	Class 1C (1000V to < 2000V)	ESDA/JEDEC JS-001
ESD – Charged Device Model (CDM)	Class C3 (≥1000V)	ESDA/JEDEC JS-002
MSL – Moisture Sensitivity Level	Level 3	IPC/JEDEC J-STD-020



Caution!
ESD-Sensitive
Device

Solderability

Compatible with lead-free (260 °C max. reflow temp.) soldering processes.

Solder profiles available upon request.

Contact plating: Matte Sn

RoHS Compliance

This part is compliant with 2011/65/EU RoHS directive (Restrictions on the Use of Certain Hazardous Substances in Electrical and Electronic Equipment) as amended by Directive 2015/863/EU.

This product also has the following attributes:

- Lead Free
- Halogen Free (Chlorine, Bromine)
- Antimony Free
- TBBP-A (C₁₅H₁₂Br₄O₂) Free
- PFOS Free
- SVHC Free



Contact Information

For the latest specifications, additional product information, worldwide sales and distribution locations:

Tel: 1-844-890-8163

Web: www.qorvo.com

Email: customer.support@qorvo.com

Important Notice

The information contained in this Data Sheet and any associated documents (“Data Sheet Information”) is believed to be reliable; however, Qorvo makes no warranties regarding the Data Sheet Information and assumes no responsibility or liability whatsoever for the use of said information. All Data Sheet Information is subject to change without notice. Customers should obtain and verify the latest relevant Data Sheet Information before placing orders for Qorvo® products. Data Sheet Information or the use thereof does not grant, explicitly, implicitly or otherwise any rights or licenses to any third party with respect to patents or any other intellectual property whether with regard to such Data Sheet Information itself or anything described by such information.

DATA SHEET INFORMATION DOES NOT CONSTITUTE A WARRANTY WITH RESPECT TO THE PRODUCTS DESCRIBED HEREIN, AND QORVO HEREBY DISCLAIMS ANY AND ALL WARRANTIES WITH RESPECT TO SUCH PRODUCTS WHETHER EXPRESS OR IMPLIED BY LAW, COURSE OF DEALING, COURSE OF PERFORMANCE, USAGE OF TRADE OR OTHERWISE, INCLUDING THE IMPLIED WARRANTIES OF MERCHANTABILITY AND FITNESS FOR A PARTICULAR PURPOSE. Without limiting the generality of the foregoing, Qorvo® products are not warranted or authorized for use as critical components in medical, life-saving, or life-sustaining applications, or other applications where a failure would reasonably be expected to cause severe personal injury or death. Applications described in the Data Sheet Information are for illustrative purposes only. Customers are responsible for validating that a particular product described in the Data Sheet Information is suitable for use in a particular application.

© 2024 Qorvo US, Inc. All rights reserved. This document is subject to copyright laws in various jurisdictions worldwide and may not be reproduced or distributed, in whole or in part, without the express written consent of Qorvo US, Inc. | QORVO® is a registered trademark of Qorvo US, Inc.

Looking for pricing, stock, or lifecycle information?

Click below to explore more details on WIN SOURCE:

 [View QPL1810SR on WIN SOURCE](#)

 [Qorvo US Inc. Information](#)

Optimize Your Supply Chain with WIN SOURCE Solutions

-  Global Sourcing Solution
-  Obsolete Management
-  Cost Control Management
-  Shortage Management
-  Alternative Solution
-  Excess Inventory Management