

### Product Overview

The CMD305 is a broadband MMIC driver amplifier ideally suited for EW and communications systems where small size and low power consumption are needed. At 11 GHz the device delivers greater than 18 dB of gain and +21 dBm saturated output power at 24 % PAE from a single 5 V supply. The CMD305 is a 50 ohm matched design eliminating the need for external DC blocks and RF port matching. The CMD305 offers full passivation for increased reliability and moisture protection.

### Key Features

- Broadband Performance
- High Output Power
- Low Current Consumption
- Single Positive Supply Voltage
- Small Die Size: 1350 um x 1100 um

### Functional Block Diagram

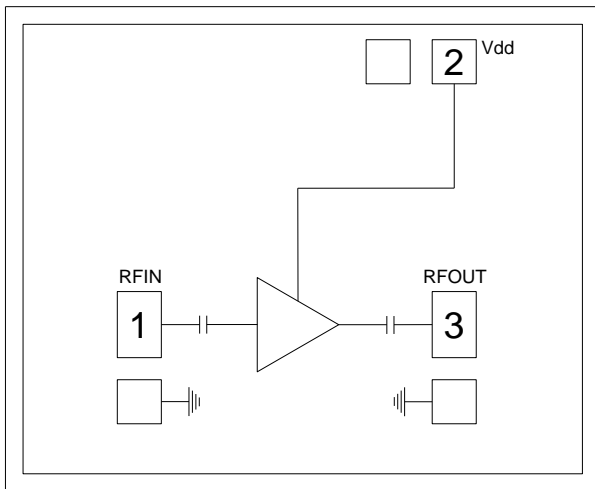

### Ordering Information

Part No.	Description
CMD305	6-16 GHz Driver Amplifier, 100 Piece Gel Pack

### Electrical Performance ( $V_{dd} = 5.0\text{ V}$ , $T_A = 25\text{ }^\circ\text{C}$ , $F = 11\text{ GHz}$ )

Parameter	Min	Typ	Max	Units
Frequency Range		6 - 16		GHz
Gain		18.5		dB
Input Return Loss		20		dB
Output Return Loss		9		dB
Output P1dB		20		dBm
Output Psat		21		dBm
Output IP3		34		dBm
Supply Current		100		mA

## Absolute Maximum Ratings

Parameter	Rating
Drain Voltage, $V_{dd}$	5.5 V
RF Input Power	+10 dBm
Channel Temperature, $T_{ch}$	150 °C
Power Dissipation, $P_{diss}$	650 mW
Thermal Resistance, $\theta_{JC}$	100 °C/W
Operating Temperature	-55 to 85 °C
Storage Temperature	-55 to 150 °C

Exceeding any one or combination of the maximum ratings may cause permanent damage to the device.

## Recommended Operating Conditions

Parameter	Min	Typ	Max	Units
$V_{dd}$	3.0	5.0	5.25	V
$I_{dd}$		100		mA

Electrical performance is measured at specific test conditions. Electrical specifications are not guaranteed over all recommended operating conditions.

## Drain Current vs. Drain Voltage

$V_{dd}$ (V)	$I_{dd}$ (mA)
3.0	65
4.0	85
5.0	100

## Electrical Specifications ( $V_{dd} = 5.0$ V, $T_A = 25$ °C)

Parameter	Min	Typ	Max	Min	Typ	Max	Units
Frequency Range		6 - 9			9 - 16		GHz
Gain	16	19.5		15	18		dB
Noise Figure		6			4		dB
Input Return Loss		11			13		dB
Output Return Loss		9			9		dB
Output P1dB	16.5	20		17	20.5		dBm
Output Psat		21			21.5		dBm
Output IP3		33			34		dBm
Supply Current	70	100	130	70	100	130	mA
Gain Temperature Coefficient		0.010			0.010		dB/°C

Typical Performance

Broadband Performance,  $V_{dd} = 5.0\text{ V}$ ,  $T_A = 25\text{ }^\circ\text{C}$

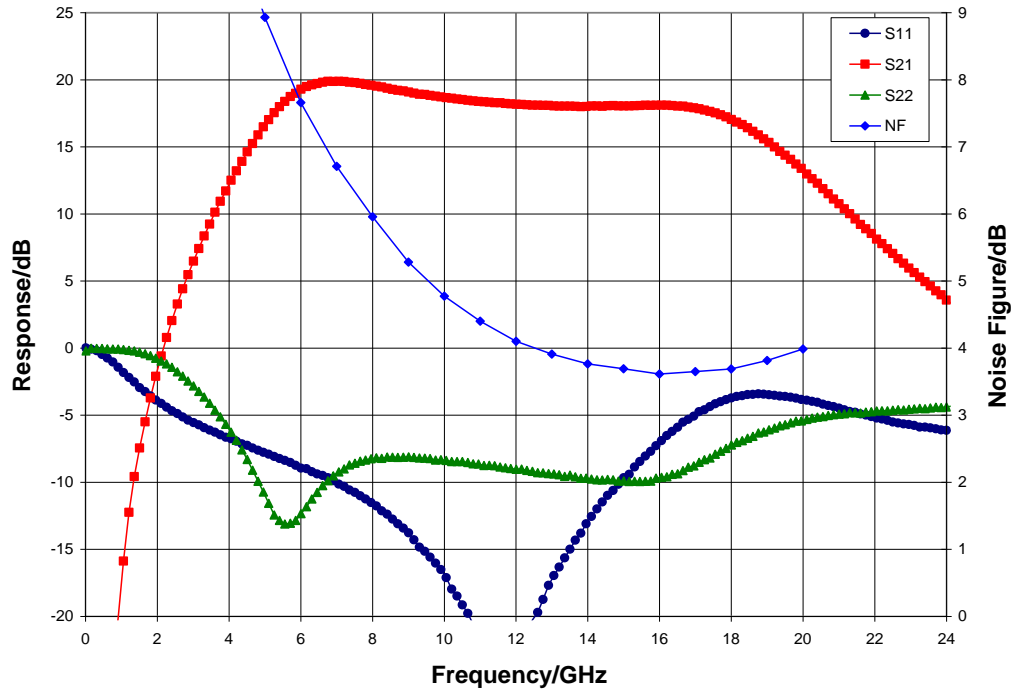

Narrow-band Performance,  $V_{dd} = 5.0\text{ V}$ ,  $T_A = 25\text{ }^\circ\text{C}$

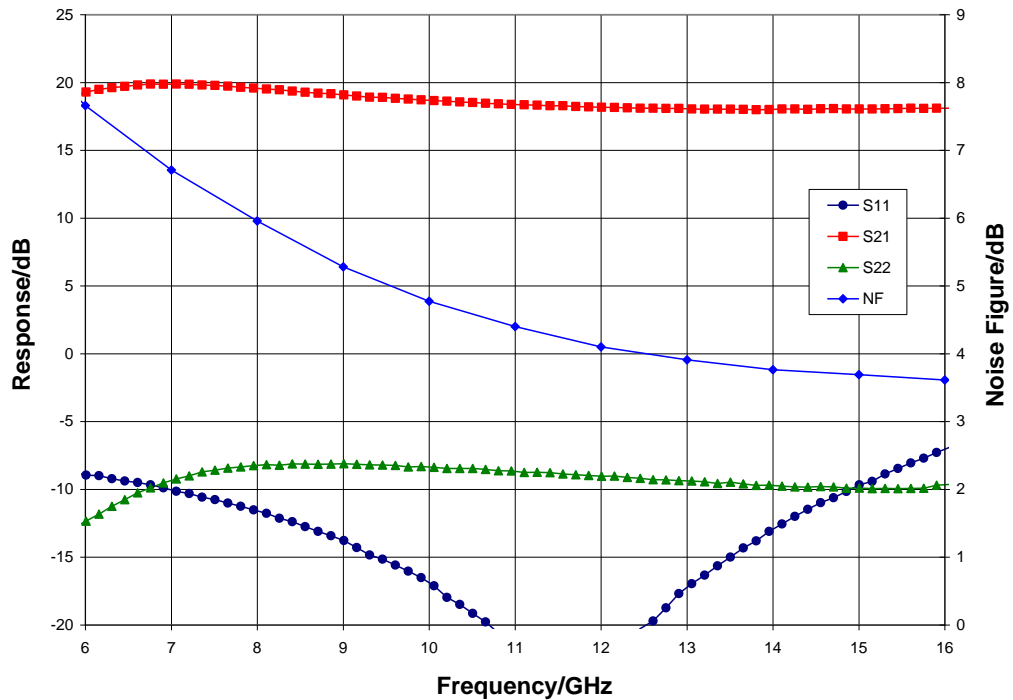

Typical Performance

Gain vs. Temperature,  $V_{dd} = 5.0\text{ V}$

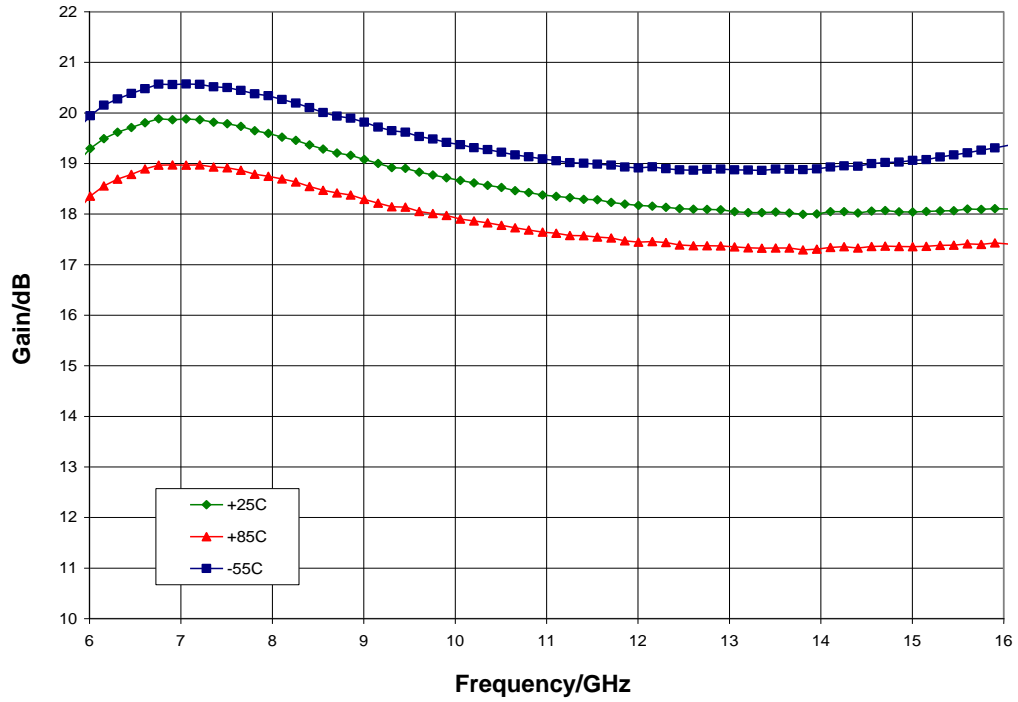

Gain vs.  $V_{dd}$ ,  $T_A = 25\text{ °C}$

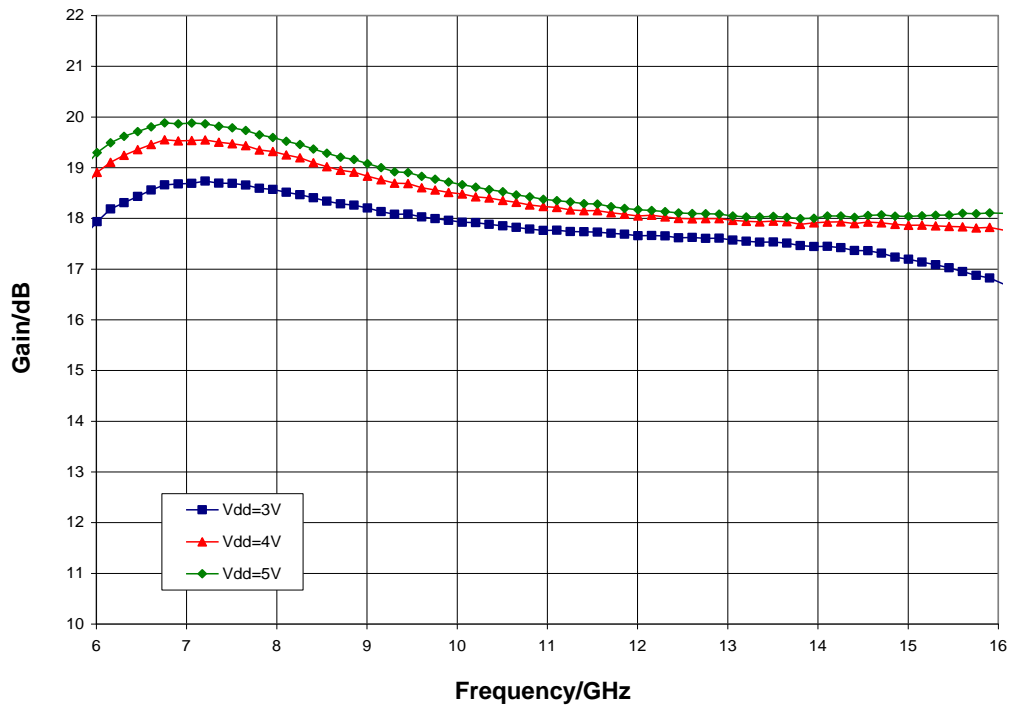

Typical Performance

Noise Figure vs. Temperature,  $V_{dd} = 5.0\text{ V}$

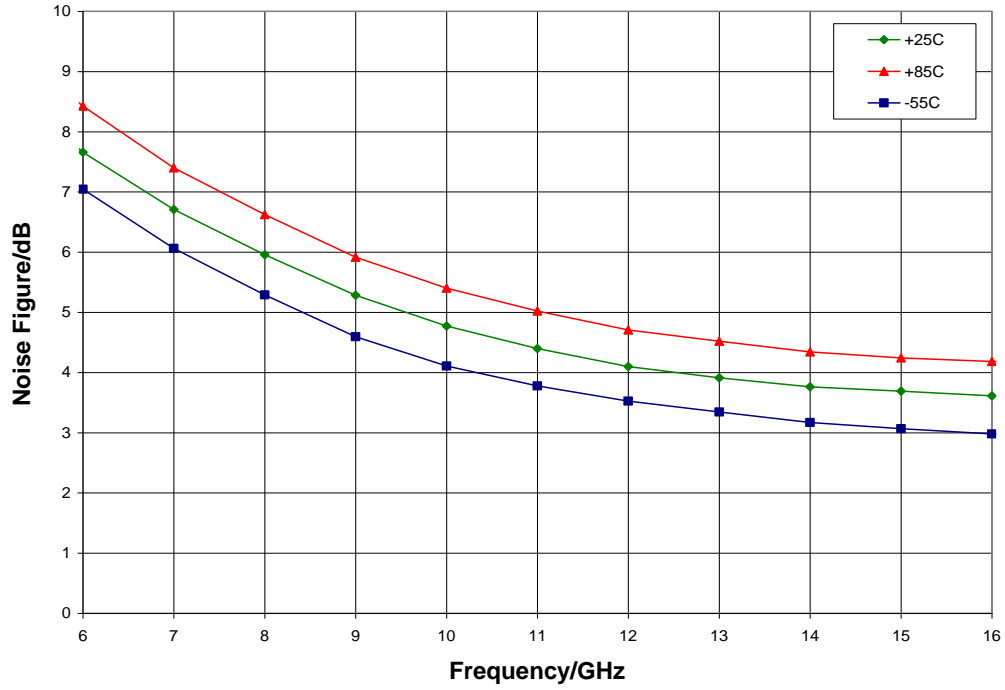

Noise Figure vs.  $V_{dd}$ ,  $T_A = 25\text{ °C}$

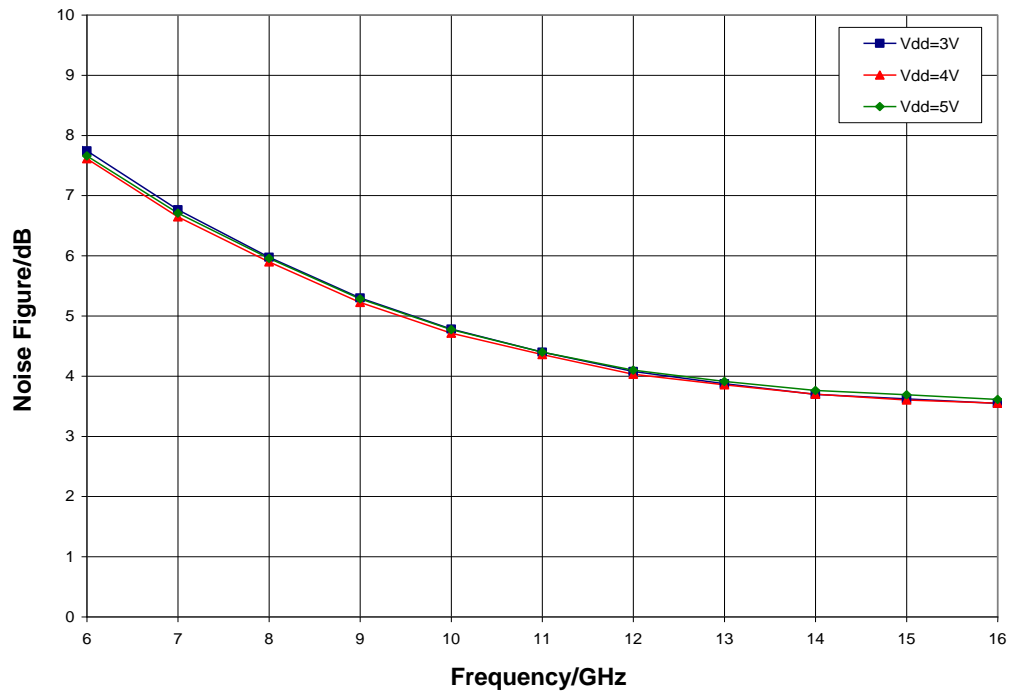

Typical Performance

P1dB vs. Temperature,  $V_{dd} = 5.0\text{ V}$

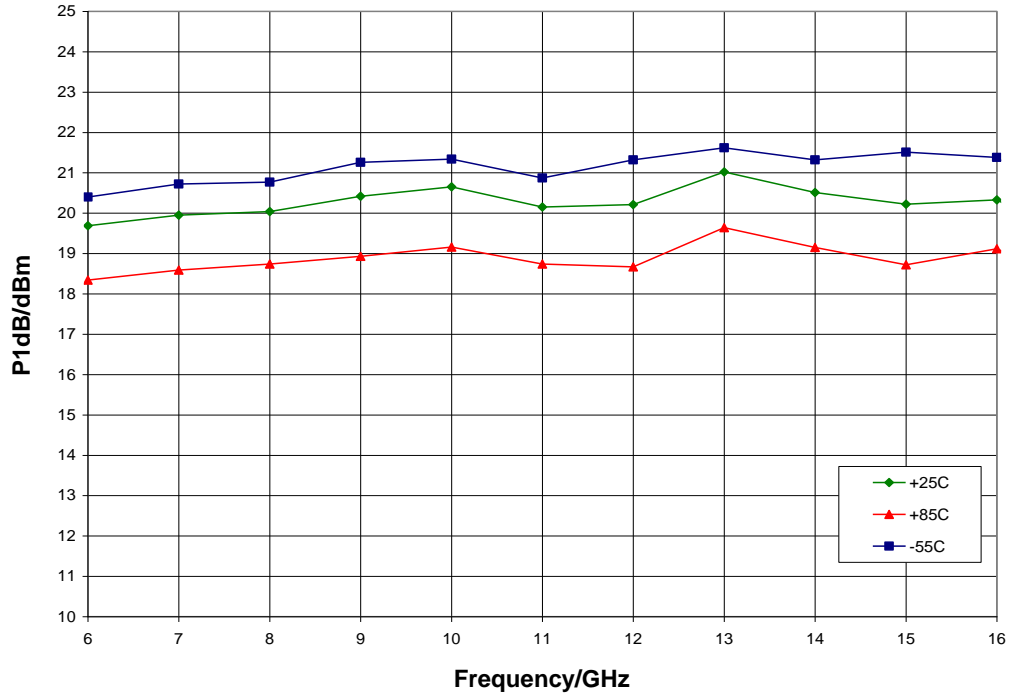

P1dB vs.  $V_{dd}$ ,  $T_A = 25\text{ °C}$

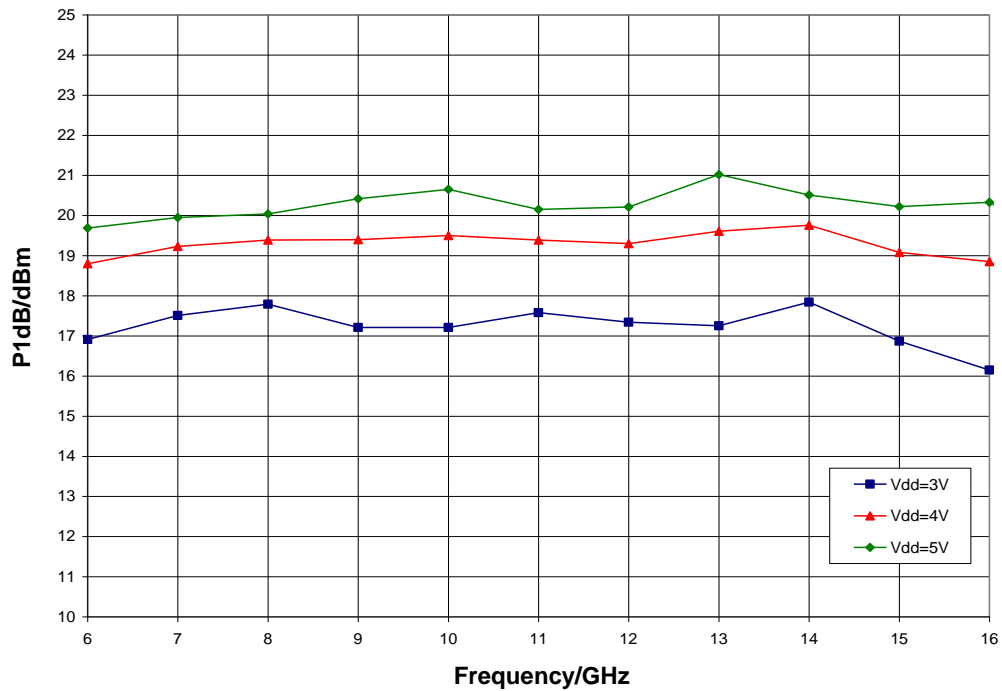

Typical Performance

Psat vs. Temperature,  $V_{dd} = 5.0\text{ V}$

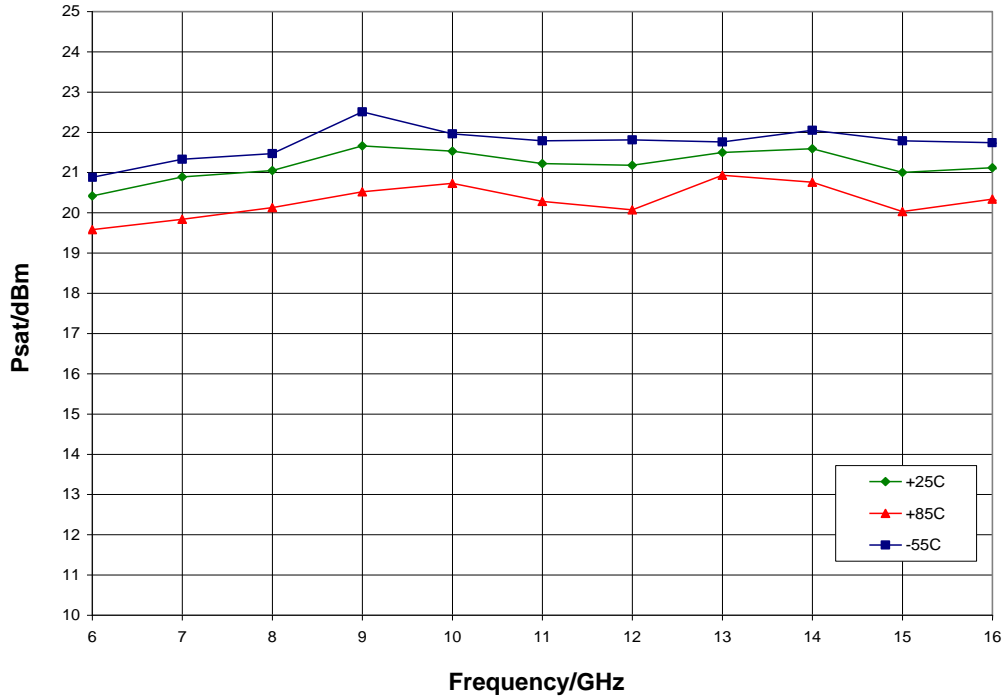

Psat vs.  $V_{dd}$ ,  $T_A = 25\text{ °C}$

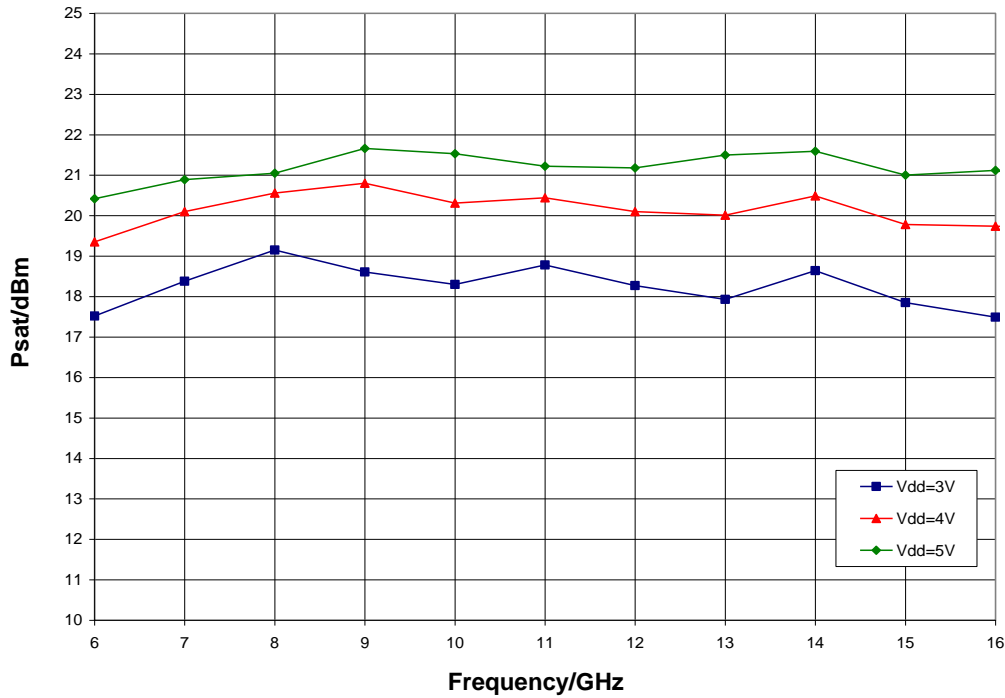

Typical Performance

Output IP3 vs. Temperature,  $V_{dd} = 5.0\text{ V}$

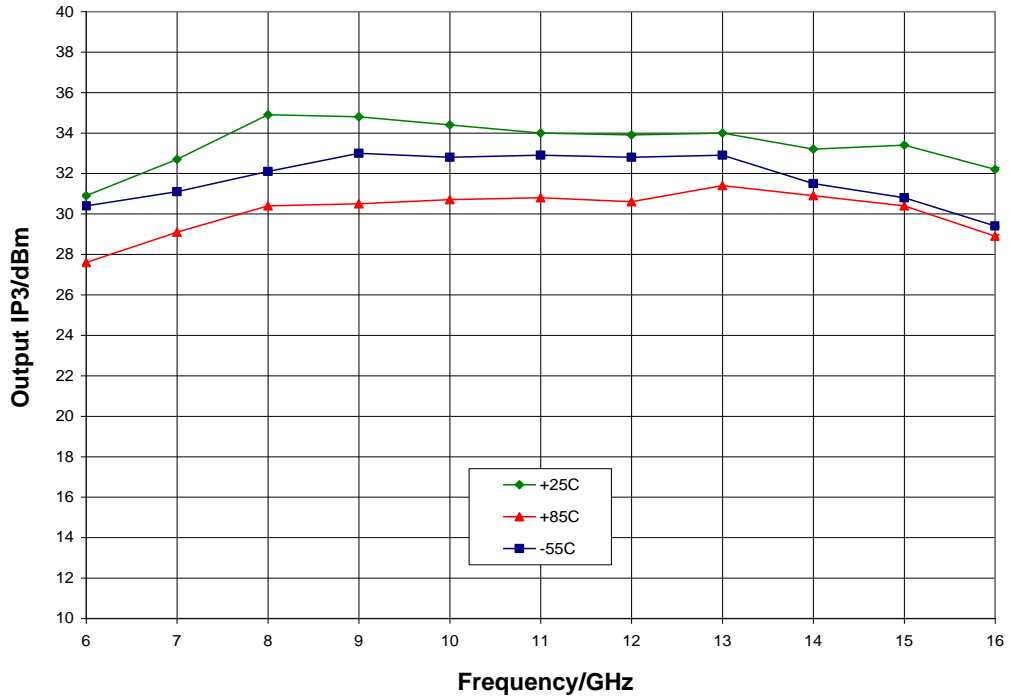

Output IP3 vs.  $V_{dd}$ ,  $T_A = 25\text{ °C}$

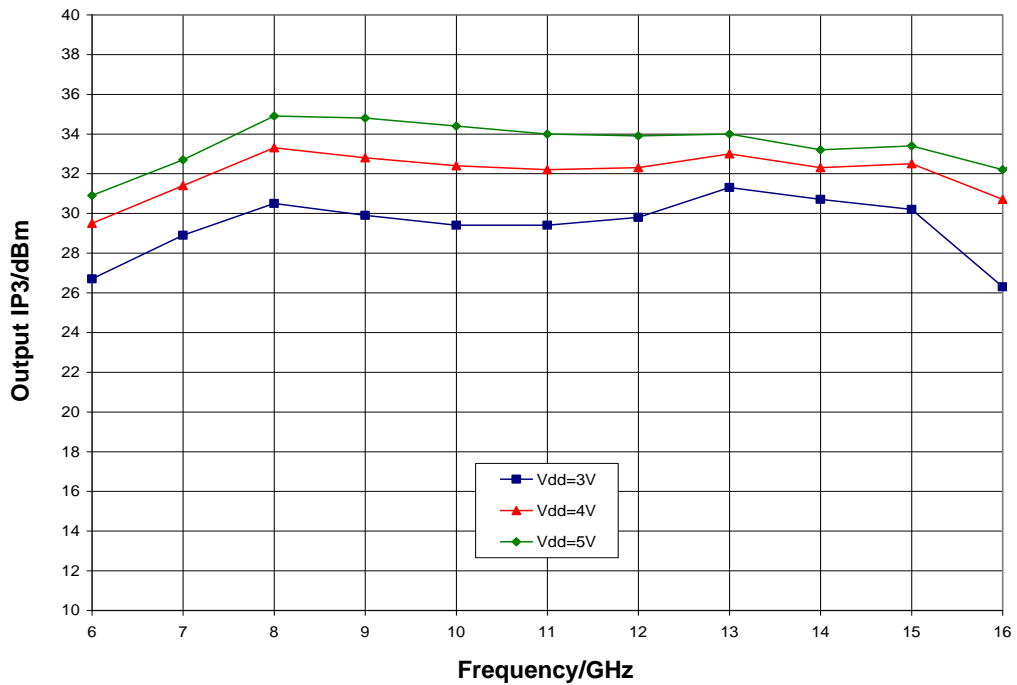

Mechanical Information

Die Outline (all dimensions in microns)

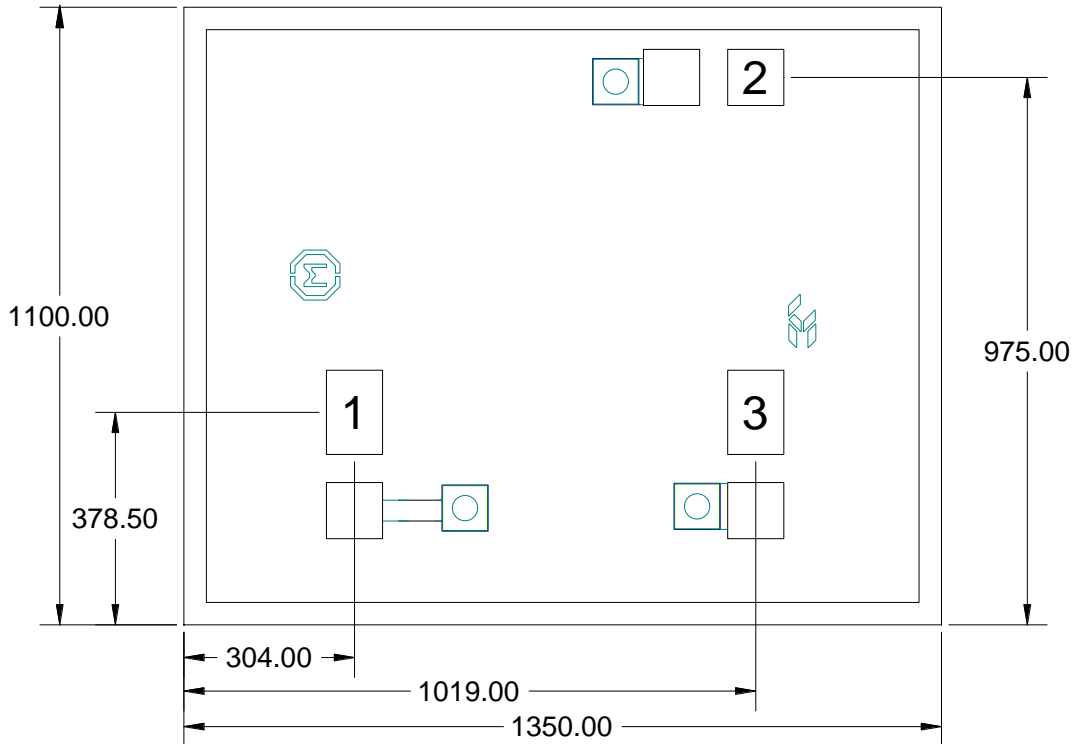

Notes:

1. No connection required for unlabeled pads
2. Backside is RF and DC ground
3. Backside and bond pad metal: Gold
4. Die is 100 microns thick
5. DC bond pad (2) is 100 x 100 microns
6. RF bond pads (1, 3) are 100 x 150 microns

## Pad Description

### Pad Diagram

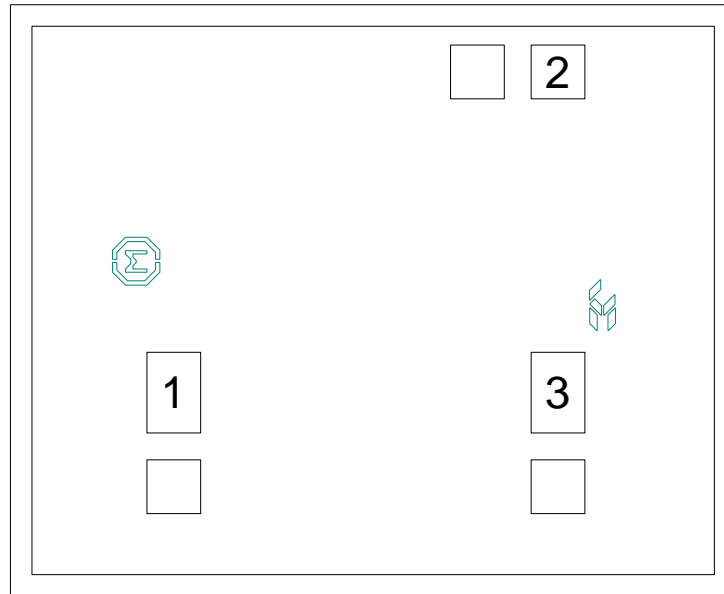

### Functional Description

Pad	Function	Description	Schematic
1	RF in	DC blocked and 50 ohm matched	
2	V <sub>dd</sub>	Power supply voltage Decoupling and bypass caps required	
3	RF out	DC blocked and 50 ohm matched	
Backside	Ground	Connect to RF / DC ground	

**Applications Information**

**Assembly Guidelines**

The backside of the CMD305 is RF ground. Die attach should be accomplished with electrically and thermally conductive epoxy only. Eutectic attach is not recommended. Standard assembly procedures should be followed for high frequency devices. The top surface of the semiconductor should be made planar to the adjacent RF transmission lines, and the RF decoupling capacitors placed in close proximity to the DC connections on chip.

RF connections should be made as short as possible to reduce the inductive effect of the bond wire. Use of a 0.8 mil thermosonic wedge bonding is highly recommended as the loop height will be minimized. The RF input and output require a double bond wire as shown.

The semiconductor is 100 um thick and should be handled by the sides of the die or with a custom collet. Do not make contact directly with the die surface as this will damage the monolithic circuitry. Handle with care.

**Assembly Diagram**

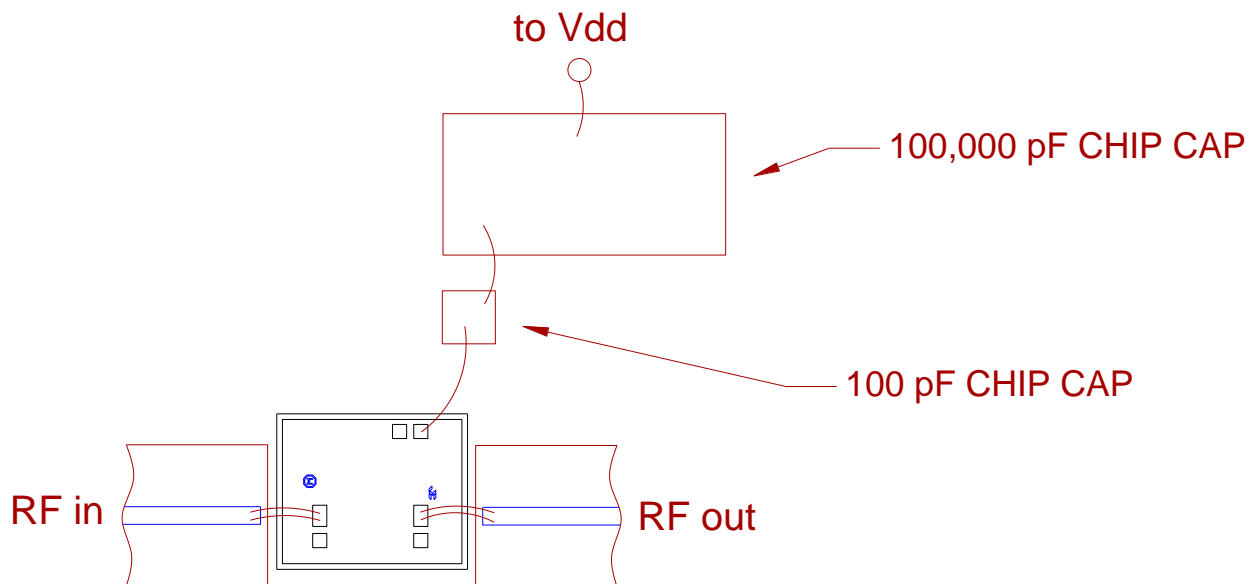

**GaAs MMIC devices are susceptible to damage from Electrostatic Discharge. Proper precautions should be observed during handling, assembly and test.**

## Applications Information

---

### Biasing and Operation

The CMD305 is biased with a positive drain supply. Performance is optimized when the drain voltage is set to +5.0 V, though it may be set to a minimum of +3.0 V.

Turn ON procedure:

1. Apply drain voltage  $V_{dd}$  and set to +5 V

Turn OFF procedure:

1. Turn off drain voltage  $V_{dd}$

RF power can be applied at any time.

**Handling Precautions**

Parameter	Rating	Standard
ESD – Human Body Model (HBM)	Class 1A	ESDA / JEDEC JS-001-2012



Caution!  
 ESD-Sensitive Device

**RoHS Compliance**

This part is compliant with 2011/65/EU RoHS directive (Restrictions on the Use of Certain Hazardous Substances in Electrical and Electronic Equipment) as amended by Directive 2015/863/EU.

This product also has the following attributes:

- Lead Free
- Antimony Free
- TBBP-A (C<sub>15</sub>H<sub>12</sub>Br<sub>4</sub>O<sub>2</sub>) Free
- SVHC Free
- Halogen Free
- PFOS Free

**Contact Information**

For the latest specifications, additional product information, worldwide sales and distribution locations:

Web: [www.qorvo.com](http://www.qorvo.com)

Tel: 1-844-890-8163

Email: [customer.support@qorvo.com](mailto:customer.support@qorvo.com)

**Important Notice**

The information contained in this Data Sheet and any associated documents (“Data Sheet Information”) is believed to be reliable; however, Qorvo makes no warranties regarding the Data Sheet Information and assumes no responsibility or liability whatsoever for the use of said information. All Data Sheet Information is subject to change without notice. Customers should obtain and verify the latest relevant Data Sheet Information before placing orders for Qorvo® products. Data Sheet Information or the use thereof does not grant, explicitly, implicitly or otherwise any rights or licenses to any third party with respect to patents or any other intellectual property whether with regard to such Data Sheet Information itself or anything described by such information.

DATA SHEET INFORMATION DOES NOT CONSTITUTE A WARRANTY WITH RESPECT TO THE PRODUCTS DESCRIBED HEREIN, AND QORVO HEREBY DISCLAIMS ANY AND ALL WARRANTIES WITH RESPECT TO SUCH PRODUCTS WHETHER EXPRESS OR IMPLIED BY LAW, COURSE OF DEALING, COURSE OF PERFORMANCE, USAGE OF TRADE OR OTHERWISE, INCLUDING THE IMPLIED WARRANTIES OF MERCHANTABILITY AND FITNESS FOR A PARTICULAR PURPOSE. Without limiting the generality of the foregoing, Qorvo® products are not warranted or authorized for use as critical components in medical, life-saving, or life-sustaining applications, or other applications where a failure would reasonably be expected to cause severe personal injury or death. Applications described in the Data Sheet Information are for illustrative purposes only. Customers are responsible for validating that a particular product described in the Data Sheet Information is suitable for use in a particular application.

© 2023 Qorvo US, Inc. All rights reserved. This document is subject to copyright laws in various jurisdictions worldwide and may not be reproduced or distributed, in whole or in part, without the express written consent of Qorvo US, Inc. | QORVO® is a registered trademark of Qorvo US, Inc.

## Looking for pricing, stock, or lifecycle information?

Click below to explore more details on WIN SOURCE:

 [View CMD305 on WIN SOURCE](#)

 [Qorvo US Inc. Information](#)

## Optimize Your Supply Chain with WIN SOURCE Solutions

-  Global Sourcing Solution
-  Obsolete Management
-  Cost Control Management
-  Shortage Management
-  Alternative Solution
-  Excess Inventory Management