

1.75 dB NF Low Noise Amplifier Operating From 1 GHz to 12 GHz with 16 dB Gain, 17 dBm P1dB and SMA

FMAM1031 is a low noise amplifier that operates across the frequency range from 1 GHz to 12 GHz. The design utilizes GaAs HBT MMIC technology. The design also exhibits high dynamic range with typical performance at 8 GHz that includes 16 dB of small signal gain, 1.75 dB noise figure, up to +17 dBm typ of output power at P1dB, +31 dBm output IP3, while using +6V DC supply and -5V DC supply. The wideband distributed amplifier design input/output ports are internally matched to 50 ohms and are DC blocked.

The drop-in package is hermetically sealed with field replaceable SMA connectors and has an operating temperature range of -55°C to +85°C. And for added confidence, this rugged package assembly is designed to meet MIL-STD-883 test conditions for Hermeticity and Temperature Cycle.

This Broadband Low Noise Amplifier Module is part of Fairview Microwave's expanding line of Amplifier offerings. These modules offer very wide Frequency Range coverage and outstanding electrical performance in the band.



Features:

- Low Noise Amplifier
- Wide Frequency Band
- Highly Linear GaAs HBT MMIC Technology
- Gain 16 dB
- Noise Figure 1.75 typ
- High Output IP3 +31 dBm
- P1dB up to +17 dBm
- Hermetically Sealed Module
- Mil Spec Compliant
- Field Replaceable SMA Connectors
- -55°C to +85°C Operating Temperature

Functional Block Diagram

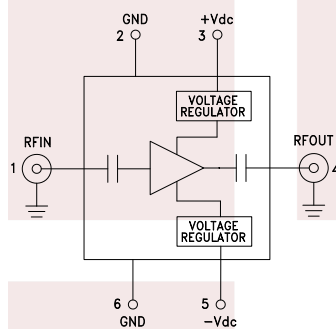

Applications:

- Electronic Warfare
- Microwave Radio
- VSAT
- Radar
- Space Systems
- Test Instrumentation
- Telecom Infrastructure

Electrical Specifications (TA = +25°C , DC Voltage = 6Vdc , DC Current = 60mA)

Description	Min	Typ	Max	Unit
Frequency Range	1		12	GHz
Small Signal Gain		16		dB
Output at 1 dB Compression Point		+17		dBm
Noise Figure		1.75		dB
Operating DC Voltage		6		Volts
Operating DC Current		60		mA
Operating Temperature Range	-55		+85	°C

Fairview Microwave
 1130 Junction Dr. #100
 Allen, TX 75013
 Tel: 1-800-715-4396 / (972) 649-6678
 Fax: (972) 649-6689
www.fairviewmicrowave.com
sales@fairviewmicrowave.com

Performance by Frequency

Description	Min.	Typ.	Max.	Min.	Typ.	Max.	Units
Frequency Range		1 - 8			8 - 12		GHz
Gain	14	16		12	14		dB
Gain Flatness		±1			±1.25		dB
Gain Variation Over Temperature		0.005			0.005		dB/ °C
Noise Figure		1.75	2.25		2.5	3	dB
Input Return Loss		-12			-7		dB
Output Return Loss		-17			-15		dB
Output Power For 1 dB Compression (P1dB)		17			14		dBm
Saturated Output Power (Psat)		19			17		dBm
Output Third Order Intercept (IP3)		31			29		dBm
Positive Supply Current (+Idc)		60	70		60	70	mA
Negative Supply Current (-Idc)		1.5			1.5		mA

Mechanical Specifications

Size

Length 1.14 in [28.96 mm]
 Width 1.9 in [48.26 mm]
 Height 0.56 in [14.22 mm]
 Weight 0.09 lbs [40.82 g]

Connector Option Field Replaceable
 Input Connector SMA Female
 Output Connector SMA Female

Environmental Specifications

Temperature

Operating Range -55 to +85 deg C
 Storage Range -65 to +150 deg C

Temperature Cycling MIL-STD-883, Method 101C, Cond B
 Hermetic Seal Gross Leak MIL-STD-883 Method 1014C1/Fine Leak MIL-STD-883, Method 1014A2, 5 x 10⁻⁸ atm cc

ESD Sensitivity ESD Sensitive Material, Transport material in Approved ESD bags. Handle only in ESD Workstation.



Compliance Certifications (see [product page](#) for current document)

Plotted and Other Data

Notes:
 • Values at 25 °C, sea level

Typical Performance Data

Broadband Gain & Return Loss

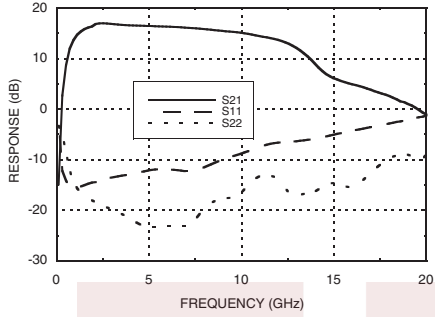

Gain vs. Temperature

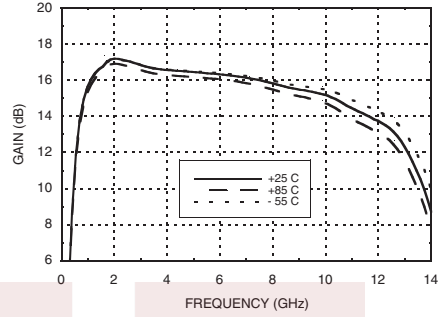

Input Return Loss vs. Temperature

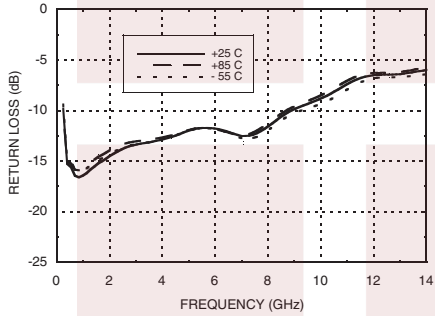

Output Return Loss vs. Temperature

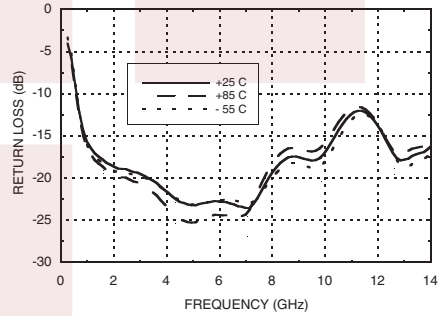

Reverse Isolation vs. Temperature

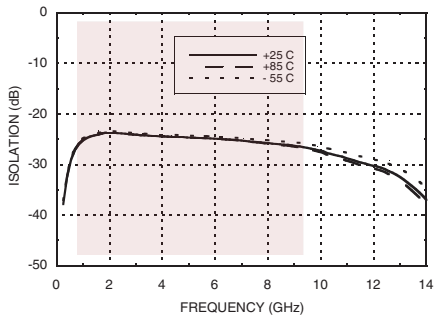

Noise Figure vs. Temperature

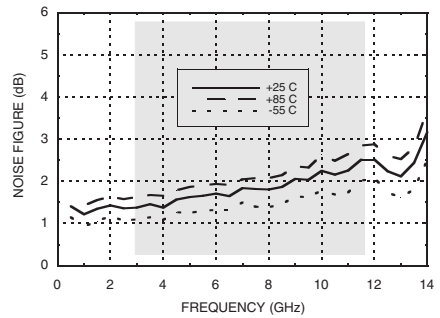

P1dB vs. Temperature

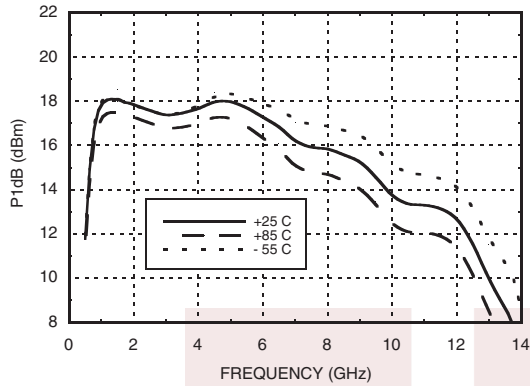

Psat vs. Temperature

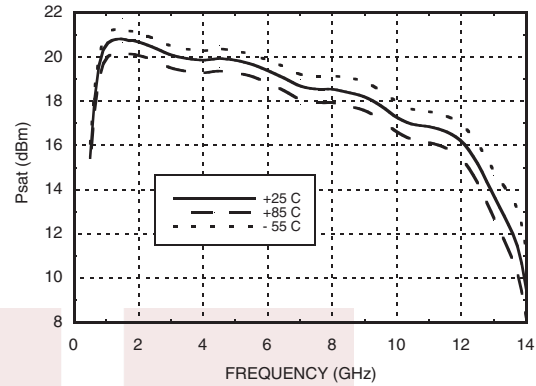

Output IP3 vs. Temperature

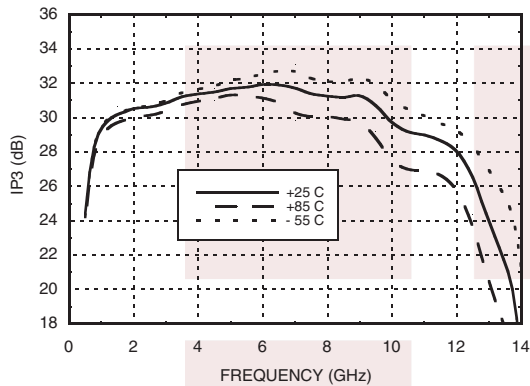

1.75 dB NF Low Noise Amplifier Operating From 1 GHz to 12 GHz with 16 dB Gain, 17 dBm P1dB and SMA from Fairview Microwave is in-stock and available to ship same-day. All of our RF/microwave products are available off-the-shelf from our ISO 9001:2008 certified facilities in Allen, Texas. Fairview Microwave is RF on-demand.

For additional information on this product, please click the following link: [1.75 dB NF Low Noise Amplifier Operating From 1 GHz to 12 GHz with 16 dB Gain, 17 dBm P1dB and SMA FMAM1031](https://www.fairviewmicrowave.com/1.75db-nf-low-noise-amplifier-16db-fmam1031-p.aspx)

URL: <https://www.fairviewmicrowave.com/1.75db-nf-low-noise-amplifier-16db-fmam1031-p.aspx>

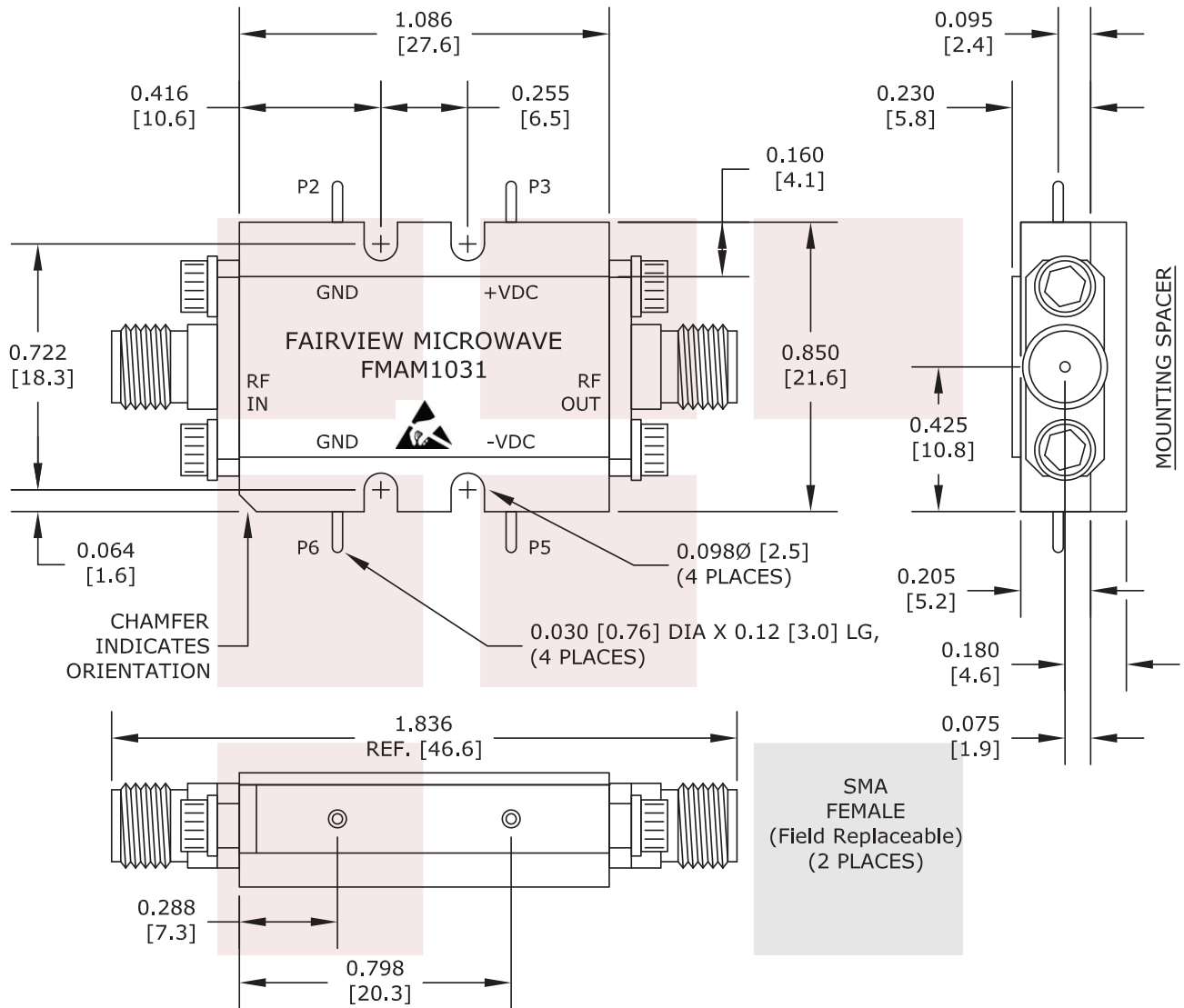

The information contained in this document is accurate to the best of our knowledge and representative of the part described herein. It may be necessary to make modifications to the part and/or the documentation of the part, in order to implement improvements. Fairview Microwave reserves the right to make such changes as required. Unless otherwise stated, all specifications are nominal. Fairview Microwave does not make any representation or warranty regarding the suitability of the part described herein for any particular purpose, and Fairview Microwave does not assume any liability arising out of the use of any part or documentation.



FAIRVIEW MICROWAVE INC. ALLEN, TX 75013 WWW.FAIRVIEWMICROWAVE.COM		NOTES: 1. UNLESS OTHERWISE SPECIFIED ALL DIMENSIONS ARE NOMINAL. 2. ALL SPECIFICATIONS ARE SUBJECT TO CHANGE WITHOUT NOTICE AT ANY TIME. 3. DIMENSIONS ARE IN INCHES [mm].			
TITLE 1.75 dB NF Low Noise Amplifier Operating From 1 GHz to 12 GHz with 16 dB Gain, 17 dBm P1dB and SMA		DWG NO FMAM1031		CAGE CODE 3FKR5	
CAD FILE	093016	SHEET	SCALE	N/A	SIZE A 2233

Looking for pricing, stock, or lifecycle information?

Click below to explore more details on WIN SOURCE:

-  [View FMAM1031 on WIN SOURCE](#)
-  [Fairview Microwave Information](#)

Optimize Your Supply Chain with WIN SOURCE Solutions

-  Global Sourcing Solution
-  Obsolete Management
-  Cost Control Management
-  Shortage Management
-  Alternative Solution
-  Excess Inventory Management