

Description

The F0452C is an integrated dual-path RF front-end consisting of an RF switch and two gain stages with 6dB gain control used in the analog front-end receiver of an Active Antenna System (AAS). The F0452C supports frequencies from 2.3GHz to 2.7GHz.

The F0452C provides 34dB gain with +23dBm OIP3, +15dBm output P1dB, and 1.6dB noise figure (NF) at 2.6GHz. Gain is reduced 6dB in a single step with a maximum gain settling time of 31ns. The device uses a single 3.3V supply and 130mA of I_{DD} .

The F0452C is offered in a $6 \times 6 \times 0.75$ mm, 32-pin LGA package with 50Ω input and output amplifier impedances for ease of integration into the signal path.

Competitive Advantage

- High integration
- Low noise and high linearity
- On-chip matching and bias
- Extremely low current consumption

Typical Applications

- Multi-mode, multi-carrier receivers
- AAS Rx Front-End
- 4.5G (LTE Advanced)
- 5G NR band n40 and n41

Features

- Gain at 2.6GHz
 - 34dB typical in High Gain Mode
 - 28dB typical in Low Gain Mode
- 1.6dB NF at 2.6GHz
- +23dBm OIP3 at 2.6GHz
- OP1dB at 2.6GHz
 - +15dBm in High Gain Mode
 - +14dBm in Low Gain Mode
- 50Ω single-ended input / output amplifier impedances
- $I_{DD} = 130\text{mA}$
- Independent Standby Mode for power savings
- Supply voltage: +3.15V to +3.45V
- 6×6 mm, 32-LGA package
- -40°C to $+105^\circ\text{C}$ exposed pad operating temperature range

Block Diagram

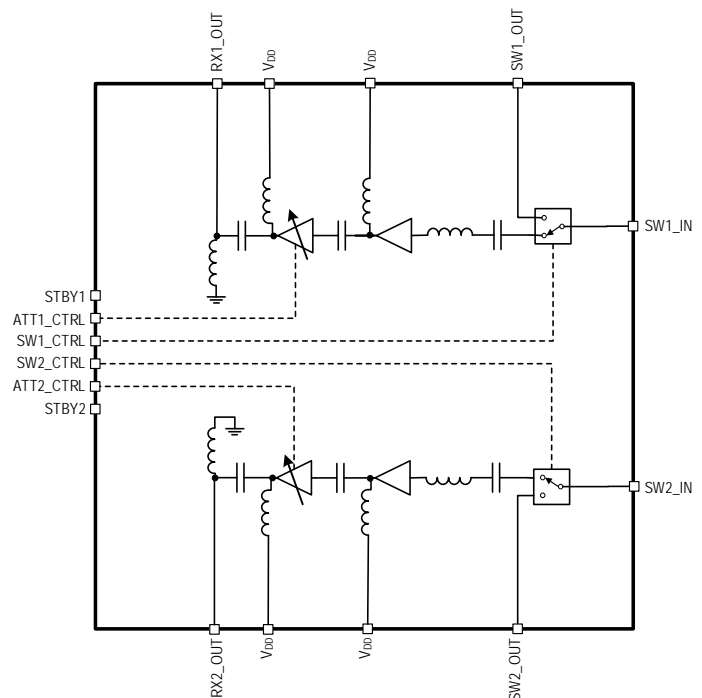

Contents

| | |
|--|----|
| Pin Assignments..... | 4 |
| Pin Descriptions..... | 5 |
| Absolute Maximum Ratings..... | 6 |
| Recommended Operating Conditions | 7 |
| Electrical Characteristics | 8 |
| Thermal Characteristics..... | 12 |
| Typical Operating Conditions | 12 |
| Programming..... | 12 |
| Typical Performance Characteristics..... | 13 |
| Evaluation Kit Picture | 17 |
| Evaluation Kit Circuit | 18 |
| Application Information..... | 20 |
| Power Supplies..... | 20 |
| Control Pin Interface..... | 20 |
| Marking Diagram | 21 |
| Package Outline Drawings | 21 |
| Ordering Information..... | 21 |
| Revision History..... | 21 |

List of Figures

| | |
|---|----|
| Figure 1. Pin Assignments for 6 × 6 × 0.75 mm 32-LGA – Top View | 4 |
| Figure 2. Rx Mode Gain (High Gain) | 13 |
| Figure 3. Rx Mode Gain (Low Gain) | 13 |
| Figure 4. Rx Mode Reverse Isolation (High Gain) | 13 |
| Figure 5. Rx Mode Reverse Isolation (Low Gain) | 13 |
| Figure 6. Rx Mode Input Return Loss (High Gain)..... | 13 |
| Figure 7. Rx Mode Input Return Loss (Low Gain) | 13 |
| Figure 8. Rx Mode Output Return Loss (High Gain)..... | 14 |
| Figure 9. Rx Mode Output Return Loss (Low Gain)..... | 14 |
| Figure 10. Rx Mode OP1dB (High Gain) | 14 |
| Figure 11. Rx Mode OP1dB (Low Gain) | 14 |
| Figure 12. Rx Mode OIP3 (High Gain)..... | 14 |
| Figure 13. Rx Mode OIP3 (Low Gain) | 14 |
| Figure 14. Rx Mode Noise Figure (High Gain) | 15 |
| Figure 15. Rx Mode Noise Figure (Low Gain) | 15 |
| Figure 16. Tx Mode RF Switch Isolation..... | 15 |
| Figure 17. Rx Mode Channel Isolation | 15 |

Figure 18. Stability Factor15

Figure 19. Gain Settling Time16

Figure 20. Gain Step Phase Settling Time16

Figure 21. Power OFF Switching Time16

Figure 22. Power ON Switching Time16

Figure 23. Power OFF to Standby Mode16

Figure 24. Power ON from Standby Mode16

Figure 25. Power ON from Standby Mode16

Figure 26. Evaluation Kit: Top View17

Figure 27. Evaluation Kit: Bottom View17

Figure 28. Electrical Schematic18

Figure 29. Control Pin Interface Schematic20

List of Tables

Table 1. Pin Descriptions5

Table 2. Absolute Maximum Ratings6

Table 3. Recommended Operating Conditions7

Table 4. Electrical Characteristics8

Table 5. Electrical Characteristics – RX Path in RX Mode Cascaded Performance10

Table 6. Electrical Characteristics – RX Path in RX Mode Cascaded Performance and TX Performance11

Table 7. Thermal Characteristics12

Table 8. Gain Step Truth Table12

Table 9. Standby and RF Switch Truth Table12

Table 10. Bill of Material (BOM)19

Pin Assignments

Figure 1. Pin Assignments for 6 × 6 × 0.75 mm 32-LGA – Top View

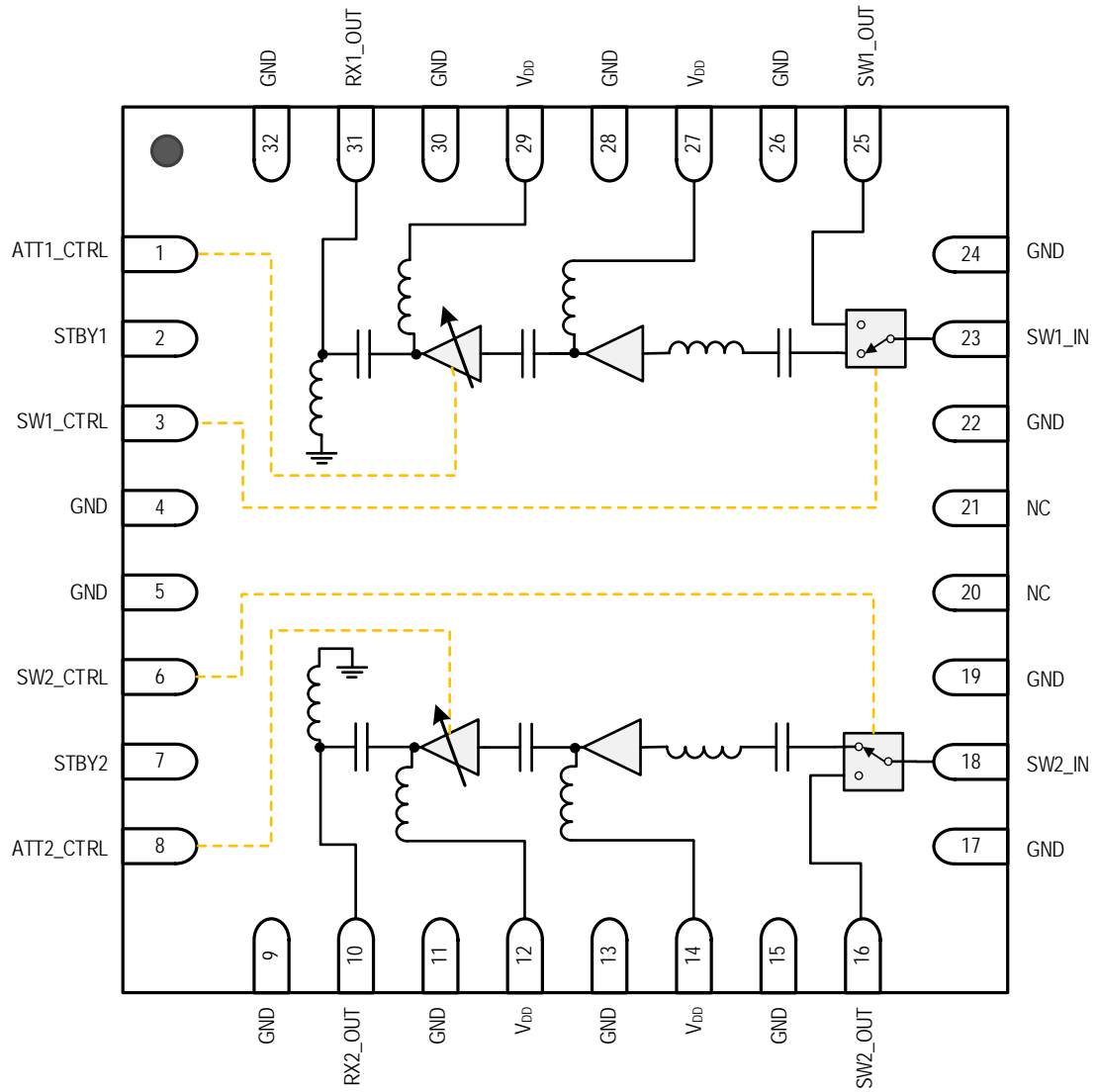

Pin Descriptions

Table 1. Pin Descriptions

| Number | Name | Description |
|---|-----------|--|
| 1 | ATT1_CTRL | 1-bit 6dB gain control for path 1. (Low /open = no attenuation; High = 6dB attenuation). A 500kΩ pull-down resistor is connected between this input and GND. |
| 2 | STBY1 | Standby (Low/open = path 1 power ON; High = path 1 power OFF). A 500kΩ pull-down resistor is connected between this input and GND. |
| 3 | SW1_CTRL | RF SWITCH 1 control (Low /open = select main RX PATH 1; High = switch output). SW1_CTRL also puts path 1 into Standby Mode for minimum current consumption. A 500kΩ pull-down resistor is connected between this input and GND. |
| 4, 5, 9, 11, 13, 15, 17, 19, 22, 24, 26, 28, 30, 32 | GND | Ground these pins. |
| 6 | SW2_CTRL | RF SWITCH 2 control (Low /open = select main RX PATH 2; High = switch output). SW2_CTRL also puts path 2 into Standby Mode for minimum current consumption. A 500kΩ pull-down resistor is connected between this input and GND. |
| 7 | STBY2 | Standby (Low /open = path 2 power ON; High = path 2 power OFF). A 500kΩ pull-down resistor is connected between this input and GND. |
| 8 | ATT2_CTRL | 1-bit 6dB gain control for path 2. (Low /open = no attenuation; High = 6dB attenuation). A 500kΩ pull-down resistor connects between this input and GND. |
| 10 | RX2_OUT | RF output path 2 matched to 50Ω. Use external DC block as close to the pin as possible. |
| 12, 14, 27, 29 | VDD | Power supply. Bypass to GND with capacitors shown in the F0452C Application Circuit as close as possible to the pins. |
| 16 | SW2_OUT | RF2 switch output matched to 50Ω. Use external 50Ω terminating resistor with proper power rating as required for the application. |
| 18 | SW2_IN | RF2 switch input matched to 50Ω. Use an external DC block as close to the pin as possible. |
| 23 | SW1_IN | RF1 switch input matched to 50Ω. Use an external DC block as close to the pin as possible. |
| 25 | SW1_OUT | RF1 switch output matched to 50Ω. Use an external 50Ω terminating resistor with proper power rating as required for the application. |
| 31 | RX1_OUT | RF output path 1 matched to 50Ω. Use an external DC block as close to the pin as possible. |
| 20, 21 | NC | These pins can be left unconnected, or be connected to ground (recommended). Use a via as close to the pin as possible if grounded. |
| — | EPAD | Exposed Pad. Internally connected to GND. Solder this exposed pad to a PCB pad that uses multiple ground vias to provide heat transfer out of the device into the PCB ground planes. These multiple via grounds are also required to achieve the specified RF performance. |

Absolute Maximum Ratings

Stresses beyond those listed below may cause permanent damage to the device. Functional operation of the device at these or any other conditions beyond those indicated in the operational section of this specification is not implied. Exposure to absolute maximum rating conditions for extended periods may affect device reliability.

Table 2. Absolute Maximum Ratings

| Parameter | Symbol | Minimum | Maximum | Units |
|---|---------------------|---------|------------------------|-------|
| V _{DD} to GND | V _{DD} | -0.3 | +3.6 | V |
| STBY1, STBY2, ATT1_CTRL, ATT2_CTRL, SW1_CTRL, SW2_CTRL to GND | V _{CTRL} | -0.3 | V _{DD} + 0.25 | V |
| SW1_IN, SW2_IN, RX1_OUT, RX2_OUT, SW1_OUT, SW2_OUT to GND Externally Applied DC Voltage | V _{SW} | -50 | 50 | mV |
| TX Mode CW Average Input Power +7.5dB PAR at SW1_IN, SW2_IN Ports, 10s, 89% Duty Cycle 50Ω, T _{EPAD} = 105°C [a], V _{DD} = +3.3V | P _{ABS_TX} | +31 | +33 [b] | dBm |
| RX Mode Average Input Power +7.5dB PAR at SW1_IN, SW2_IN Ports, 1 Hour Single Event, 50% Duty Cycle 50Ω, T _{EPAD} = 105°C [a], V _{DD} = +3.3V | P _{ABS_RX} | | +8 | dBm |
| Storage Temperature Range | T _{ST} | -65 | +150 | °C |
| Lead Temperature (soldering, 10s) | T _{LEAD} | | +260 | °C |
| Electrostatic Discharge – HBM (JEDEC/ESDA JS-001-2012) | V _{ESDHBM} | | 1500 (Class 1C) | V |
| Electrostatic Discharge – CDM (JEDEC JS-002-2014) ALL pins except pins 16, 18, 23, 25 | V _{ESDCDM} | | 500 (Class C2A) | V |
| Electrostatic Discharge – CDM (JEDEC JS-002-2014) Pins 16, 18, 23, 25 | V _{ESDCDM} | | 125 (Class C0B) | V |

[a] T_{EPAD} = temperature of the exposed paddle.

[b] RF input exposures greater than +31dBm and up to +33dBm for multiple extended periods will affect device reliability and lifetime if the maximum recommended input junction temperature is exceeded.

Recommended Operating Conditions

Table 3. Recommended Operating Conditions

| Parameter | Symbol | Condition | Minimum | Typical | Maximum | Units |
|--|---------------|----------------|---------|---------|--------------------|-------|
| Power Supply Voltage | V_{DD} | | 3.15 | 3.3 | 3.45 | V |
| Operating Temperature Range | T_{EPAD} | Exposed Paddle | -40 | | +105 | °C |
| RF Frequency Range | f_{RF} | | 2.3 | | 2.7 | GHz |
| TX Mode CW Average Input Power, +7.5dB PAR, Full Life Time ^[a] 50Ω, $V_{DD} = +3.3V$ | P_{MAX_TX} | 89% Duty Cycle | | | +30 ^[b] | dBm |
| RX Mode CW Average Input Power, +7.5dB PAR, Full Life Time ^[a] 50Ω, $V_{DD} = +3.3V$ | P_{MAX_RX} | 89% Duty Cycle | | | -25 | dBm |
| Port Impedance (SW1_IN, SW2_IN, RX1_OUT, RX2_OUT) | Z_{RF} | | | 50 | | Ω |
| Junction Temperature | T_J | | | | +125 | °C |

[a] Assumes device environmental temperature cycling within the specified exposed pad operating temperature range of -40°C and 105°C and a maximum junction temperature of 125°C.

[b] Operation beyond the maximum recommended operating input power level should be limited and have reduced exposed pad temperatures to maintain device reliability per foundry guidelines. Electrical characteristics and lifetime are not guaranteed for RF input power levels beyond what is specified in this table.

Electrical Characteristics

Table 4. Electrical Characteristics

See F0452C Application Circuit. Specifications apply when operated as an RX RF amplifier with $V_{DD} = +3.3V$, $T_{EPAD} = +25^{\circ}C$, $STBYX = Low$, RX output power = -10dBm, $Z_S = Z_L = 50\Omega$, and EVKit trace and connector losses are de-embedded unless otherwise noted.

| Parameter | Symbol | Condition | Minimum | Typical | Maximum | Units |
|--|-------------------|---|----------------------------|-----------|----------------------------|---------|
| Logic Input High Threshold | V_{IH} | | 1.17 ^[a] | | Lower of (V_{DD} , 3.3) | V |
| Logic Input Low Threshold | V_{IL} | | -0.3 | | 0.55 | V |
| Logic Current | I_{IH}, I_{IL} | For each control pin | -10 | | 10 | μA |
| DC Current | I_{DD} | 2 paths in RX Mode | | 130 | 180 | mA |
| | | 1 path in RX Mode 1 path in TX Mode | | 70 | 100 | |
| | | 1 path in RX Mode 1 path in Standby Mode | | 67 | | |
| | | 1 path in TX Mode 1 path in Standby Mode | | 5 | | |
| | | 2 paths in Standby Mode | | 5 | | |
| Gain Step | G_{STEP} | | | 6 | | dB |
| Gain Step Absolute Error | G_{STEP_ERR} | Relative to maximum gain, over-voltage, and temperature | | ± 0.5 | | dB |
| Relative Phase Gain Step | G_{STEP_PH} | | | 28 | | deg |
| Gain Step Settling Time ^[b] | G_{STEP_SET} | 50% control logic to RF output within ± 0.1 dB of final value | | 20 | 31 | ns |
| Gain Step Phase Settling Time ^[b] | G_{STEP_PHSET} | 50% control logic to RF output within ± 1 degree of final value | | 16 | 30 | ns |
| Power ON Switching Time ^[b] | SW_{ON} | To RX Mode from TX Mode 50% control logic to RF output settled to within ± 0.1 dB of final value | | | 1 | μs |
| Power OFF Switching Time ^[b] | SW_{OFF} | To TX Mode from RX Mode 50% control logic to RF input settled within ± 0.1 dB of final value | | | 0.5 | μs |

| Parameter | Symbol | Condition | Minimum | Typical | Maximum | Units |
|---|---------------------|---|---------|---------|---------|---------|
| Power ON from Standby Mode ^[b] | $SW_{ON_STANDBY}$ | To RX Mode from Standby Mode 50% STBYx to RF output settled within ± 0.1 dB of final value | | | 1 | μ s |
| Power OFF to Standby Mode ^[b] | $SW_{OFF_STANDBY}$ | To Standby Mode from RX Mode 50% STBYx to gain below -25dB from maximum gain | | | 1 | μ s |

[a] Items in the "Minimum"/"Maximum" columns in ***bold italics*** are confirmed by test. Items in the "Minimum"/"Maximum" columns not in bold italics are confirmed by design characterization.

[b] $f_{RF} = 2.6$ GHz. Assumes the control signal is clean and no external RC circuitry is required on the pin. Adding RC circuitry increases switching time. Timing tests performed with a control logic signal of +3.3V and a rise/fall time ≤ 30 ns.

Table 5. Electrical Characteristics – RX Path in RX Mode Cascaded Performance
 See the F0452C Application Circuit. Specifications apply when operated as an RX RF amplifier with $V_{DD} = +3.3V$, $f_{RF} = 2.6GHz$, $T_{EPAD} = +25^{\circ}C$, $STBYx = Low$, RX output power = -10dBm, $Z_S = Z_L = 50\Omega$, and EVKit trace and connector losses are de-embedded unless otherwise noted.

| Parameter | Symbol | Condition | Minimum | Typical | Maximum | Units |
|--|----------------------|---|-----------|-------------------|-----------|-------|
| Input Return Loss | RL _{IN} | Measured at SW1_IN, SW2_IN, High/Low Gain Mode, $f_{RF} = 2.4GHz$ | | 16 ^[a] | | dB |
| | | Measured at SW1_IN, SW2_IN, High/Low Gain Mode, $f_{RF} = 2.6GHz$ | | 20 | | |
| | | Measured at SW1_IN, SW2_IN, High/Low Gain Mode, $f_{RF} = 2.3GHz$ to $2.7GHz$ | 6 | | | |
| Output Return Loss | RL _{OUT} | Measured at RX1_OUT, RX2_OUT, High/Low Gain Modes, $f_{RF} = 2.3GHz$ to $2.7GHz$ | 7 | | | dB |
| Reverse Isolation, RX1_OUT to SW1_IN, or RX2_OUT to SW2_IN | ISO _{REV} | $f_{RF} = 2.3GHz$ to $2.7GHz$ | 50 | 58 | | dB |
| Gain | G _{HG} | High Gain Mode | 32 | 34 | 37 | dB |
| | G _{HG_TEMP} | $T_{EPAD} = -40^{\circ}C$ to $105^{\circ}C$ | 31 | | 38 | |
| Gain Attenuated | G _{LG} | Low Gain Mode | 25.5 | 28 | 31.5 | dB |
| Gain Ripple | G _{RIPPLE} | $f_{RF} = 2.3GHz$ to $2.7GHz$ (Difference between maximum and minimum gain in each 100MHz subrange within the specified frequency range) | | ± 0.75 | | dB |
| Noise Figure | NF | Measured at antenna port ideally matched to LNA | | 1.6 | 1.7 | dB |
| | | $T_{EPAD} = 105^{\circ}C$ | | | 2.3 | |
| | | Low Gain Mode | | 1.5 | | |

[a] Items in the "Minimum"/"Maximum" columns in **bold italics** are confirmed by test. Items in the "Minimum"/"Maximum" columns NOT in bold italics are confirmed by design characterization.

Table 6. Electrical Characteristics – RX Path in RX Mode Cascaded Performance and TX Performance
 See the F0452C Application Circuit. Specifications apply when operated as an RX RF amplifier with $V_{DD} = +3.3V$, $f_{RF} = 2.6GHz$, $T_{EPAD} = +25^{\circ}C$, $STBYx = Low$, RX output power = $-10dBm$, $Z_S = Z_L = 50\Omega$, and EVKit trace and connector losses are de-embedded unless otherwise noted.

| Parameter | Symbol | Condition | Minimum | Typical | Maximum | Units |
|------------------------------------|--------------------|--|---------|-------------------|---------|-------|
| Output Third-Order Intercept Point | OIP3 ₁ | Pout = 0dBm/tone 5MHz tone separation | | 23 ^[a] | | dBm |
| | OIP3 ₂ | Pout = 0dBm/tone 5MHz tone separation $T_{EPAD} = -40^{\circ}C$ to $105^{\circ}C$ | 20 | | | |
| | OIP3 ₃ | Pout = 0dBm/tone 5MHz tone separation Low Gain Mode | | 23 | | |
| | OIP3 ₄ | Pout = 0dBm/tone 5MHz tone separation Low Gain Mode $T_{EPAD} = -40^{\circ}C$ to $105^{\circ}C$ | 18 | | | |
| Output 1dB Compression | OP1dB ₁ | High Gain Mode ^[b] | | 15 | | dBm |
| | OP1dB ₂ | High Gain Mode $T_{EPAD} = -40^{\circ}C$ to $105^{\circ}C$ | 11 | | | |
| | OP1dB ₃ | Low Gain Mode | | 14 | | |
| | OP1dB ₄ | Low Gain Mode $T_{EPAD} = -40^{\circ}C$ to $105^{\circ}C$ | 10 | | | |
| Channel Isolation | ISO _{CH} | $RFISO_1 = \left(\frac{RX1_OUT}{RX2_OUT} \right)_{dB}$ with $-60 \leq SW1_IN \leq -30dBm$ $RFISO_2 = \left(\frac{RX2_OUT}{RX1_OUT} \right)_{dB}$ with $-60 \leq SW2_IN \leq -30dBm$ | 54 | 64 | | dB |
| RF Switch Isolation | ISO _{SW} | TX Mode Measured at SW_IN to RX_OUT of the same channel | 55 | 65 | | dB |

[a] Items in the "Minimum"/"Maximum" columns in **bold italics** are confirmed by test. Items in the "Minimum"/"Maximum" columns not in bold italics are confirmed by design characterization.

[b] In the OP1dB calculation formula, "G" denotes the gain of each part instance at the frequency of interest and appropriate HIGH / LOW gain state.

Thermal Characteristics

Table 7. Thermal Characteristics

| Parameter | Symbol | Value | Units |
|--|--------------------|-------|-------|
| Junction-to-Ambient Thermal Resistance | θ_{JA} | 31.2 | °C/W |
| Junction-to-Case Thermal Resistance (Case is defined as the exposed paddle) | θ_{JC_BOT} | 3.4 | °C/W |
| Moisture Sensitivity Rating (Per J-STD-020) | | MSL3 | |

Typical Operating Conditions

Unless otherwise noted:

- $V_{DD} = +3.3V$
- $T_{EPAD} = 25^{\circ}C$
- $Z_L = Z_S = 50\Omega$ single-ended with matching networks
- $STBY1 = STBY2 =$ Low or open
- $SW_CTRL =$ Low or open
- Gain Setting = High Gain Mode
- $P_{IN} \leq -30dBm$
- All temperatures are referenced to the exposed paddle
- Evaluation kit traces and connector losses are de-embedded

Programming

Table 8. Gain Step Truth Table

| ATT1_CTRL, ATT2_CTRL | Attenuation Setting |
|----------------------|---------------------|
| Low or NC | 0dB |
| High | 6dB |

Table 9. Standby and RF Switch Truth Table

In TX Mode, the amplifiers are Off but the bias will remain On for fast turn-on recovery time.

| STBY1, STBY2 | SW1_CTRL, SW2_CTRL | Mode | Amplifier State |
|--------------|--------------------|---------|-----------------|
| Low or NC | Low or NC | RX | On |
| Low or NC | High | TX | Off |
| High | High or Low or NC | Standby | Off |

Typical Performance Characteristics

Figure 2. Rx Mode Gain (High Gain)

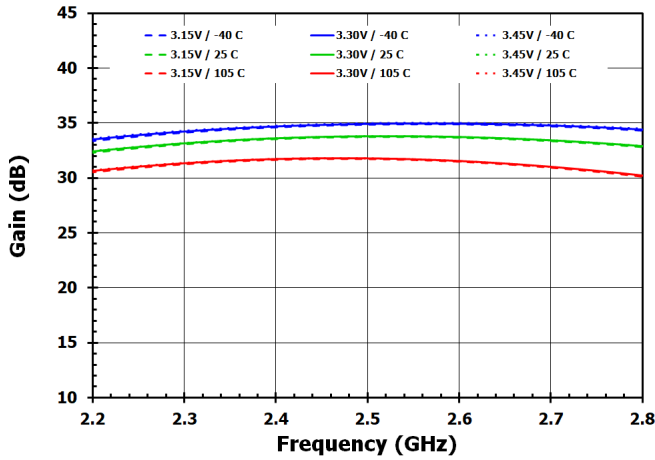

Figure 3. Rx Mode Gain (Low Gain)

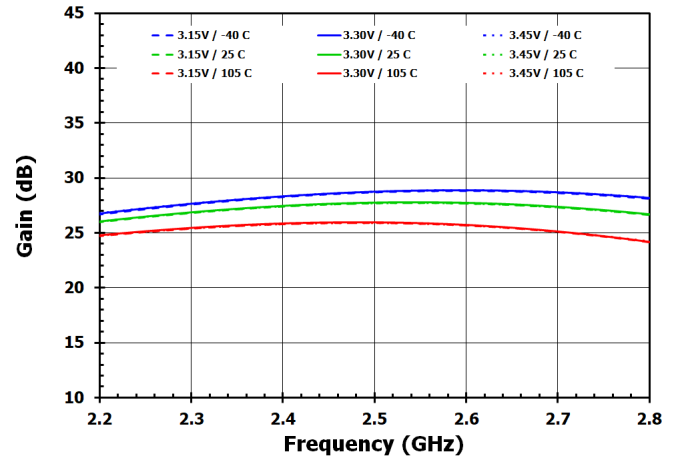

Figure 4. Rx Mode Reverse Isolation (High Gain)

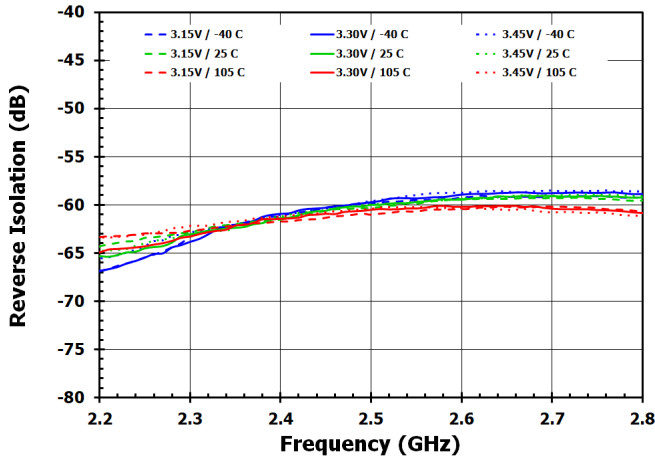

Figure 5. Rx Mode Reverse Isolation (Low Gain)

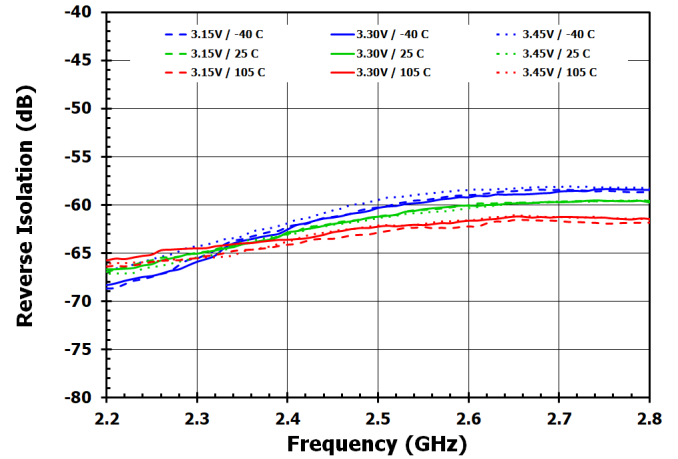

Figure 6. Rx Mode Input Return Loss (High Gain)

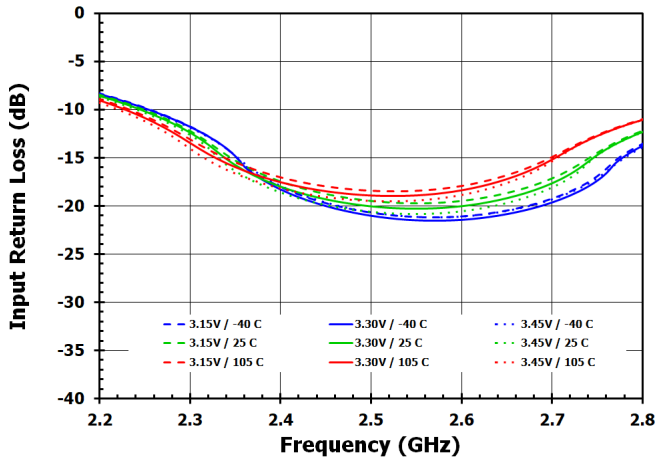

Figure 7. Rx Mode Input Return Loss (Low Gain)

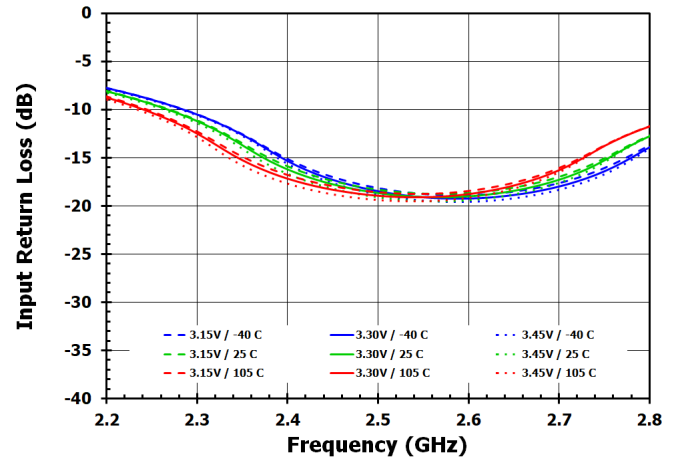

Figure 8. Rx Mode Output Return Loss (High Gain)

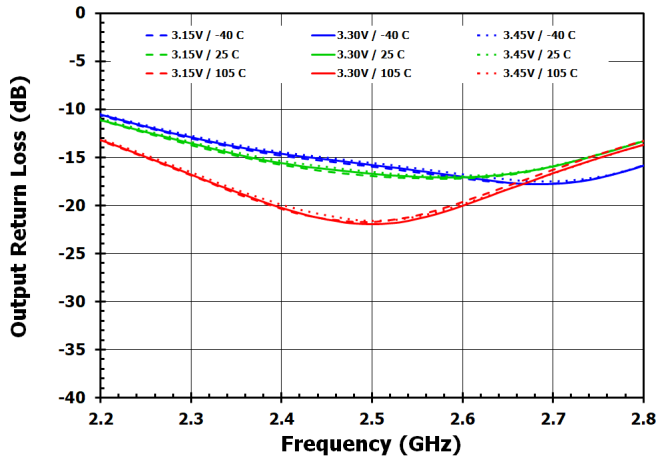

Figure 9. Rx Mode Output Return Loss (Low Gain)

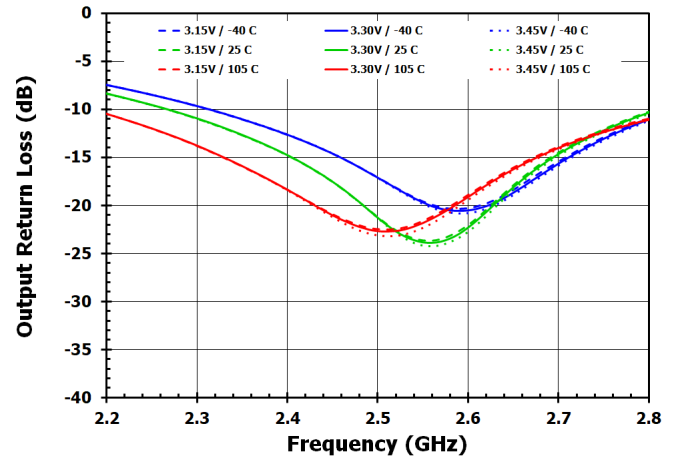

Figure 10. Rx Mode OP1dB (High Gain)

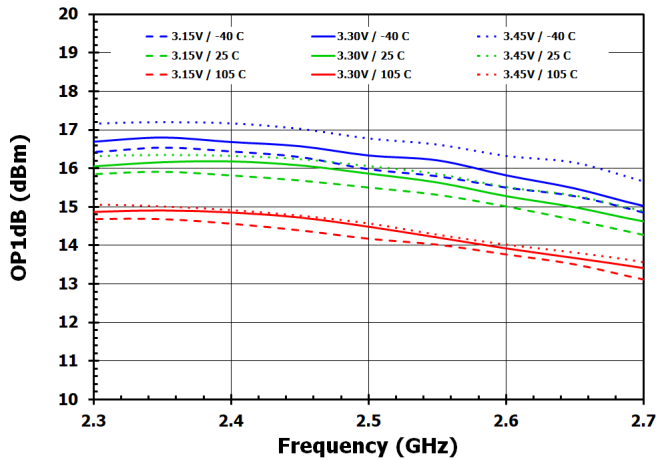

Figure 11. Rx Mode OP1dB (Low Gain)

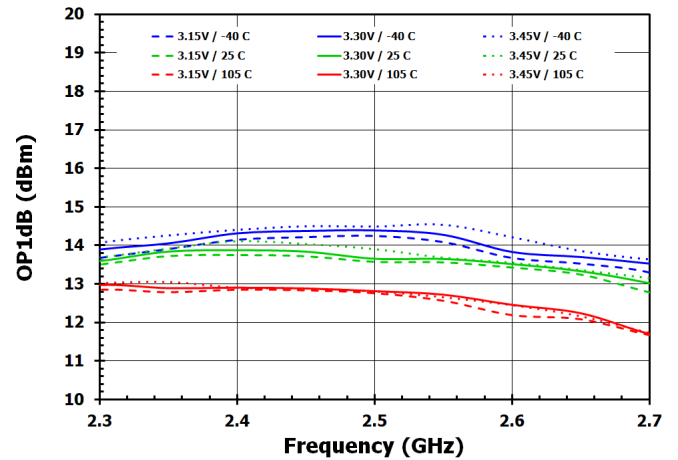

Figure 12. Rx Mode OIP3 (High Gain)

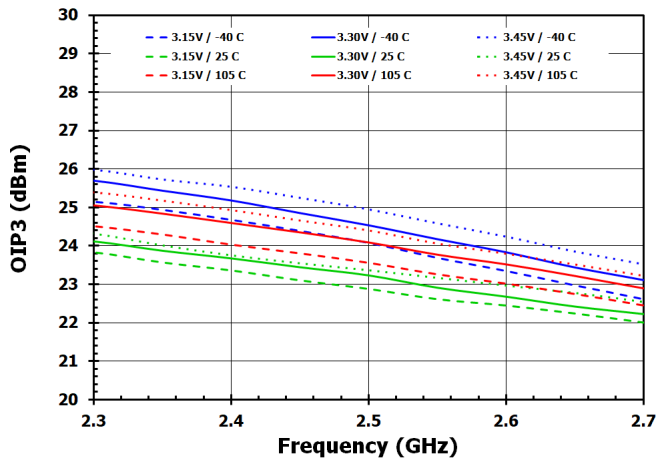

Figure 13. Rx Mode OIP3 (Low Gain)

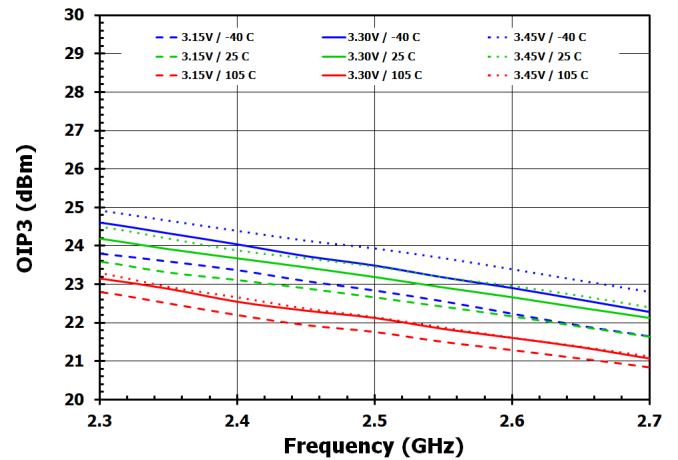

Figure 14. Rx Mode Noise Figure (High Gain)

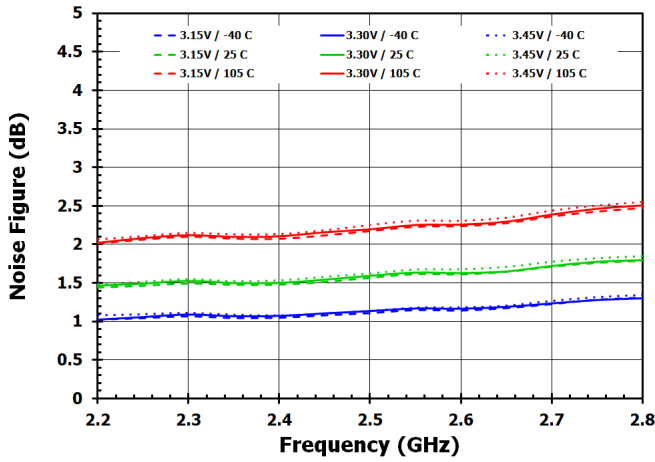

Figure 15. Rx Mode Noise Figure (Low Gain)

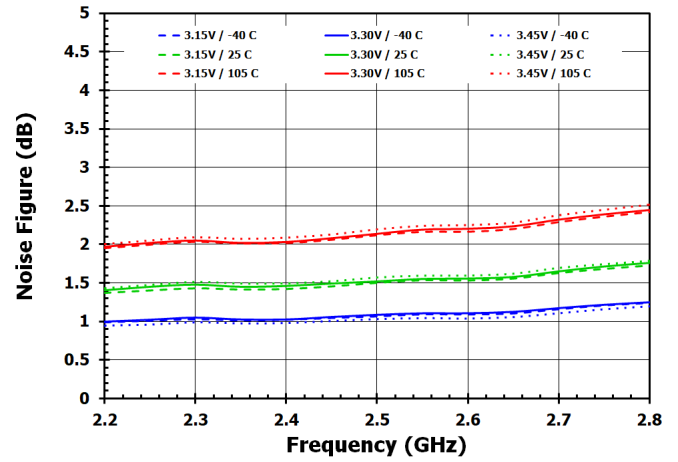

Figure 16. Tx Mode RF Switch Isolation

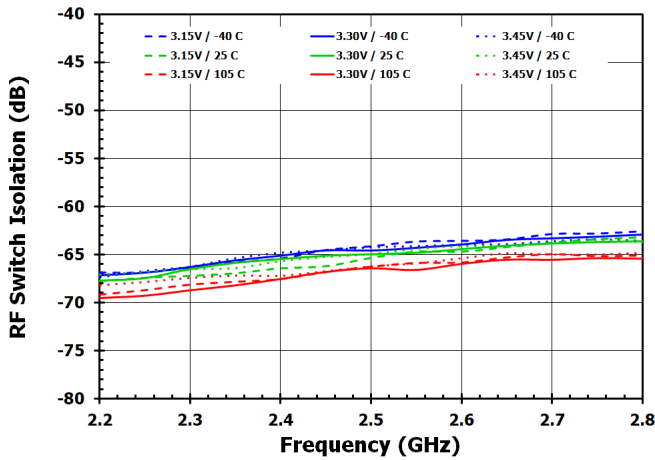

Figure 17. Rx Mode Channel Isolation

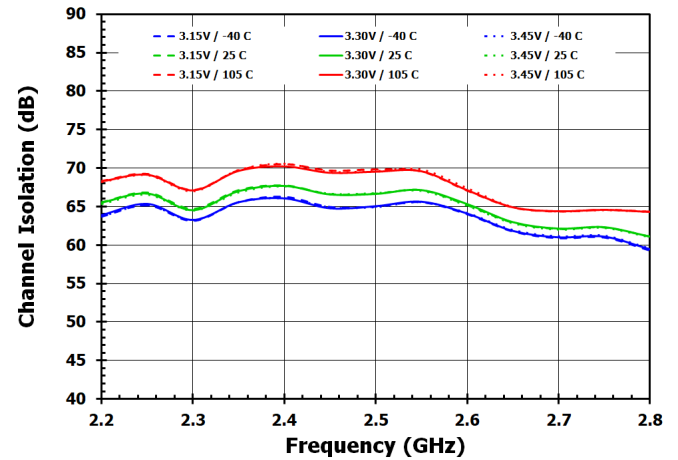

Figure 18. Stability Factor

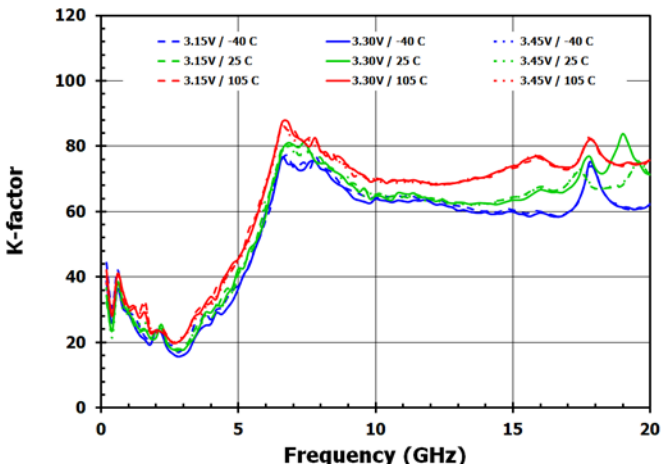

Figure 19. Gain Setting Time

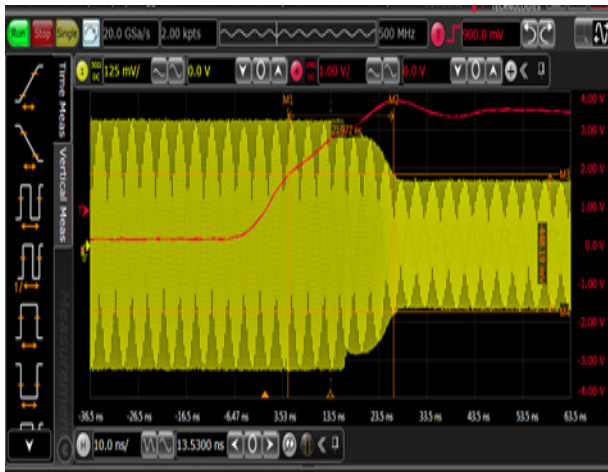

Figure 20. Gain Step Phase Settling Time



Figure 21. Power OFF Switching Time



Figure 22. Power ON Switching Time



Figure 23. Power OFF to Standby Mode

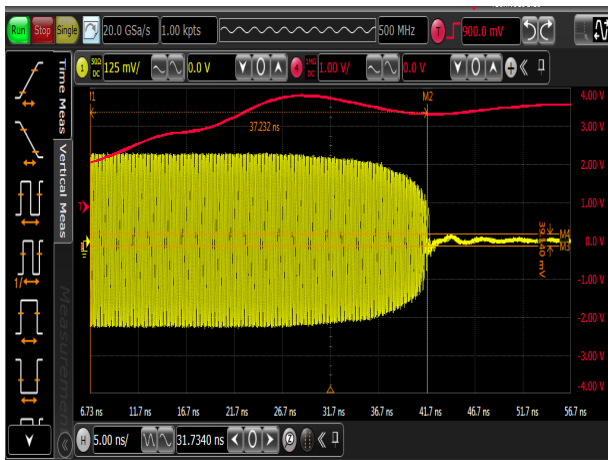
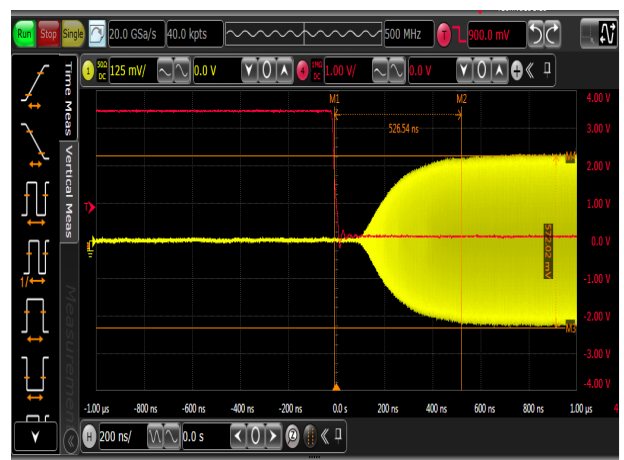

Figure 24. Power ON from Standby Mode



Evaluation Kit Circuit

Figure 28. Electrical Schematic

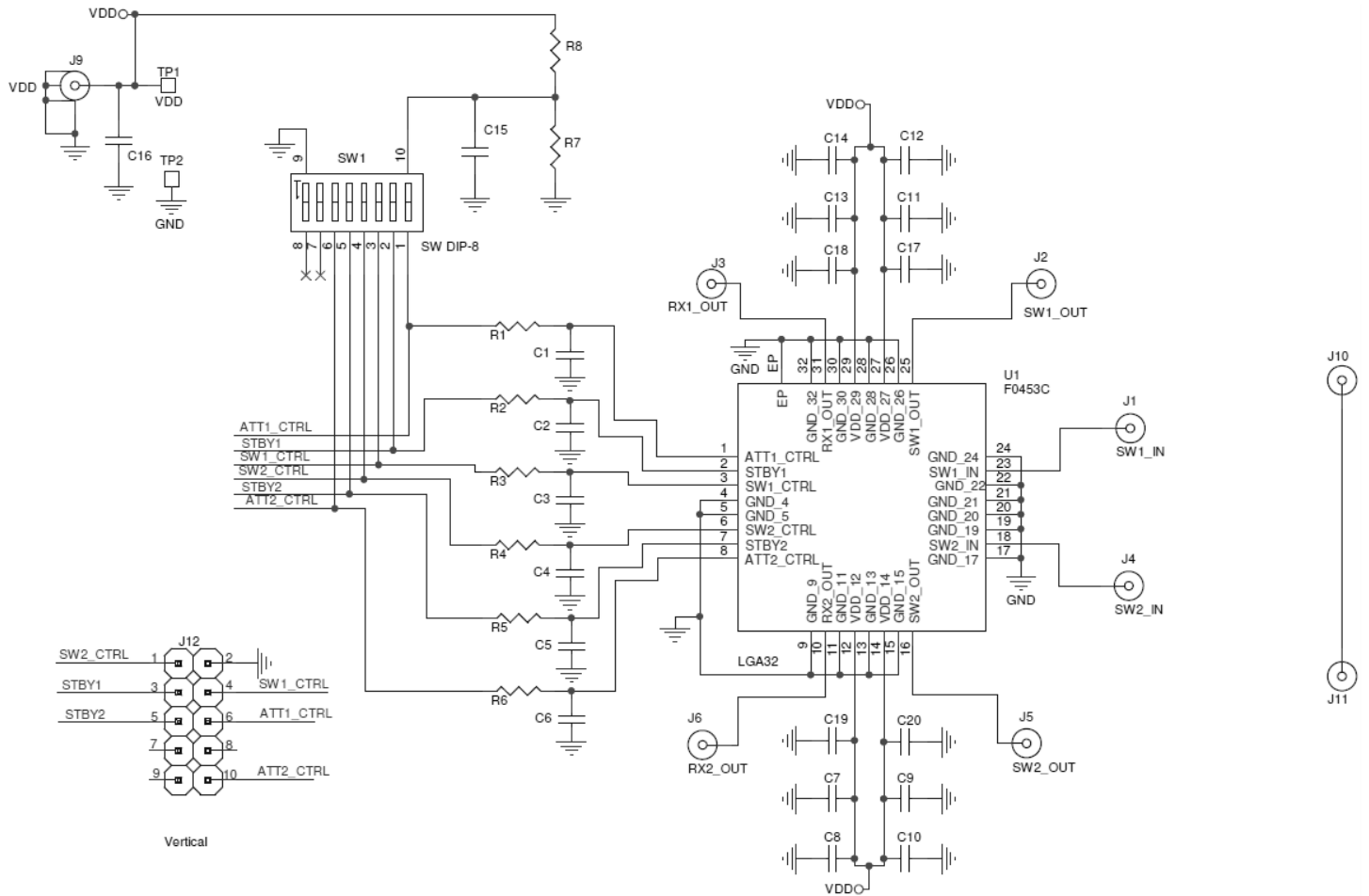
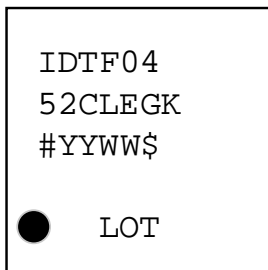

Table 10. Bill of Material (BOM)

| Part Reference | Qty | Description | Manufacturer Part # | Manufacturer |
|-------------------------------|-----|---|--------------------------------|-------------------------|
| C2,C3,C4,C5 | DNI | 100pF ±5%, 50V, C0G Ceramic Capacitor (0402) | GRM1555C1H101J | MURATA |
| C7,C9,C11,C13 | DNI | 10nF ±5%, 50V, X7R Ceramic Capacitor (0402) | GRM155R71H103J | MURATA |
| C8,C10,C12,C14 | 4 | 1µF ±10% 10V Ceramic Capacitor X5R 0402 | GRM155R61A105KE15D | MURATA |
| C17,C18,C19,C20 | 4 | 8pF ±0.1pF 50V Ceramic Capacitor C0G,NP0 (0402) | GJM1555C1H8R0B | MURATA |
| C15 | 1 | 10nF ±5%, 50V, X7R Ceramic Capacitor (0603) | GRM188R71H103K | MURATA |
| R1,R2,R3,R4,R5,R6 | 6 | 0Ω Resistors (0402) | ERJ-2GE0R00X | PANASONIC |
| R7 | 1 | 1kΩ ±1%, 1/10W, Resistor (0402) | ERJ-2RKF1001X | PANASONIC |
| R8 | 1 | 1.3kΩ ±1%, 1/10W, Resistor (0402) | ERJ-2RKF1301X | PANASONIC |
| J1,J2,J3,J4,J5,J6, J10,J11 | 8 | SMA Edge Mount | 142-0761-881 | Cinch Connectivity |
| J12 | 1 | CONN HEADER VERT 2X5 POS GOLD | 10-89-7100 | 3M |
| J9 | 1 | Edge Launch SMA(0.375 inch pitch ground, tab) (50Ohm) | 142-0701-851 | Emerson Johnson |
| SW1 | 1 | 8-pin DIP Switch (3 POS) | KAT1108E | IDE-Switch |
| U1 | 1 | Dual Path RF +LNA+DVGA 5x5 QFN | F0452C/F0453C LEG32K | Renesas (IDT) |
| PCB | 1 | Printed Circuit Board | F0452C/F0453C Stripline Rev. B | |
| TEST POINT | DNI | BLACK/GND TP1 | 5001 | Keystone Electronics |
| TEST POINT | DNI | RED/VCC TP2 | 5000 | Keystone Electronics |
| C1,C6,C16 | 3 | DNI | | |

Marking Diagram



- Lines 1 and 2 indicate the part number
- Line 3 indicates the following:
 - “#” denotes stepping
 - “YY” is the last two digits of the year; “WW” is the work week number when the part was assembled.
 - “\$” denotes the mark code.
- Line 4 is the lot number

Package Outline Drawings

The package outline drawings are located at the end of this document and are accessible from the Renesas website (see package links in Ordering Information). The package information is the most current data available and is subject to change without revision of this document.

Ordering Information

| Part Number | Package | MSL Rating | Carrier Type | Temp. Range |
|-------------|--|------------|--------------|----------------|
| F0452CLFGK | 6 × 6 × 0.75 mm 32-FCLGA | MSL3 | Tray | -40° to +105°C |
| F0452CLFGK8 | 6 × 6 × 0.75 mm 32-FCLGA | MSL3 | Reel | -40° to +105°C |
| F0452CEVB | Evaluation Board | | | |

Revision History

| Revision Date | Description of Change |
|-------------------|---|
| July 13, 2021 | <ul style="list-style-type: none"> ▪ Updated V_{IL} specification in Table 4. ▪ Completed other minor changes. |
| May 5, 2020 | Updated thickness package dimensions to match the POD dimensions. |
| April 21, 2020 | <ul style="list-style-type: none"> ▪ Updated Orderable Part Number Information. ▪ Added Application Section Information. |
| February 26, 2020 | Initial release. |

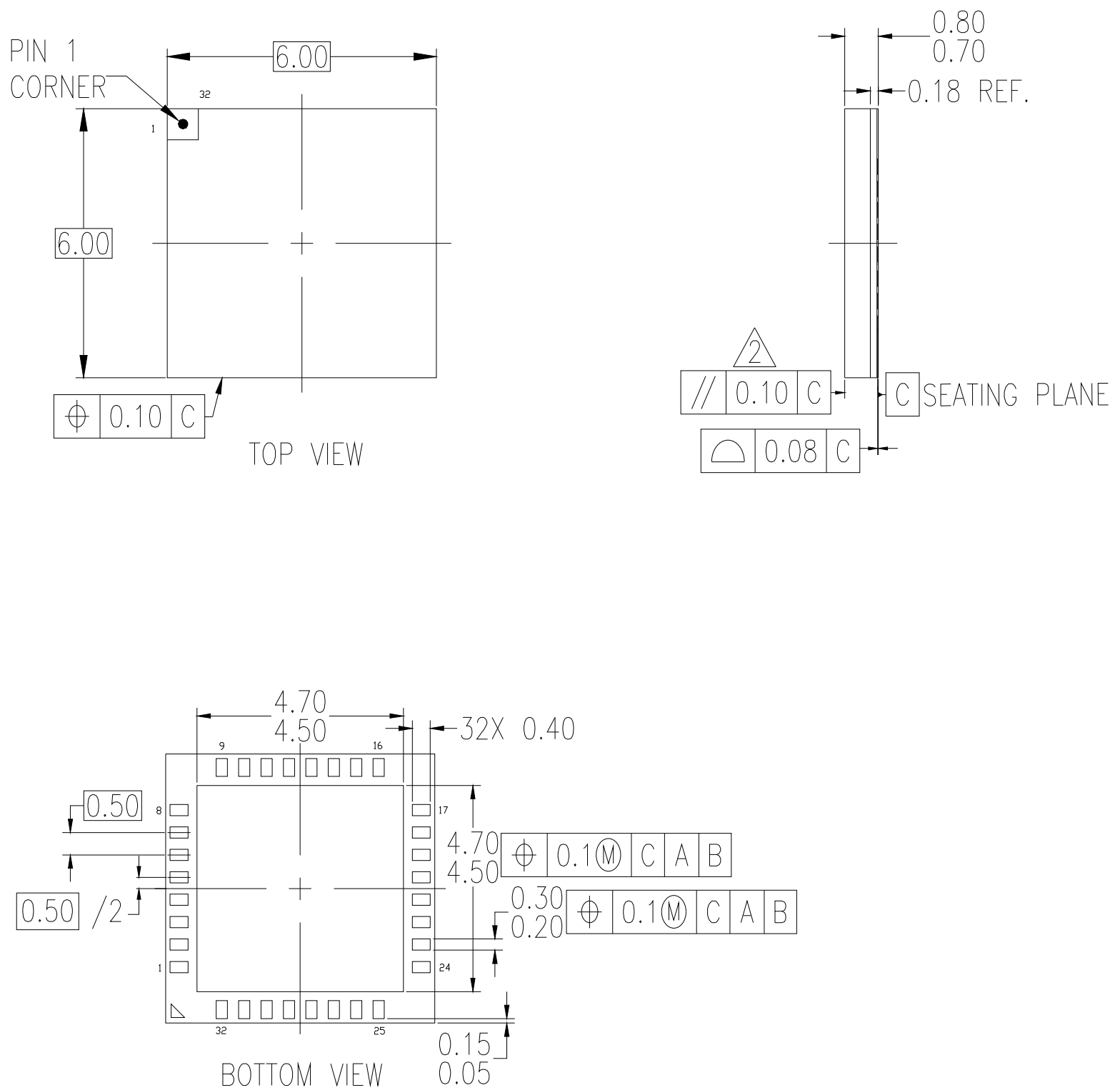

NOTES:

1. ALL DIMENSIONS IN MM.
- △ PARALLELISM MEASUREMENT SHALL EXCLUDE ANY EFFECT OF MARK ON TOP SURFACE OF PACKAGE.

IMPORTANT NOTICE AND DISCLAIMER

RENESAS ELECTRONICS CORPORATION AND ITS SUBSIDIARIES (“RENESAS”) PROVIDES TECHNICAL SPECIFICATIONS AND RELIABILITY DATA (INCLUDING DATASHEETS), DESIGN RESOURCES (INCLUDING REFERENCE DESIGNS), APPLICATION OR OTHER DESIGN ADVICE, WEB TOOLS, SAFETY INFORMATION, AND OTHER RESOURCES “AS IS” AND WITH ALL FAULTS, AND DISCLAIMS ALL WARRANTIES, EXPRESS OR IMPLIED, INCLUDING, WITHOUT LIMITATION, ANY IMPLIED WARRANTIES OF MERCHANTABILITY, FITNESS FOR A PARTICULAR PURPOSE, OR NON-INFRINGEMENT OF THIRD-PARTY INTELLECTUAL PROPERTY RIGHTS.

These resources are intended for developers who are designing with Renesas products. You are solely responsible for (1) selecting the appropriate products for your application, (2) designing, validating, and testing your application, and (3) ensuring your application meets applicable standards, and any other safety, security, or other requirements. These resources are subject to change without notice. Renesas grants you permission to use these resources only to develop an application that uses Renesas products. Other reproduction or use of these resources is strictly prohibited. No license is granted to any other Renesas intellectual property or to any third-party intellectual property. Renesas disclaims responsibility for, and you will fully indemnify Renesas and its representatives against, any claims, damages, costs, losses, or liabilities arising from your use of these resources. Renesas' products are provided only subject to Renesas' Terms and Conditions of Sale or other applicable terms agreed to in writing. No use of any Renesas resources expands or otherwise alters any applicable warranties or warranty disclaimers for these products.

(Disclaimer Rev.1.01)

Corporate Headquarters

TOYOSU FORESIA, 3-2-24 Toyosu,
Koto-ku, Tokyo 135-0061, Japan
www.renesas.com

Trademarks



Renesas and the Renesas logo are trademarks of Renesas Electronics Corporation. All trademarks and registered trademarks are the property of their respective owners.

Contact Information

For further information on a product, technology, the most up-to-date version of a document, or your nearest sales office, please visit www.renesas.com/contact-us/.

Looking for pricing, stock, or lifecycle information?

Click below to explore more details on WIN SOURCE:

-  [View F0453BLEGK on WIN SOURCE](#)
-  [Renesas Electronics America](#) Information

Optimize Your Supply Chain with WIN SOURCE Solutions

-  Global Sourcing Solution
-  Obsolete Management
-  Cost Control Management
-  Shortage Management
-  Alternative Solution
-  Excess Inventory Management