

Agilent MGA-425P8 GaAs Enhancement-mode PHEMT Power Amplifier in 2x2 mm² LPCC Package

Data Sheet

Description

Agilent Technologies's MGA-425P8 power amplifier is designed for wireless application in the 2–10 GHz frequency range. The PA has a high power efficiency (PAE) achieved through the use of Agilent Technologies's proprietary GaAs Enhancement-mode pHEMT process.

MGA-425P8 is housed in a miniature 2.0 x 2.0 x 0.75 mm 8-lead leadless-plastic-chip-carrier (LPCC) package. The compact footprint, low profile couple with the excellent thermal efficiency of the LPCC package makes the MGA-425P8 an ideal choice as power amplifier that saves board space.

On-chip bias circuitry allows operation from a single +3.3V power supply. The output of the amplifier is near to 50Ω (below 2:1 VSWR) around 4.9–5.8 GHz. This makes MGA-425P8 an ideal choice as power amplifier for broadband IEEE 802.11a system as well as other high performance wireless application in the 2–10 GHz frequency range.

One external resistor (RBias) is used to set the bias current of the device over a wide range.

This allows the designer to use the same part in several circuit positions and tailor the output power/linearity performance, and current consumption, to suit each position.

Pin Connections and Package Marking 2.0 x 2.0 x 0.75 mm 8-lead LPCC

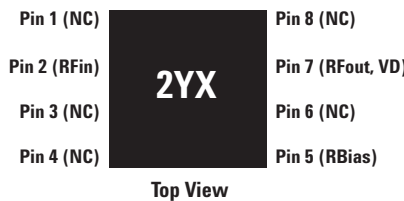

Note:

Package marking provides orientation and identification

"2Y" = Device Code

"X" = Data code indicates the month of manufacture.

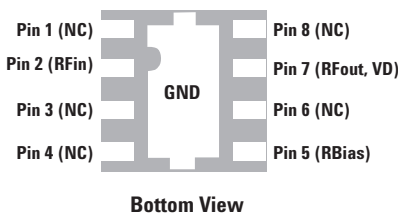

Note:

Use Die Attach Padded for electrical grounding and thermal dissipation

Simplified Schematic

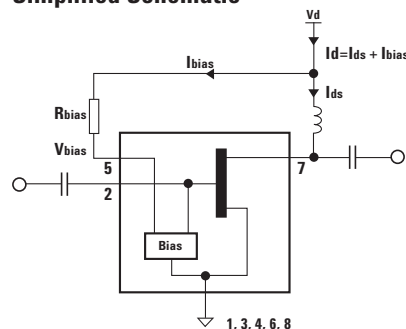

Features

- Near 50Ω broadband output match
- Single +3.3V supply
- High Gain & OIP3
- Miniature 2 x 2 x 0.75 mm LPCC package
- Pb-free & MSL-1 package
- Tape-and-Reel packaging option available

Specifications

at 5.25 GHz, 3.3V, 58 mA (typ)

- 13.3 dBm Linear Pout @ 5% EVM
- 10.3% PAE @ +13.3 dBm Pout
- 12 dBm Linear Pout @ 3% EVM
- 7.6% PAE @ +12 dBm Pout
- 47% PAE @ P1dB
- 20.3 dBm P1dB
- 32.9 dBm OIP3
- 16 dB Gain
- 1.7 dB NF



Attention:
Observe precautions for handling electrostatic sensitive devices.

ESD Machine Model (Class A)

ESD Human Body Model (Class 1A)

Refer to Agilent Application Note A004R: Electrostatic Discharge Damage and Control.



Agilent Technologies

MGA-425P8 Absolute Maximum Ratings^[1]

Symbol	Parameter	Units	Absolute Maximum
V_{DS}	Drain – Supply Voltage ^[2]	V	5
I_{DS}	Drain Current ^[2]	A	100
P_{diss}	Total Power Dissipation ^[3]	W	0.5
$P_{in\ max.}$	RF Input Power	dBm	13
T_{CH}	Channel Temperature	°C	150
T_{STG}	Storage Temperature	°C	-65 to 150
θ_{ch_b}	Thermal Resistance ^[4]	°C/W	34.2

Notes:

1. Operation of this device above any one of these parameters may cause permanent damage.
2. Assuming DC quiescent conditions.
3. Board (package belly) temperature T_B is 25°C. Derate 29 mW/°C for $T_B > 133$ °C.
4. Channel-to-board thermal resistance measured using 150°C Liquid Crystal Measurement method.

Product Consistency Distribution Charts at 5.25 GHz, 3.3V RBias = 680Ω^[5, 6]

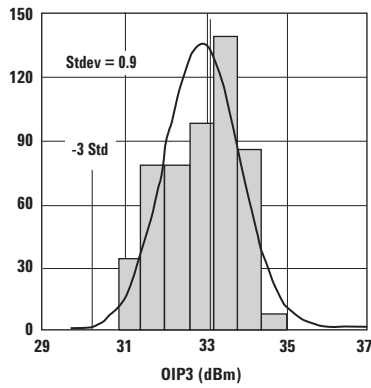

Figure 1. OIP3;
LSL = 29 dBm, Nominal = 32.9 dBm.

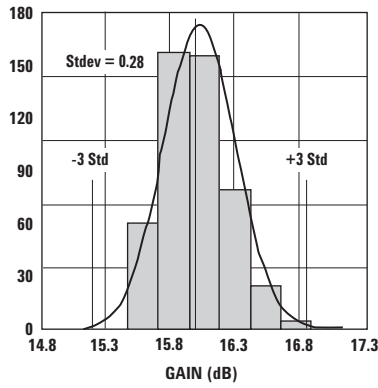

Figure 2. GAIN;
LSL = 14.5 dB, Nominal = 16 dB, USL = 17.5 dB.

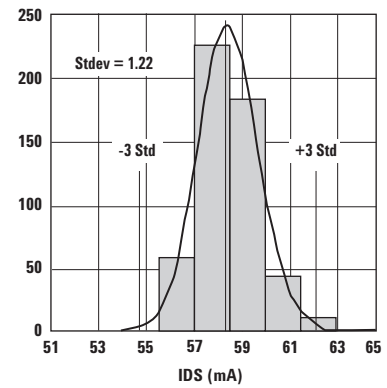

Figure 3. IDS;
LSL = 51 mA, Nominal = 58 mA, USL = 65 mA.

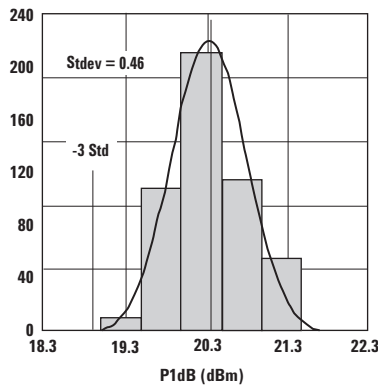

Figure 4. P1dB;
LSL = 18.25 dBm, Nominal = 20.3 dBm.

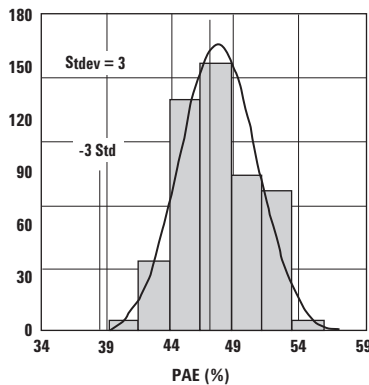

Figure 5. PAE;
LSL = 33.5 %, Nominal = 47 %.

Notes:

5. Distribution data sample size is 500 samples taken from 3 different wafers and 3 different lots. Future wafers allocated to this product may have nominal values anywhere between the upper and lower limits.
6. Measurements are made on production test board, which represents a trade-off between optimal OIP3, P1dB, Gain and VSWR. Circuit losses have been de-embedded from actual measurements.

MGA-425P8 Electrical Specifications

$T_A = 25^\circ\text{C}$, DC bias for RF parameter is $V_{ds} = 3.3\text{V}$ and $R_{bias} = 680\Omega$ (unless specified otherwise)

Symbol	Parameter and Test Condition	Units	Min.	Typ.	Max.
I_{ds}	Device Current	mA	51	58	65
G	Gain ^[1] Freq=5.25 GHz	dB	14.5	16	17.5
NF	Noise Figure ^[1] Freq=5.25 GHz	dB	–	1.7	–
OIP3	Output 3 rd Order Intercept Point ^[1,2] Freq=5.25 GHz	dBm	29	32.9	–
P1dB	Output 1dB Compressed ^[1] Freq=5.25 GHz	dBm	18.25	20.3	–
PAE	Power Added Efficiency ^[1] Freq=5.25 GHz	%	33.5	47	–
EVM	Error Vector Magnitude ^[3] at Pout=13.3 dBm	%	–	5	–
EVM	Error Vector Magnitude ^[3] at Pout=12 dBm	%	–	3	–

Notes:

- Measurement obtained using production test board described in Figure 6 and PAE tested at P1dB condition.
- 5.25GHz OIP3 test condition: $F_1 = 5.25\text{ GHz}$, $F_2 = 5.255\text{ GHz}$ and $P_{in} = -5\text{ dBm}$ per tone.
- EVM test condition: 802.11a 64QAM/54 Mbps OFDM Modulation and $\text{Freq} = 5.25\text{ GHz}$.

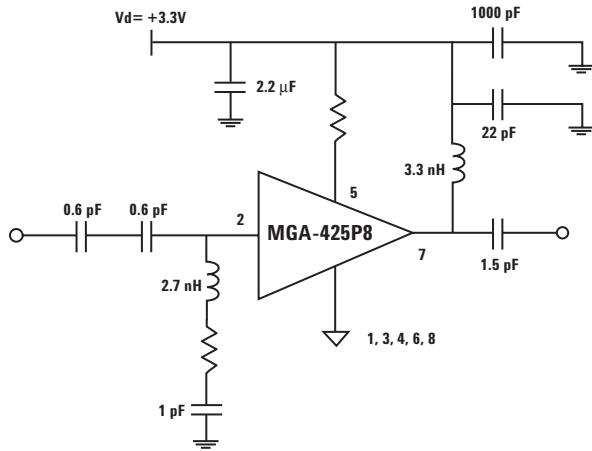

Figure 6. Simplified schematic of 5.25 GHz production test board used for Gain, NF, OIP3, P1dB, PAE and EVM measurements. This circuit achieves a trade-off between optimal OIP3, P1dB and VSWR. Circuit losses have been de-embedded from actual measurements.

MGA-425P8 Typical Performance Curves, $V_{ds} = 3.3V$, $I_{ds} = 58\text{ mA}$ (at 25°C unless specified otherwise)

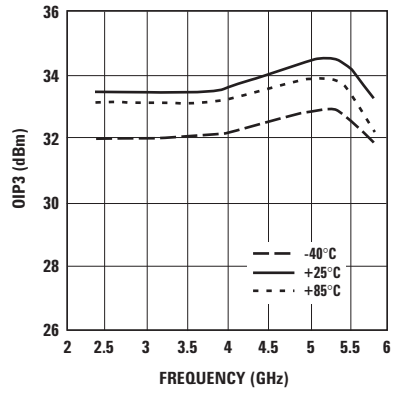

Figure 7. OIP3 vs. Temperature and Frequency.

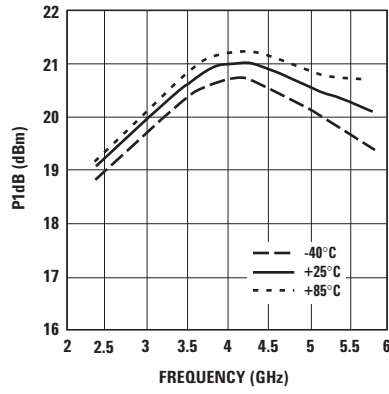

Figure 8. P1dB vs. Temperature and Frequency.

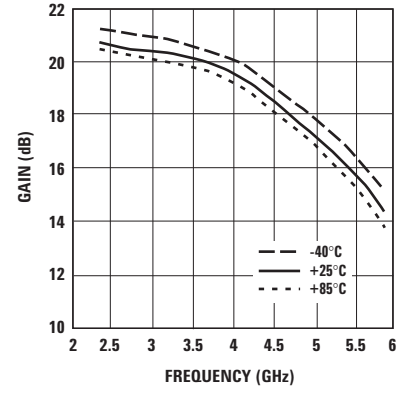

Figure 9. GAIN vs. Temperature and Frequency.

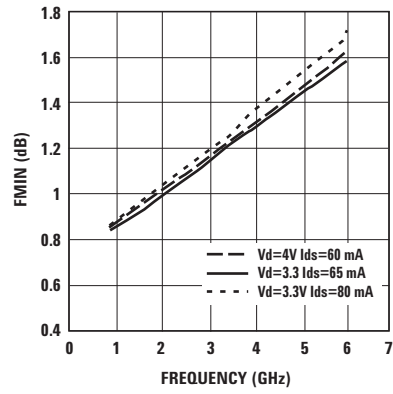

Figure 10. FMIN vs. Frequency.

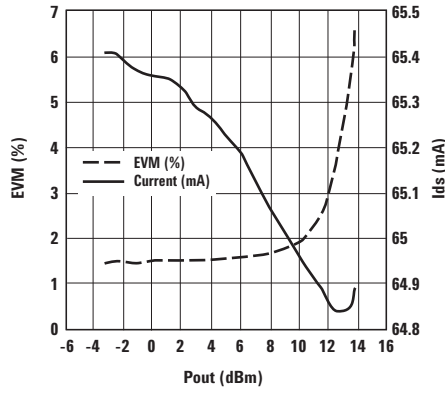

Figure 11. EVM and Current vs. Pout.

MGA-425P8 Typical Performance Curves, $V_{ds} = 3.3V$ (at 25°C unless specified otherwise)

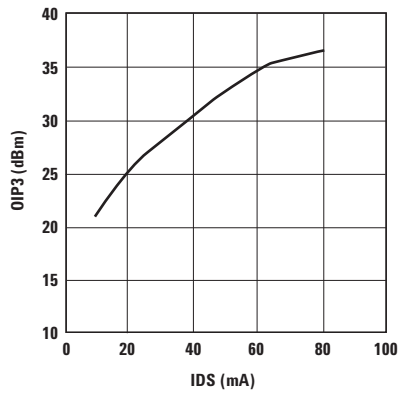

Figure 12. OIP3 vs. Ids at 5.25 GHz.

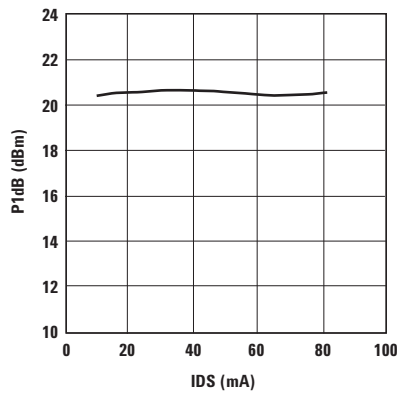

Figure 13. P1dB vs. Ids at 5.25 GHz.

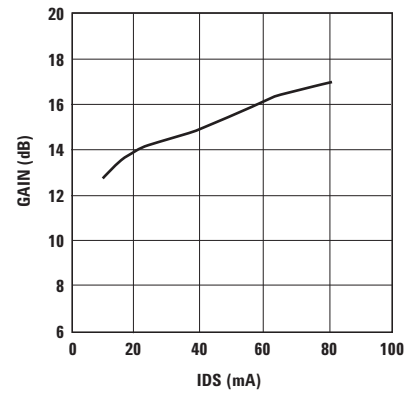

Figure 14. GAIN vs. Ids at 5.25 GHz.

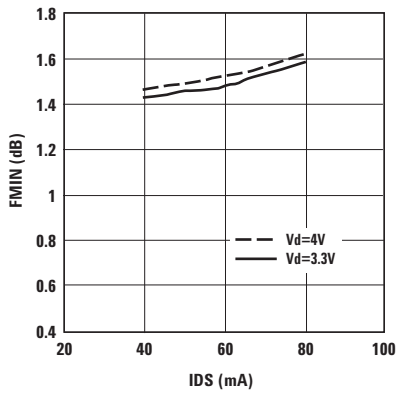

Figure 15. FMIN vs. Ids at 5.25 GHz.

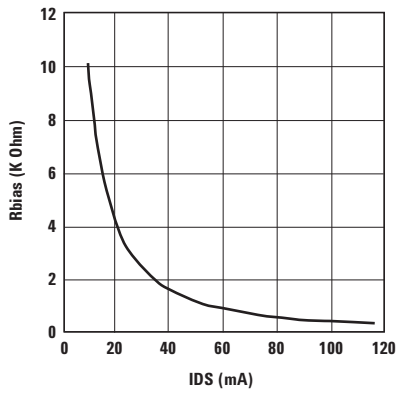

Figure 16. RBias vs. Ids ($V_{ds}=3.3V$).

MGA-425P8 Typical Scattering Parameters (at 25°C, $V_{DS} = 2V$, $I_{DS} = 20\text{ mA}$)

Freq. GHz	S_{11}			S_{21}			S_{12}			S_{22}		MSG/MAG
	Mag.	Ang.	dB	Mag.	Ang.	dB	Mag.	Ang.	Mag.	Ang.		
0.1	0.806	-15.3	24.42	16.629	171.6	-30.46	0.030	80.3	0.657	-8.9	32.67	
0.5	0.789	-59	22.96	14.066	147.5	-28.18	0.039	59.9	0.595	-37.6	25.57	
0.9	0.799	-92.7	21.38	11.723	128.5	-24.58	0.059	43.4	0.502	-62.6	22.98	
1	0.8	-99.5	20.95	11.156	124.4	-24.01	0.063	39.9	0.479	-68.2	22.48	
1.5	0.814	-126.2	18.87	8.784	107.8	-22.62	0.074	26.1	0.389	-93.3	20.74	
1.9	0.819	-141.1	17.34	7.365	97.5	-22.05	0.079	17.5	0.335	-110.1	19.70	
2	0.823	-144.8	16.94	7.03	94.8	-22.05	0.079	15.7	0.328	-115.4	19.49	
2.4	0.824	-155.7	15.56	5.999	86.7	-21.72	0.082	9.6	0.3	-129.4	18.64	
3	0.828	-168.1	13.77	4.881	76.4	-21.62	0.083	2.1	0.279	-147.1	17.69	
3.5	0.83	-176.3	12.50	4.216	69	-21.51	0.084	-2.8	0.268	-158	17.01	
3.9	0.827	178.3	11.55	3.778	63.2	-21.51	0.084	-6.9	0.269	-164.9	16.53	
4	0.84	176.9	11.23	3.643	63.2	-21.62	0.083	-6.3	0.272	-169.6	16.42	
4.5	0.834	170.7	10.34	3.288	56.4	-21.51	0.084	-10.8	0.267	-175.5	15.93	
5	0.837	164.9	9.48	2.977	50.6	-21.41	0.085	-14.2	0.266	177.8	15.44	
5.1	0.837	163.8	9.33	2.926	49.4	-21.41	0.085	-15	0.265	176.6	15.37	
5.2	0.836	162.7	9.17	2.875	48.2	-21.41	0.085	-15.7	0.263	175.7	15.29	
5.3	0.836	161.7	9.01	2.821	46.9	-21.41	0.085	-16.5	0.264	175	15.21	
5.4	0.835	160.6	8.86	2.772	45.7	-21.41	0.085	-17.2	0.265	173.8	15.13	
5.5	0.836	159.6	8.70	2.723	44.5	-21.41	0.085	-18.1	0.264	172.6	15.06	
5.6	0.836	158.6	8.56	2.679	43.2	-21.41	0.085	-18.9	0.262	171.6	14.99	
5.7	0.837	157.5	8.40	2.631	42	-21.41	0.085	-19.8	0.263	170.9	14.91	
5.8	0.836	156.4	8.25	2.584	40.6	-21.41	0.085	-20.7	0.264	170.1	14.83	
6	0.842	155.3	7.82	2.461	38.2	-21.51	0.084	-22.3	0.268	168.9	14.67	
7	0.846	144.7	6.40	2.09	27.5	-21.72	0.082	-28.8	0.281	158.9	14.06	
8	0.838	134.4	5.23	1.827	16.3	-21.41	0.085	-34.4	0.283	145.7	13.32	
9	0.842	123.3	4.30	1.641	6	-21.83	0.081	-42.6	0.322	132.3	13.07	
10	0.846	112.6	3.30	1.462	-6.9	-21.62	0.083	-49.9	0.366	115.3	12.46	
11	0.857	102.3	2.03	1.264	-17.6	-22.50	0.075	-56.5	0.391	102.3	9.68	
12	0.87	92.5	1.10	1.135	-28.5	-22.62	0.074	-63.9	0.44	96.1	9.62	
13	0.883	84	0.01	1.001	-39.5	-23.10	0.07	-70.6	0.482	89.3	9.26	
14	0.885	76.3	-1.15	0.876	-49.5	-23.61	0.066	-77.1	0.512	84.8	8.08	
15	0.893	69.3	-2.24	0.773	-58.2	-24.44	0.06	-82.5	0.534	81.7	7.30	
16	0.881	61	-3.19	0.693	-67.2	-24.73	0.058	-87.6	0.56	77.5	5.78	
17	0.87	53.2	-4.19	0.617	-75.9	-25.04	0.056	-91.7	0.583	72.1	4.36	
18	0.884	45.1	-5.32	0.542	-85.1	-26.74	0.046	-94.9	0.608	63.5	3.72	

Typical Noise Parameters, $V_{DS} = 2V$, $I_{DS} = 20\text{ mA}$

Freq GHz	F_{min} dB	Γ_{opt} Mag.	Γ_{opt} Ang.	$R_{n/50}$	NF @ 50 dB
0.9	0.9	0.09	-123.9	0.08	0.91
1.5	0.99	0.2	170.4	0.08	1.02
1.9	1.04	0.25	166.7	0.07	1.13
2	1.06	0.25	168.1	0.07	1.16
2.4	1.12	0.27	170.1	0.07	1.28
3	1.2	0.33	173.4	0.06	1.45
3.5	1.27	0.38	178	0.06	1.6
3.9	1.33	0.41	-179.5	0.06	1.71
4.5	1.41	0.45	-174.8	0.06	1.87
5	1.49	0.47	-171.6	0.06	2.04
5.2	1.51	0.48	-170.3	0.06	2.09
5.5	1.56	0.49	-167.3	0.06	2.18
5.8	1.6	0.51	-165	0.06	2.27
6	1.63	0.52	-163.4	0.06	2.33
7	1.77	0.54	-154.5	0.09	2.62
8	1.91	0.56	-143.5	0.14	2.95
9	2.05	0.58	-131.6	0.24	3.18
10	2.16	0.61	-120.2	0.32	3.56

Note:

- S Parameter is measured on a microstrip line made on 0.025 inch thick alumina carrier. The input reference plane is at the end of the gate lead. The output reference plane is at the end of the drain lead.

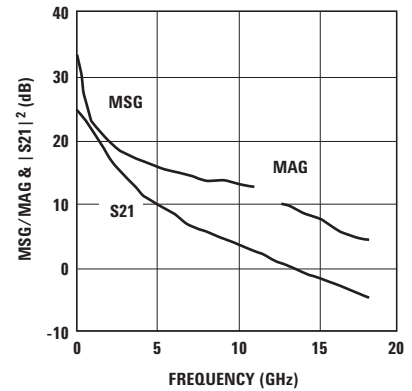

Figure 17. MSG/MAG & $|S_{21}|^2$ vs. Frequency at 2V, 20 mA.

MGA-425P8 Typical Scattering Parameters (at 25°C, $V_{DS} = 3.3V$, $I_{DS} = 40\text{ mA}$)

Freq. GHz	S_{11}		S_{21}			S_{12}		S_{22}		MSG/MAG	
	Mag.	Ang.	dB	Mag.	Ang.	dB	Mag.	Ang.	Mag.		Ang.
0.1	0.8	-16.1	26.67	21.547	171.2	-33.15	0.022	80	0.655	-8.3	34.88
0.5	0.791	-63.6	25.06	17.9	145.4	-31.06	0.028	58.6	0.579	-34.2	28.06
0.9	0.806	-98.2	23.26	14.559	125.9	-27.54	0.042	42.4	0.469	-55.3	25.40
1	0.807	-105	22.79	13.783	121.9	-27.13	0.044	39.1	0.443	-59.8	24.96
1.5	0.822	-131	20.55	10.655	105.6	-25.68	0.052	26.4	0.339	-79.6	23.12
1.9	0.828	-145.2	18.97	8.877	95.7	-25.35	0.054	18.8	0.274	-92.5	22.16
2	0.832	-148.7	18.56	8.47	93.1	-25.19	0.055	17.3	0.264	-97.4	21.88
2.4	0.835	-159	17.15	7.199	85.3	-25.04	0.056	12	0.226	-109.4	21.09
3	0.841	-170.8	15.32	5.836	75.2	-24.73	0.058	5.8	0.193	-126.1	20.03
3.5	0.843	-178.6	14.03	5.03	68.1	-24.73	0.058	1.6	0.176	-136.1	19.38
3.9	0.84	176.2	13.05	4.495	62.3	-24.73	0.058	-1.9	0.177	-143.3	18.89
4	0.852	174.9	12.73	4.328	62.6	-24.73	0.058	-0.8	0.17	-151.1	18.73
4.5	0.847	168.8	11.84	3.909	55.8	-24.73	0.058	-4.6	0.168	-154.8	18.29
5	0.85	163.3	10.98	3.54	50.3	-24.58	0.059	-7.2	0.165	-161.5	17.78
5.1	0.851	162.2	10.83	3.481	49.1	-24.58	0.059	-7.8	0.163	-162.4	17.71
5.2	0.85	161.2	10.68	3.419	47.9	-24.58	0.059	-8.4	0.163	-162.7	17.63
5.3	0.85	160.1	10.52	3.356	46.7	-24.44	0.06	-9.1	0.165	-163.2	17.48
5.4	0.85	159.1	10.37	3.298	45.5	-24.44	0.06	-9.7	0.166	-164.6	17.40
5.5	0.849	158.1	10.21	3.239	44.3	-24.44	0.06	-10.4	0.165	-165.7	17.32
5.6	0.849	157.1	10.07	3.187	43	-24.44	0.06	-11	0.165	-166.1	17.25
5.7	0.851	156	9.91	3.129	41.8	-24.44	0.06	-11.8	0.167	-166.5	17.17
5.8	0.85	155.1	9.75	3.074	40.5	-24.44	0.06	-12.6	0.169	-167.5	17.10
6	0.855	153.9	9.32	2.923	38	-24.58	0.059	-14	0.178	-168.2	16.95
7	0.863	143.6	7.96	2.5	27.5	-24.73	0.058	-18.8	0.191	178.9	16.35
8	0.855	133.6	6.79	2.185	16.4	-24.15	0.062	-23.7	0.188	164.8	15.47
9	0.861	122.5	5.88	1.968	5.9	-24.58	0.059	-30.7	0.217	146.6	13.95
10	0.866	111.9	4.91	1.759	-6.8	-24.15	0.062	-36.9	0.258	125.7	12.79
11	0.875	101.7	3.65	1.523	-17.8	-25.04	0.056	-42.1	0.286	109.9	11.07
12	0.89	91.9	2.73	1.37	-28.7	-24.88	0.057	-48.7	0.34	104.1	11.12
13	0.902	83.4	1.67	1.212	-40	-25.19	0.055	-54.3	0.392	97	10.81
14	0.905	75.7	0.51	1.061	-50.5	-25.51	0.053	-60.6	0.435	92.2	9.88
15	0.912	68.7	-0.58	0.935	-59.6	-26.38	0.048	-64.5	0.468	88.9	9.13
16	0.899	60.3	-1.60	0.832	-69.1	-26.38	0.048	-69.9	0.5	84.4	7.47
17	0.886	52.7	-2.62	0.74	-78	-26.38	0.048	-73.8	0.529	78.4	5.93
18	0.897	44.6	-3.77	0.648	-87.6		0.04	-74.3	0.555	69.3	5.16

Typical Noise Parameters, $V_{DS} = 3.3V$, $I_{DS} = 40\text{ mA}$

Freq GHz	F_{min} dB	Γ_{opt} Mag.	Γ_{opt} Ang.	$R_{n/50}$	NF @ 50 dB
0.9	0.84	0.1	-125.5	0.08	0.84
1.5	0.92	0.23	-176.4	0.08	0.97
1.9	0.98	0.26	-179.7	0.07	1.09
2	0.99	0.26	-180.2	0.07	1.11
2.4	1.04	0.29	-177.9	0.07	1.24
3	1.13	0.34	-179.3	0.06	1.35
3.5	1.19	0.38	-175.3	0.06	1.52
3.9	1.25	0.41	-173.3	0.06	1.62
4.5	1.33	0.46	-169.4	0.06	1.81
5	1.39	0.47	-166.5	0.06	1.92
5.2	1.42	0.48	-164.7	0.06	1.98
5.5	1.46	0.49	-162.3	0.06	2.06
5.8	1.5	0.5	-160.9	0.06	2.14
6	1.53	0.5	-158.4	0.06	2.2
7	1.66	0.52	-151	0.09	2.47
8	1.8	0.52	-141.8	0.14	2.76
9	1.93	0.54	-128.2	0.24	3.02
10	2.07	0.6	-117.3	0.32	3.31

Note:

- S Parameter is measured on a microstrip line made on 0.025 inch thick alumina carrier. The input reference plane is at the end of the gate lead. The output reference plane is at the end of the drain lead.

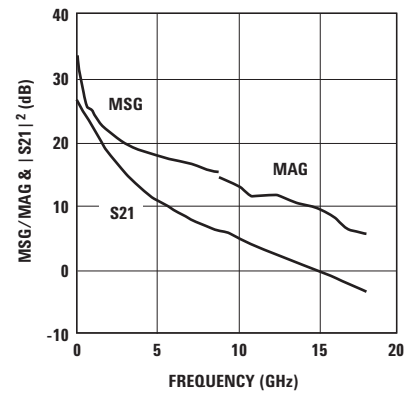

Figure 18. MSG/MAG & $|S_{21}|^2$ vs. Frequency at 3.3V, 40 mA.

MGA-425P8 Typical Scattering Parameters (at 25°C, $V_{DS} = 3.3V$, $I_{DS} = 58 mA$)

Freq. GHz	S_{11}		S_{21}			S_{12}		S_{22}		MSG/MAG	
	Mag.	Ang.	dB	Mag.	Ang.	dB	Mag.	Ang.	Mag.		Ang.
0.1	0.796	-16.4	27.39	23.407	171	-33.15	0.022	79.7	0.632	-8.4	35.91
0.5	0.792	-65.5	25.72	19.324	144.5	-31.70	0.026	58	0.554	-34.4	28.71
0.9	0.807	-100.5	23.83	15.548	124.8	-28.40	0.038	41.9	0.443	-55.1	26.12
1	0.809	-107.2	23.34	14.687	120.8	-27.96	0.04	38.7	0.418	-59.4	25.65
1.5	0.825	-132.9	21.04	11.266	104.7	-26.74	0.046	26.5	0.316	-78.4	23.89
1.9	0.83	-146.9	19.42	9.355	95.1	-26.38	0.048	19.2	0.253	-90.6	22.90
2	0.836	-150.3	19.01	8.923	92.5	-26.20	0.049	17.9	0.244	-95.4	22.60
2.4	0.838	-160.3	17.58	7.571	84.9	-26.02	0.05	12.9	0.208	-107	21.80
3	0.844	-171.8	15.75	6.134	75	-25.85	0.051	7.3	0.177	-123.3	20.80
3.5	0.846	-179.5	14.47	5.289	68	-25.68	0.052	3.4	0.161	-133.1	20.07
3.9	0.844	175.4	13.49	4.727	62.3	-25.68	0.052	0.1	0.164	-140.4	19.59
4	0.855	174.2	13.16	4.549	62.6	-25.68	0.052	1.3	0.156	-149	19.42
4.5	0.852	168.2	12.28	4.112	55.8	-25.68	0.052	-2.1	0.154	-152.4	18.98
5	0.855	162.7	11.42	3.722	50.4	-25.51	0.053	-4.5	0.151	-159	18.47
5.1	0.855	161.6	11.26	3.658	49.1	-25.51	0.053	-5.1	0.15	-159.8	18.39
5.2	0.854	160.6	11.11	3.593	48	-25.35	0.054	-5.7	0.149	-160	18.23
5.3	0.854	159.6	10.95	3.527	46.8	-25.35	0.054	-6.3	0.151	-160.4	18.15
5.4	0.855	158.5	10.79	3.465	45.6	-25.35	0.054	-6.9	0.153	-161.8	18.07
5.5	0.854	157.5	10.64	3.404	44.3	-25.35	0.054	-7.5	0.152	-162.9	18.00
5.6	0.854	156.5	10.50	3.348	43.1	-25.35	0.054	-8.2	0.151	-163.2	17.92
5.7	0.855	155.5	10.33	3.286	41.9	-25.35	0.054	-8.8	0.154	-163.5	17.84
5.8	0.854	154.5	10.18	3.228	40.6	-25.35	0.054	-9.6	0.156	-164.5	17.77
6	0.859	153.5	9.74	3.07	38.2	-25.51	0.053	-10.8	0.166	-165.1	17.63
7	0.867	143.2	8.38	2.625	27.9	-25.51	0.053	-15.3	0.179	-178.4	16.95
8	0.86	133.3	7.22	2.295	16.8	-24.88	0.057	-19.9	0.176	167.7	16.05
9	0.866	122.2	6.32	2.069	6.4	-25.35	0.054	-26.4	0.203	148.4	14.25
10	0.871	111.7	5.33	1.847	-6.3	-24.73	0.058	-32.5	0.243	126.9	13.24
11	0.881	101.5	4.07	1.598	-17.3	-25.68	0.052	-37	0.271	110.5	11.57
12	0.895	91.7	3.16	1.439	-28.2	-25.35	0.054	-43.8	0.325	104.9	11.61
13	0.909	83.3	2.10	1.273	-39.4	-25.68	0.052	-49.1	0.377	97.8	11.45
14	0.912	75.6	0.93	1.113	-49.9	-26.02	0.05	-55.6	0.421	93.2	10.51
15	0.919	68.6	-0.16	0.982	-58.8	-26.74	0.046	-59.2	0.456	89.9	9.82
16	0.904	60.2	-1.17	0.874	-68.4	-26.74	0.046	-64.7	0.489	85.5	7.97
17	0.89	52.5	-2.18	0.778	-77.3	-26.74	0.046	-68.7	0.518	79.7	6.37
18	0.902	44.4	-3.35	0.68	-86.9	-28.18	0.039	-68.1	0.547	70.5	5.65

Typical Noise Parameters, $V_{DS} = 3.3V$, $I_{DS} = 58 mA$

Freq GHz	F_{min} dB	Γ_{opt} Mag.	Γ_{opt} Ang.	$R_{n/50}$	NF @ 50 dB
0.9	0.85	0.1	-134	0.06	0.82
1.5	0.93	0.25	-177.4	0.06	1.01
1.9	0.98	0.27	-179.1	0.06	1.1
2	1	0.28	-179.9	0.06	1.13
2.4	1.06	0.3	-179.5	0.06	1.25
3	1.14	0.36	-176.8	0.05	1.41
3.5	1.23	0.41	-173.3	0.05	1.58
3.9	1.27	0.43	-171.3	0.06	1.69
4.5	1.36	0.48	-166.7	0.06	1.89
5	1.43	0.48	-164.4	0.06	2.02
5.2	1.46	0.49	-162.9	0.06	2.09
5.5	1.51	0.5	-160.5	0.07	2.17
5.8	1.55	0.5	-159	0.07	2.26
6	1.58	0.51	-157.5	0.07	2.32
7	1.75	0.53	-149.7	0.1	2.61
8	1.88	0.55	-140.3	0.15	2.94
9	2.03	0.56	-127.1	0.26	3.25
10	2.16	0.62	-115.8	0.36	3.59

Note:

- S Parameter is measured on a microstrip line made on 0.025 inch thick alumina carrier. The input reference plane is at the end of the gate lead. The output reference plane is at the end of the drain lead.

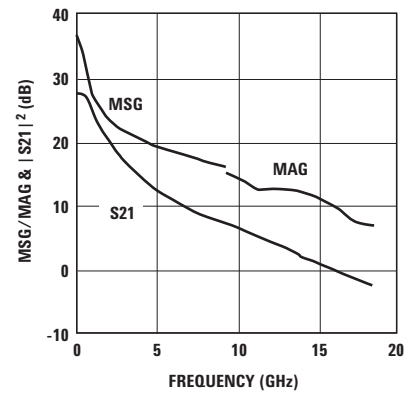

Figure 19. MSG/MAG & $|S_{21}|^2$ vs. Frequency at 3.3V, 58 mA.

MGA-425P8 Typical Scattering Parameters (at 25°C, $V_{DS} = 3.3V$, $I_{DS} = 65 mA$)

Freq. GHz	S_{11}		S_{21}			S_{12}		S_{22}		MSG/MAG	
	Mag.	Ang.	dB	Mag.	Ang.	dB	Mag.	Ang.	Mag.		Ang.
0.1	0.795	-16.4	27.50	23.716	171.1	-33.98	0.02	79.4	0.63	-8.4	35.97
0.5	0.792	-65.6	25.84	19.578	144.4	-32.04	0.025	58	0.552	-34.1	28.94
0.9	0.808	-100.7	23.94	15.736	124.7	-28.64	0.037	41.9	0.441	-54.5	26.29
1	0.81	-107.5	23.44	14.861	120.8	-28.18	0.039	38.7	0.415	-58.8	25.81
1.5	0.825	-133.1	21.13	11.389	104.7	-26.94	0.045	26.7	0.314	-77.3	24.03
1.9	0.83	-147	19.51	9.454	95.1	-26.56	0.047	19.4	0.251	-89.1	23.04
2	0.836	-150.4	19.10	9.018	92.5	-26.56	0.047	18.2	0.241	-93.8	22.83
2.4	0.838	-160.4	17.68	7.652	84.9	-26.20	0.049	13.3	0.206	-105.1	21.94
3	0.844	-171.9	15.85	6.201	75.1	-26.02	0.05	7.7	0.174	-121	20.93
3.5	0.846	-179.5	14.56	5.348	68	-25.85	0.051	3.8	0.159	-130.7	20.21
3.9	0.845	175.4	13.59	4.782	62.3	-25.85	0.051	0.7	0.161	-138.2	19.72
4	0.855	174.1	13.26	4.6	62.6	-26.02	0.05	1.8	0.153	-147	19.64
4.5	0.852	168.2	12.38	4.161	55.9	-25.85	0.051	-1.5	0.152	-150.3	19.12
5	0.856	162.7	11.52	3.766	50.4	-25.68	0.052	-3.9	0.148	-156.9	18.60
5.1	0.855	161.6	11.37	3.702	49.2	-25.68	0.052	-4.5	0.147	-157.8	18.52
5.2	0.855	160.5	11.21	3.636	48	-25.68	0.052	-5.1	0.147	-157.9	18.45
5.3	0.855	159.6	11.05	3.569	46.8	-25.51	0.053	-5.7	0.148	-158.3	18.28
5.4	0.855	158.5	10.90	3.506	45.6	-25.51	0.053	-6.3	0.15	-159.8	18.21
5.5	0.855	157.5	10.74	3.444	44.4	-25.51	0.053	-6.9	0.149	-160.9	18.13
5.6	0.855	156.5	10.60	3.387	43.1	-25.51	0.053	-7.5	0.149	-161.1	18.06
5.7	0.856	155.5	10.44	3.325	42	-25.51	0.053	-8.2	0.151	-161.5	17.98
5.8	0.856	154.5	10.28	3.266	40.7	-25.51	0.053	-9	0.153	-162.5	17.90
6	0.86	153.5	9.84	3.106	38.2	-25.68	0.052	-10.2	0.164	-163.2	17.76
7	0.869	143.2	8.49	2.657	27.9	-25.68	0.052	-14.5	0.177	-176.7	17.08
8	0.861	133.3	7.31	2.321	16.8	-25.04	0.056	-19.1	0.173	169.4	16.17
9	0.867	122.2	6.41	2.092	6.4	-25.51	0.053	-25.5	0.199	149.7	13.35
10	0.872	111.7	5.43	1.869	-6.3	-24.88	0.057	-31.5	0.238	127.7	11.71
11	0.882	101.5	4.17	1.616	-17.2	-25.68	0.052	-36	0.266	111.1	11.77
12	0.897	91.7	3.26	1.455	-28.1	-25.51	0.053	-42.6	0.32	105.5	11.55
13	0.91	83.3	2.20	1.288	-39.3	-25.85	0.051	-48	0.372	98.4	10.57
14	0.912	75.5	1.03	1.126	-49.8	-26.02	0.05	-54.3	0.417	93.7	9.88
15	0.919	68.5	-0.05	0.994	-58.8	-26.74	0.046	-57.9	0.452	90.4	8.03
16	0.904	60.2	-1.07	0.884	-68.4	-26.74	0.046	-63.5	0.485	86	6.47
17	0.891	52.5	-2.10	0.785	-77.4	-26.74	0.046	-67.5	0.515	80.2	5.84
18	0.904	44.4	-3.22	0.69	-87	-28.18	0.039	-66.8	0.544	71	13.35

Typical Noise Parameters, $V_{DS} = 3.3V$, $I_{DS} = 65 mA$

Freq GHz	F_{min} dB	Γ_{opt} Mag.	Γ_{opt} Ang.	$R_{n/50}$	NF @ 50 dB
0.9	0.85	0.1	-136.7	0.06	0.82
1.5	0.93	0.24	-178.7	0.06	0.98
1.9	1	0.27	-179.8	0.06	1.12
2	1.02	0.27	-179.9	0.06	1.15
2.4	1.07	0.3	-179.7	0.06	1.26
3	1.17	0.36	-177.5	0.06	1.38
3.5	1.24	0.4	-173.8	0.06	1.6
3.9	1.3	0.44	-171.5	0.06	1.72
4.5	1.39	0.48	-167.4	0.06	1.92
5	1.46	0.49	-164.1	0.06	2.04
5.2	1.49	0.5	-163	0.06	2.12
5.5	1.54	0.51	-160.7	0.07	2.2
5.8	1.58	0.52	-158.4	0.07	2.29
6	1.62	0.53	-156.8	0.07	2.36
7	1.78	0.55	-148.6	0.1	2.66
8	1.93	0.54	-139.4	0.16	3.02
9	2.08	0.56	-126.3	0.28	3.33
10	2.23	0.62	-115.3	0.38	3.6

Note:

- S Parameter is measured on a microstrip line made on 0.025 inch thick alumina carrier. The input reference plane is at the end of the gate lead. The output reference plane is at the end of the drain lead.

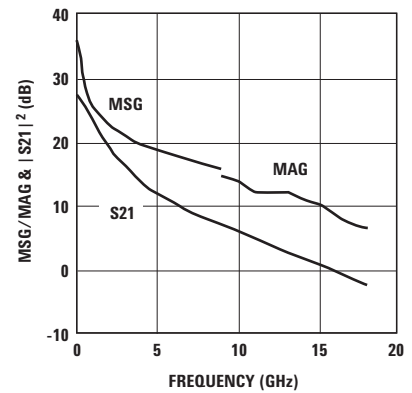

Figure 20. MSG/MAG & $|S_{21}|^2$ vs. Frequency at 3.3V, 65 mA.

MGA-425P8 Typical Scattering Parameters (at 25°C, $V_{DS} = 3.3V$, $I_{DS} = 80\text{ mA}$)

Freq. GHz	S_{11}		S_{21}			S_{12}		S_{22}		MSG/MAG	
	Mag.	Ang.	dB	Mag.	Ang.	dB	Mag.	Ang.	Mag.		Ang.
0.1	0.79	-16.3	27.73	24.356	171.1	-34.89	0.018	79.5	0.628	-8.1	36.08
0.5	0.79	-65.7	26.07	20.124	144.5	-32.40	0.024	58.1	0.55	-33.1	29.24
0.9	0.807	-100.8	24.18	16.172	124.7	-29.12	0.035	42.1	0.439	-52.5	26.65
1	0.809	-107.6	23.68	15.273	120.8	-28.87	0.036	39	0.414	-56.6	26.28
1.5	0.825	-133.2	21.36	11.698	104.7	-27.54	0.042	27.1	0.312	-73.9	24.45
1.9	0.83	-147.1	19.75	9.712	95.1	-27.13	0.044	20	0.249	-84.6	23.44
2	0.835	-150.5	19.34	9.266	92.6	-26.94	0.045	18.7	0.239	-89.1	23.14
2.4	0.839	-160.4	17.91	7.863	85	-26.74	0.046	14	0.202	-99.5	22.33
3	0.845	-171.8	16.09	6.374	75.2	-26.56	0.047	8.6	0.169	-114.5	21.32
3.5	0.847	-179.5	14.81	5.501	68.2	-26.38	0.048	4.9	0.154	-123.6	20.59
3.9	0.845	175.4	13.84	4.918	62.5	-26.38	0.048	1.8	0.156	-131.3	20.11
4	0.855	174.2	13.50	4.732	62.8	-26.38	0.048	3	0.145	-140.4	19.94
4.5	0.853	168.2	12.63	4.282	56	-26.38	0.048	-0.3	0.144	-143.4	19.50
5	0.857	162.7	11.77	3.875	50.6	-26.20	0.049	-2.5	0.14	-150	18.98
5.1	0.857	161.7	11.62	3.81	49.3	-26.02	0.05	-3.1	0.139	-150.7	18.82
5.2	0.856	160.6	11.46	3.742	48.1	-26.02	0.05	-3.6	0.139	-150.8	18.74
5.3	0.856	159.6	11.30	3.673	46.9	-26.02	0.05	-4.2	0.141	-151.3	18.66
5.4	0.856	158.6	11.15	3.609	45.7	-26.02	0.05	-4.8	0.142	-152.8	18.58
5.5	0.856	157.6	10.99	3.544	44.5	-26.02	0.05	-5.4	0.141	-153.9	18.51
5.6	0.856	156.6	10.85	3.486	43.3	-26.02	0.05	-6	0.141	-154	18.43
5.7	0.858	155.6	10.69	3.423	42.1	-26.02	0.05	-6.7	0.144	-154.5	18.35
5.8	0.857	154.6	10.53	3.361	40.8	-25.85	0.051	-7.5	0.146	-155.6	18.19
6	0.862	153.5	10.09	3.196	38.3	-26.02	0.05	-8.7	0.158	-156.7	18.06
7	0.87	143.3	8.75	2.738	28	-26.20	0.049	-12.6	0.169	-171	17.47
8	0.862	133.3	7.58	2.392	16.9	-25.35	0.054	-17.2	0.164	175	16.46
9	0.869	122.3	6.67	2.156	6.5	-25.85	0.051	-23.3	0.187	154.1	14.70
10	0.875	111.8	5.70	1.928	-6.2	-25.19	0.055	-29.2	0.224	130.8	13.77
11	0.884	101.6	4.43	1.666	-17.2	-26.02	0.05	-33.6	0.251	113.3	12.01
12	0.898	91.8	3.54	1.503	-28	-25.68	0.052	-40.3	0.305	107.5	12.08
13	0.912	83.4	2.48	1.33	-39.4	-26.02	0.05	-45.5	0.359	100.3	11.95
14	0.915	75.6	1.31	1.163	-49.9	-26.20	0.049	-51.9	0.405	95.5	11.03
15	0.921	68.6	0.22	1.026	-59	-26.94	0.045	-55.5	0.442	92.1	10.25
16	0.908	60.3	-0.79	0.913	-68.6	-26.94	0.045	-61.2	0.477	87.6	8.48
17	0.893	52.5	-1.83	0.81	-77.6	-26.94	0.045	-64.9	0.507	81.7	6.76
18	0.905	44.4	-2.96	0.711	-87.2	-28.18	0.039	-63.9	0.537	72.4	6.09

Typical Noise Parameters, $V_{DS} = 3.3V$, $I_{DS} = 80\text{ mA}$

Freq GHz	F_{min} dB	Γ_{opt} Mag.	Γ_{opt} Ang.	$R_{n/50}$	NF @ 50 dB
0.9	0.86	0.1	-134.9	0.06	0.84
1.5	0.95	0.25	-173.6	0.06	1.03
1.9	1.03	0.27	-177.4	0.06	1.16
2	1.05	0.28	-177.7	0.06	1.19
2.4	1.1	0.31	-178.9	0.06	1.32
3	1.19	0.37	-177.4	0.05	1.48
3.5	1.28	0.42	-174	0.05	1.68
3.9	1.35	0.44	-170.6	0.06	1.81
4.5	1.46	0.48	-167	0.06	2.01
5	1.53	0.5	-163.6	0.06	2.15
5.2	1.56	0.5	-161.8	0.07	2.17
5.5	1.62	0.52	-159.4	0.07	2.23
5.8	1.66	0.53	-157.8	0.07	2.44
6	1.7	0.54	-156.1	0.07	2.52
7	1.86	0.55	-147.8	0.12	2.8
8	2.03	0.56	-138.6	0.18	3.22
9	2.2	0.57	-125.5	0.31	3.52
10	2.37	0.63	-114.8	0.42	3.95

Note:

- S Parameter is measured on a microstrip line made on 0.025 inch thick alumina carrier. The input reference plane is at the end of the gate lead. The output reference plane is at the end of the drain lead.

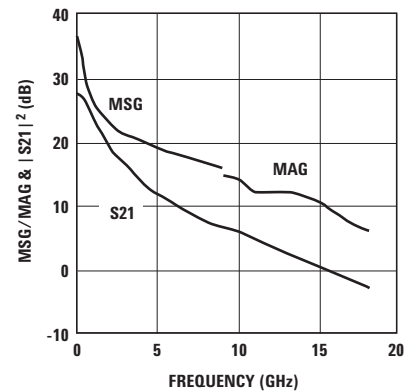

Figure 21. MSG/MAG & $|S_{21}|^2$ vs. Frequency at 3.3V, 80 mA.

MGA-425P8 Typical Scattering Parameters (at 25°C, $V_{DS} = 4V$, $I_{DS} = 60\text{ mA}$)

Freq. GHz	S_{11}		S_{21}			S_{12}		S_{22}		MSG/MAG	
	Mag.	Ang.	dB	Mag.	Ang.	dB	Mag.	Ang.	Mag.		Ang.
0.1	0.797	-16.4	27.38	23.399	171	-33.98	0.02	79.2	0.66	-7.8	35.91
0.5	0.793	-65.7	25.70	19.285	144.4	-32.40	0.024	58	0.578	-31.2	29.05
0.9	0.809	-100.8	23.80	15.495	124.6	-29.12	0.035	41.9	0.463	-49.1	26.46
1	0.81	-107.5	23.31	14.637	120.7	-28.64	0.037	38.7	0.437	-52.8	25.97
1.5	0.826	-133.2	21.00	11.22	104.6	-27.33	0.043	26.7	0.331	-68.1	24.17
1.9	0.83	-147	19.39	9.32	95	-26.94	0.045	19.6	0.266	-76.9	23.16
2	0.836	-150.5	18.98	8.891	92.4	-26.74	0.046	18.4	0.254	-80.9	22.86
2.4	0.839	-160.4	17.56	7.551	84.7	-26.56	0.047	13.5	0.215	-89.5	22.06
3	0.844	-171.8	15.74	6.125	74.9	-26.38	0.048	8	0.177	-102.1	21.06
3.5	0.847	-179.5	14.47	5.288	67.7	-26.20	0.049	4.3	0.16	-109.9	20.33
3.9	0.845	175.4	13.49	4.726	61.9	-26.20	0.049	1	0.16	-117.9	19.84
4	0.856	174.2	13.15	4.547	62.4	-26.20	0.049	2.3	0.142	-126.1	19.68
4.5	0.854	168.1	12.29	4.116	55.4	-26.20	0.049	-1	0.144	-128.7	19.24
5	0.856	162.7	11.42	3.726	49.9	-26.02	0.05	-3.3	0.139	-134.7	18.72
5.1	0.856	161.6	11.28	3.664	48.6	-26.02	0.05	-3.9	0.138	-135.2	18.65
5.2	0.856	160.6	11.12	3.598	47.4	-26.02	0.05	-4.5	0.138	-135.4	18.57
5.3	0.856	159.6	10.96	3.533	46.2	-25.85	0.051	-5	0.141	-136.1	18.41
5.4	0.856	158.5	10.81	3.47	45	-25.85	0.051	-5.6	0.142	-137.7	18.33
5.5	0.855	157.5	10.65	3.409	43.8	-25.85	0.051	-6.2	0.141	-138.7	18.25
5.6	0.855	156.5	10.51	3.352	42.5	-25.85	0.051	-6.9	0.142	-138.9	18.18
5.7	0.857	155.5	10.35	3.291	41.3	-25.85	0.051	-7.5	0.145	-139.7	18.10
5.8	0.857	154.5	10.19	3.231	40	-25.85	0.051	-8.3	0.147	-141	18.02
6	0.861	153.4	9.75	3.072	37.5	-26.02	0.05	-9.4	0.16	-143.5	17.88
7	0.87	143.3	8.42	2.635	27	-26.02	0.05	-13.4	0.167	-158.6	17.22
8	0.862	133.3	7.25	2.305	15.8	-25.35	0.054	-17.9	0.16	-172.5	16.30
9	0.869	122.3	6.36	2.079	5.1	-25.85	0.051	-24.1	0.174	164.9	13.27
10	0.873	111.8	5.38	1.858	-7.7	-25.19	0.055	-29.8	0.204	139.2	11.66
11	0.883	101.5	4.13	1.608	-18.8	-26.02	0.05	-34.2	0.228	119.6	11.72
12	0.897	91.8	3.23	1.451	-29.8	-25.68	0.052	-40.7	0.284	113	11.59
13	0.911	83.3	2.18	1.285	-41.4	-26.02	0.05	-45.9	0.341	105.1	10.70
14	0.914	75.5	1.01	1.123	-52.2	-26.20	0.049	-52.4	0.392	99.7	9.93
15	0.92	68.6	-0.10	0.989	-61.5	-26.94	0.045	-56	0.433	95.9	8.07
16	0.906	60.2	-1.13	0.878	-71.3	-26.94	0.045	-61.6	0.469	91	6.48
17	0.893	52.4	-2.17	0.779	-80.5	-26.94	0.045	-65.5	0.502	84.9	5.78
18	0.904	44.3	-3.30	0.684	-90.4	-28.18	0.039	-64.6	0.533	75.3	13.27

Typical Noise Parameters, $V_{DS} = 4V$, $I_{DS} = 60\text{ mA}$

Freq GHz	F_{min} dB	Γ_{opt} Mag.	Γ_{opt} Ang.	$R_{n/50}$	NF @ 50 dB
0.9	0.86	0.1	-133.6	0.06	0.83
1.5	0.94	0.23	-175.5	0.06	1.01
1.9	1	0.26	-178.3	0.06	1.12
2	1.03	0.27	-179.6	0.06	1.15
2.4	1.08	0.3	-178.7	0.06	1.27
3	1.17	0.36	-178.1	0.06	1.41
3.5	1.25	0.4	-173.8	0.06	1.59
3.9	1.3	0.43	-171.7	0.06	1.7
4.5	1.39	0.47	-167	0.06	1.9
5	1.47	0.48	-164.8	0.06	2.08
5.2	1.5	0.49	-163	0.06	2.1
5.5	1.53	0.5	-160.2	0.07	2.18
5.8	1.6	0.51	-158.6	0.07	2.27
6	1.62	0.53	-157.1	0.07	2.33
7	1.76	0.54	-149.2	0.1	2.63
8	1.93	0.53	-139.8	0.16	2.94
9	2.08	0.55	-126.4	0.28	3.25
10	2.22	0.61	-115.6	0.37	3.61

Note:

- S Parameter is measured on a microstrip line made on 0.025 inch thick alumina carrier. The input reference plane is at the end of the gate lead. The output reference plane is at the end of the drain lead.

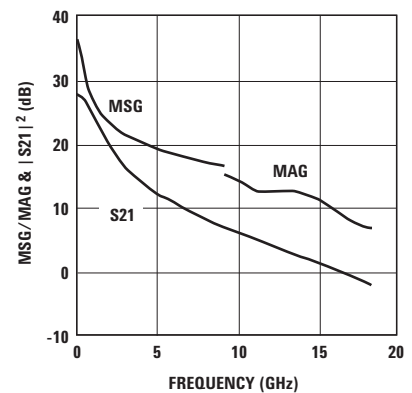

Figure 22. MSG/MAG & $|S_{21}|^2$ vs. Frequency at 4V, 60 mA.

MGA-425P8 Typical Scattering Parameters (at 25°C, $V_{DS} = 4V$, $I_{DS} = 65\text{ mA}$)

Freq. GHz	S_{11}		S_{21}			S_{12}			S_{22}		MSG/MAG
	Mag.	Ang.	dB	Mag.	Ang.	dB	Mag.	Ang.	Mag.	Ang.	
0.1	0.796	-16.5	27.47	23.632	171	-33.98	0.02	79.6	0.657	-7.8	35.95
0.5	0.793	-66	25.79	19.472	144.3	-32.40	0.024	57.9	0.575	-31.2	29.09
0.9	0.809	-101.1	23.88	15.63	124.5	-29.12	0.035	41.8	0.46	-49	26.50
1	0.811	-107.8	23.38	14.76	120.6	-28.64	0.037	38.7	0.434	-52.7	26.01
1.5	0.826	-133.4	21.06	11.304	104.5	-27.33	0.043	26.7	0.329	-67.8	24.20
1.9	0.832	-147.3	19.45	9.386	94.9	-26.94	0.045	19.6	0.264	-76.5	23.19
2	0.836	-150.6	19.04	8.956	92.3	-26.94	0.045	18.3	0.252	-80.4	22.99
2.4	0.839	-160.6	17.62	7.605	84.7	-26.74	0.046	13.6	0.213	-88.9	22.18
3	0.846	-172	15.80	6.169	74.8	-26.56	0.047	8.1	0.176	-101.5	21.18
3.5	0.848	-179.6	14.53	5.326	67.7	-26.38	0.048	4.4	0.159	-109.3	20.45
3.9	0.846	175.3	13.55	4.759	61.9	-26.38	0.048	1.2	0.159	-117.3	19.96
4	0.856	174	13.21	4.578	62.3	-26.38	0.048	2.5	0.141	-125.6	19.79
4.5	0.854	168	12.35	4.144	55.4	-26.38	0.048	-0.8	0.142	-128	19.36
5	0.857	162.6	11.49	3.752	49.9	-26.20	0.049	-2.9	0.137	-133.9	18.84
5.1	0.857	161.6	11.34	3.688	48.7	-26.02	0.05	-3.5	0.136	-134.4	18.68
5.2	0.857	160.5	11.18	3.623	47.5	-26.02	0.05	-4.1	0.137	-134.5	18.60
5.3	0.857	159.5	11.02	3.556	46.2	-26.02	0.05	-4.7	0.139	-135.2	18.52
5.4	0.857	158.5	10.87	3.494	45	-26.02	0.05	-5.2	0.141	-136.9	18.44
5.5	0.856	157.5	10.71	3.431	43.8	-26.02	0.05	-5.8	0.14	-137.8	18.36
5.6	0.856	156.4	10.57	3.375	42.5	-26.02	0.05	-6.5	0.141	-138	18.29
5.7	0.858	155.4	10.40	3.312	41.3	-26.02	0.05	-7.1	0.144	-138.8	18.21
5.8	0.857	154.5	10.25	3.253	40	-26.02	0.05	-7.8	0.146	-140.1	18.13
6	0.862	153.4	9.81	3.093	37.5	-26.20	0.049	-9	0.159	-142.7	18.00
7	0.87	143.2	8.48	2.654	27.1	-26.20	0.049	-12.9	0.166	-157.9	17.34
8	0.863	133.2	7.31	2.321	15.8	-25.51	0.053	-17.4	0.159	-171.8	16.41
9	0.869	122.2	6.42	2.093	5.2	-25.85	0.051	-23.6	0.173	165.5	14.43
10	0.874	111.7	5.45	1.872	-7.6	-25.19	0.055	-29.2	0.203	139.6	13.43
11	0.884	101.5	4.18	1.618	-18.8	-26.20	0.049	-33.5	0.227	119.9	11.73
12	0.898	91.8	3.29	1.461	-29.7	-25.85	0.051	-40	0.282	113.3	11.79
13	0.912	83.3	2.24	1.294	-41.3	-26.02	0.05	-45.3	0.339	105.3	11.74
14	0.915	75.5	1.08	1.132	-52.1	-26.20	0.049	-51.6	0.39	100	10.84
15	0.921	68.6	-0.03	0.997	-61.3	-26.94	0.045	-55.2	0.431	96.1	10.05
16	0.906	60.2	-1.07	0.884	-71.2	-26.94	0.045	-60.9	0.468	91.3	8.12
17	0.894	52.4	-2.09	0.786	-80.3	-26.94	0.045	-64.8	0.501	85.2	6.59
18	0.905	44.4	-3.25	0.688	-90.2	-28.18	0.039	-63.8	0.532	75.5	5.86

Typical Noise Parameters, $V_{DS} = 4V$, $I_{DS} = 65\text{ mA}$

Freq GHz	F_{min} dB	Γ_{opt} Mag.	Γ_{opt} Ang.	$R_{n/50}$	NF @ 50 dB
0.9	0.87	0.1	-136.8	0.06	0.85
1.5	0.97	0.23	-173.5	0.06	1.01
1.9	1.03	0.26	-176.5	0.06	1.14
2	1.05	0.27	-177.5	0.07	1.16
2.4	1.1	0.3	-179.7	0.07	1.27
3	1.19	0.36	-177.7	0.06	1.41
3.5	1.27	0.39	-173.7	0.06	1.61
3.9	1.35	0.43	-171.2	0.06	1.72
4.5	1.45	0.47	-167.3	0.06	1.92
5	1.5	0.48	-164	0.07	2.06
5.2	1.52	0.49	-162.4	0.07	2.12
5.5	1.57	0.5	-159.9	0.07	2.23
5.8	1.63	0.52	-158.2	0.07	2.31
6	1.66	0.53	-156.4	0.07	2.37
7	1.81	0.54	-148.6	0.11	2.68
8	2	0.54	-139.3	0.17	3.04
9	2.13	0.56	-125.4	0.29	3.29
10	2.28	0.62	-115.1	0.39	3.59

Note:

- S Parameter is measured on a microstrip line made on 0.025 inch thick alumina carrier. The input reference plane is at the end of the gate lead. The output reference plane is at the end of the drain lead.

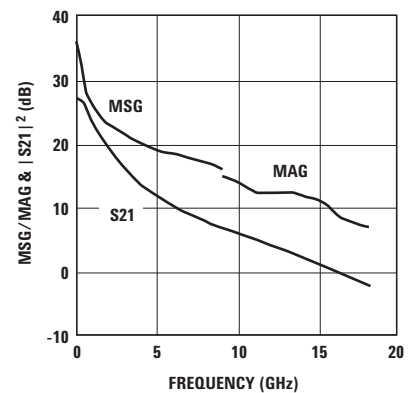

Figure 23. MSG/MAG & $|S_{21}|^2$ vs. Frequency at 4V, 65 mA.

Device Models

Refer to Agilent's Web Site
www.agilent.com/view/rf

Ordering Information

Part Number	No. of Devices	Container
MGA-425P8-TR1	3000	7" Reel
MGA-425P8-TR2	10000	13" Reel
MGA-425P8-BLK	100	antistatic bag

2x2 LPCC (JEDEC DFP-N) Package Dimensions

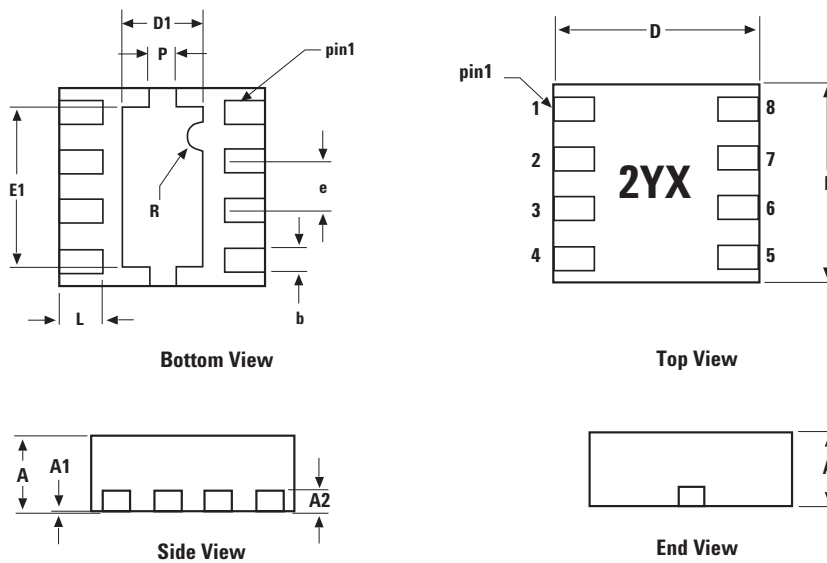

SYMBOL	DIMENSIONS		
	MIN.	NOM.	MAX.
A	0.70	0.75	0.80
A1	0	0.02	0.05
A2		0.203 REF	
b	0.225	0.25	0.275
D	1.9	2.0	2.1
D1	0.65	0.80	0.95
E	1.9	2.0	2.1
E1	1.45	1.6	1.75
e		0.50 BSC	

DIMENSIONS ARE IN MILLIMETERS

PCB Land Pattern and Stencil Design

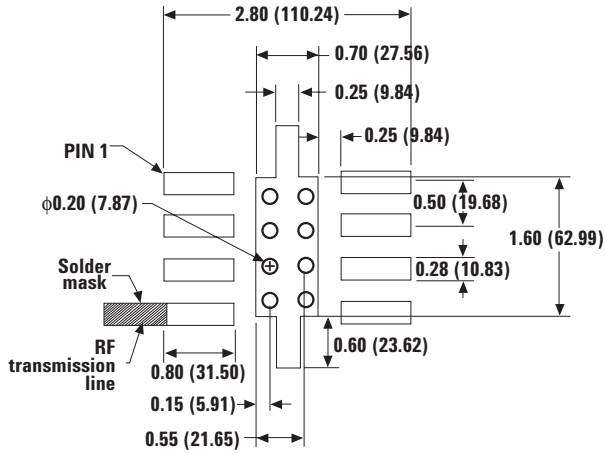

PCB Land Pattern (top view)

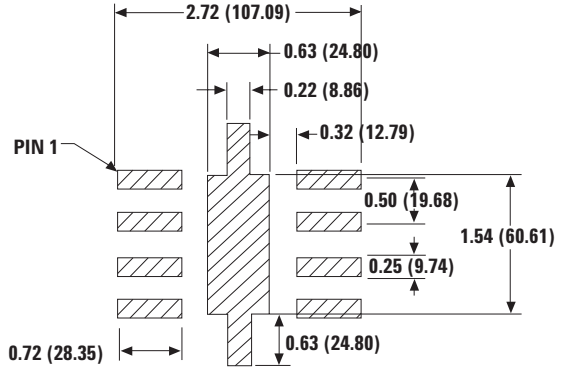

Stencil Layout (top view)

Notes: Typical stencil thickness is 5 mils.
Measurements are in millimeters (mils).

Device Orientation

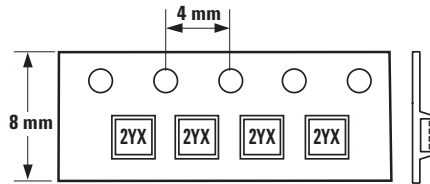
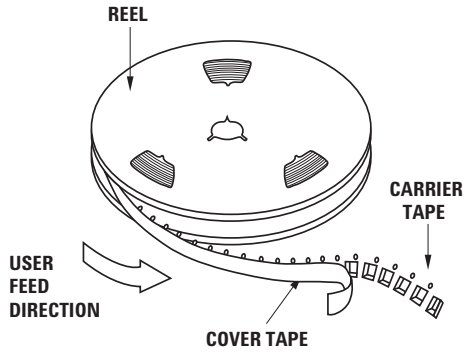

Tape Dimensions

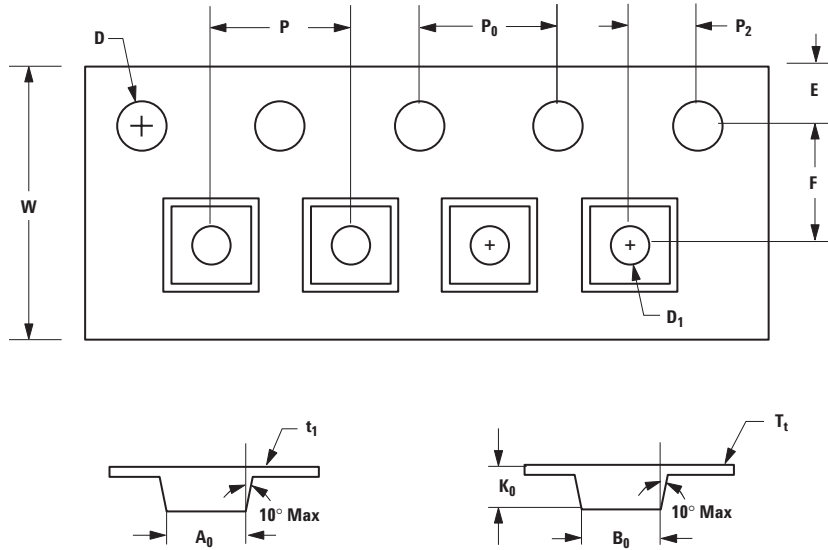

DESCRIPTION		SYMBOL	SIZE (mm)	SIZE (inches)
CARRIER TAPE	LENGTH	A ₀	2.30 ± 0.05	0.091 ± 0.004
	WIDTH	B ₀	2.30 ± 0.05	0.091 ± 0.004
	DEPTH	K ₀	1.00 ± 0.05	0.039 ± 0.002
	PITCH	P	4.00 ± 0.10	0.157 ± 0.004
	BOTTOM HOLE DIAMETER	D ₁	1.00 + 0.25	0.039 + 0.002
PERFORATION	DIAMETER	D	1.50 ± 0.10	0.060 ± 0.004
	PITCH	P ₀	4.00 ± 0.10	0.157 ± 0.004
	POSITION	E	1.75 ± 0.10	0.069 ± 0.004
COVER TAPE	WIDTH	W	8.00 + 0.30 8.00 - 0.10	0.315 ± 0.012 0.315 ± 0.004
	THICKNESS	t ₁	0.254 ± 0.02	0.010 ± 0.0008
DISTANCE	CAVITY TO PERFORATION (WIDTH DIRECTION)	F	3.50 ± 0.05	0.138 ± 0.002
	CAVITY TO PERFORATION (LENGTH DIRECTION)	P ₂	2.00 ± 0.05	0.079 ± 0.002

www.agilent.com/semiconductors

For product information and a complete list of distributors, please go to our web site.

For technical assistance call:

Americas/Canada: +1 (800) 235-0312 or (916) 788-6763

Europe: +49 (0) 6441 92460

China: 10800 650 0017

Hong Kong: (65) 6756 2394

India, Australia, New Zealand: (65) 6755 1939

Japan: (+81 3) 3335-8152(Domestic/International), or 0120-61-1280(Domestic Only)

Korea: (65) 6755 1989

Singapore, Malaysia, Vietnam, Thailand, Philippines, Indonesia: (65) 6755 2044

Taiwan: (65) 6755 1843

Data subject to change.

Copyright © 2004 Agilent Technologies, Inc.

July 19, 2004



5989-1068EN



Agilent Technologies

Looking for pricing, stock, or lifecycle information?

Click below to explore more details on WIN SOURCE:

-  [View MGA-425P8-BLK on WIN SOURCE](#)
-  [Broadcom Limited Information](#)

Optimize Your Supply Chain with WIN SOURCE Solutions

-  Global Sourcing Solution
-  Obsolete Management
-  Cost Control Management
-  Shortage Management
-  Alternative Solution
-  Excess Inventory Management