

Tiny Low-Noise Amplifiers for HSPA/LTE

General Description

The MAX2666/MAX2668 are a family of low-noise amplifiers (LNAs) intended for use in HSPA mobile handsets. The LNAs provide three programmable gain states, delivering superior optimization for linearity and sensitivity versus traditional two-gain-state LNAs.

The MAX2666 is optimized for use over the 2100MHz to 2200MHz frequency range (bands 1, 4, and 10) and offers a typical maximum gain of 14.5dB.

The MAX2668 is optimized for use over the 850MHz to 1000MHz frequency range (bands 5, 6, and 8) and provides a typical maximum gain of 17dB.

Each device is available in a tiny 1mm x 1.5mm, 6-pin ultra-thin LGA package.

Applications

HSPA/LTE Front-End Modules
HSPA/LTE Preamplification

Features

- ◆ **Small Footprint: 1mm x 1.5mm Package**
- ◆ **Thin Profile: 0.55mm**
- ◆ **Low Noise Figure**
1dB for MAX2668
1.1dB for MAX2666
- ◆ **Three Gain States for Optimum Blocker Handling**
- ◆ **3.8mA Low Supply Current**
- ◆ **Low Bill of Materials**

Ordering Information

PART	TEMP RANGE	PIN-PACKAGE
MAX2666EYT+	-40°C to +85°C	6 Ultra-Thin LGA
MAX2668EYT+	-40°C to +85°C	6 Ultra-Thin LGA

+ Denotes a lead(Pb)-free/RoHS-compliant package.

Typical Operating Circuit

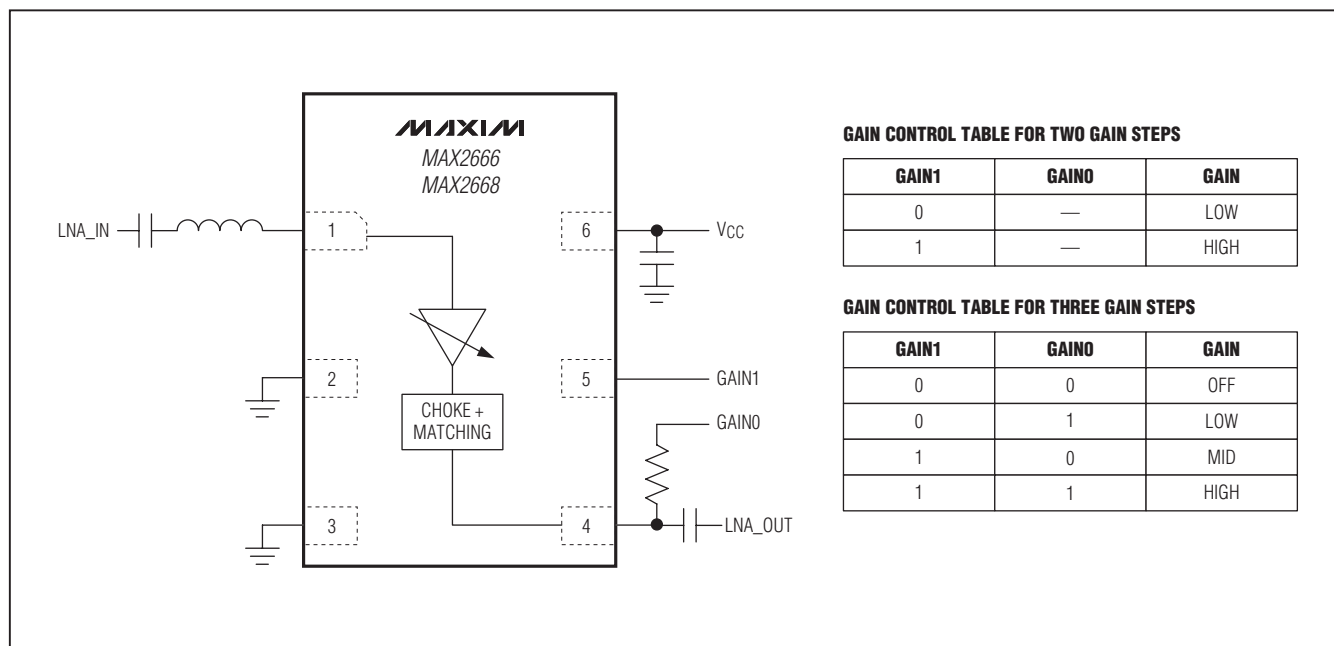

Tiny Low-Noise Amplifiers for HSPA/LTE

ABSOLUTE MAXIMUM RATINGS

V_{CC} to GND.....-0.3V to +3.6V
 Other Pins to GND -0.3V to (V_{CC} + 0.3V)
 Maximum Input Power..... +10dBm
 Continuous Power Dissipation (T_A = +70°C)
 Ultra-Thin LGA (derate 2.1mW/°C above +70°C)..... 167mW

Operating Temperature Range..... -40°C to +85°C
 Junction Temperature+150°C
 Storage Temperature Range.....-65°C to +160°C
 Lead Temperature (soldering, 10s)+260°C
 Soldering Temperature (reflow)+260°C

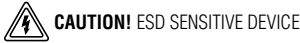

Stresses beyond those listed under "Absolute Maximum Ratings" may cause permanent damage to the device. These are stress ratings only, and functional operation of the device at these or any other conditions beyond those indicated in the operational sections of the specifications is not implied. Exposure to absolute maximum rating conditions for extended periods may affect device reliability.

DC ELECTRICAL CHARACTERISTICS

(Typical Operating Circuit, MAX2666/MAX2668 Evaluation Kit, GAIN1 = High, GAIN0 = High-Z, V_{CC} = 2.7V to 3.3V, no RF signal applied, T_A = -40°C to +85°C. Typical values are at V_{CC} = 2.85V, T_A = +25°C, unless otherwise noted.) (Note 1)

PARAMETER	CONDITIONS	MIN	TYP	MAX	UNITS
Supply Voltage		2.7	2.85	3.3	V
Supply Current, High Gain	GAIN_ = 11		3.8		mA
Supply Current, Mid Gain	GAIN_ = 10		3.8		mA
Supply Current, Low Gain	GAIN_ = 01			100	μA
Shutdown Current	GAIN_ = 00			100	μA
Logic-High (V _{IH})		1.2			V
Logic-Low (V _{IL})				0.5	V

AC ELECTRICAL CHARACTERISTICS

(MAX2666/MAX2668 Evaluation Kit, input matching network according to Table 1 (input matching network), GAIN1 = High, GAIN0 = High-Z, V_{CC} = 2.85V, T_A = +25°C, unless otherwise noted.)

PARAMETER	CONDITIONS	MIN	TYP	MAX	UNITS
MAX2666					
Frequency Range	Bands 1, 4, 10	2110	2140	2170	MHz
Gain	HG mode	10	14.5	17.5	dB
	MG mode, GAIN_ = 10	0	5	8.5	
	LG mode, GAIN_ = 01	-15.5	-12	-9	
Noise Figure	HG mode		1.1		dB
	MG mode, GAIN_ = 10		3		
	LG mode, GAIN_ = 01		12		
Input 3rd-Order Intercept (Note 2)	HG mode		-2		dBm
	MG mode, GAIN_ = 10		4		
	LG mode, GAIN_ = 01		> 20		
Phase Shift with Gain Step			15		Degrees

Tiny Low-Noise Amplifiers for HSPA/LTE

MAX2666/MAX2668

AC ELECTRICAL CHARACTERISTICS (continued)

(MAX2666/MAX2668 Evaluation Kit, input matching network according to Table 1 (input matching network), GAIN1 = High, GAIN0 = High-Z, V_{CC} = 2.85V, T_A = +25°C, unless otherwise noted.)

PARAMETER	CONDITIONS	MIN	TYP	MAX	UNITS
MAX2668 (BAND 8)					
Frequency Range	Band 8	925	942	960	MHz
Gain	HG mode	13.5	17	21	dB
	MG mode, GAIN_ = 10	0	5	8	
	LG mode, GAIN_ = 01	-19	-16	-13	
Noise Figure	HG mode		1		dB
	MG mode, GAIN_ = 10		5		
	LG mode, GAIN_ = 01		16		
Input 3rd-Order Intercept (Note 2)	HG mode		-4		dBm
	MG mode, GAIN_ = 10		2		
	LG mode, GAIN_ = 01		> 18		
Phase Shift with Gain Step			15		Degrees
MAX2668 (BAND 5, BAND 6)					
Frequency Range	Bands 5 and 6	869	881.52	894	MHz
Gain	HG mode	13.5	17	21	dB
	MG mode, GAIN_ = 10	0	5	8	
	LG mode, GAIN_ = 01	-19	-16	-13	
Noise Figure	HG mode		1		dB
	MG mode, GAIN_ = 10		5		
	LG mode, GAIN_ = 01		16		
Input 3rd-Order Intercept (Note 2)	HG mode		-5		dBm
	MG mode, GAIN_ = 10		2		
	LG mode, GAIN_ = 01		> 18		
Phase Shift with Gain Step			15		Degrees

Note 1: Guaranteed by test at T_A = +25°C; guaranteed by design and characterization at T_A = -40°C and T_A = +85°C.

Note 2: -25dBm/tone at high gain, -15dBm/tone at mid gain, -15dBm/tone at low gain. Tone separation less than 5MHz.

Tiny Low-Noise Amplifiers for HSPA/LTE

Typical Operating Characteristics

(MAX2666/MAX2668 Evaluation Kit. Typical values are at $V_{CC} = 2.85V$, $T_A = +25^\circ C$, unless otherwise noted.)

MAX2666 GAIN vs. FREQUENCY AND TEMPERATURE HIGH-GAIN MODE

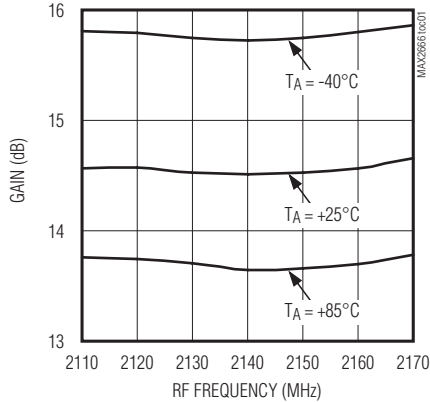

MAX2666 GAIN vs. FREQUENCY AND TEMPERATURE MID-GAIN MODE

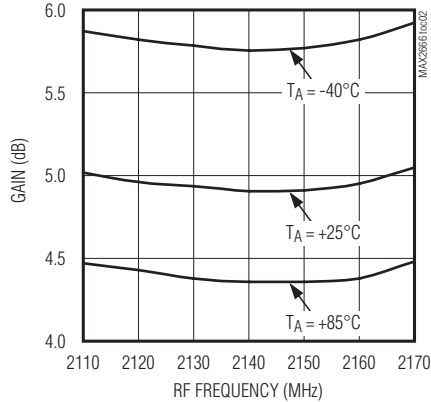

MAX2666 GAIN vs. FREQUENCY AND TEMPERATURE LOW-GAIN MODE

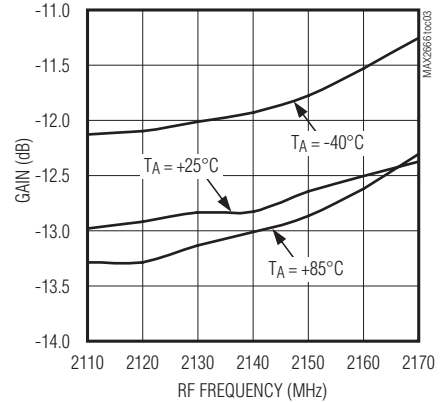

MAX2666 NOISE FIGURE vs. FREQUENCY AND TEMPERATURE HIGH-GAIN MODE

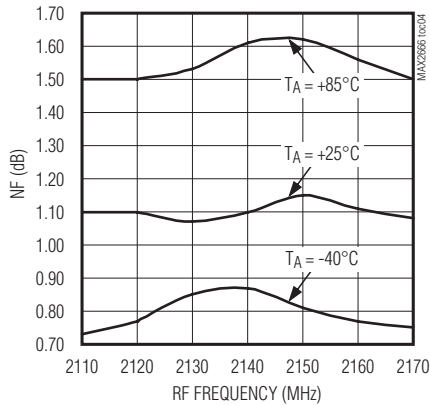

MAX2666 IIP3 vs. SUPPLY VOLTAGE AND TEMPERATURE MID BAND 10; 5MHz TONE'S SEPARATION

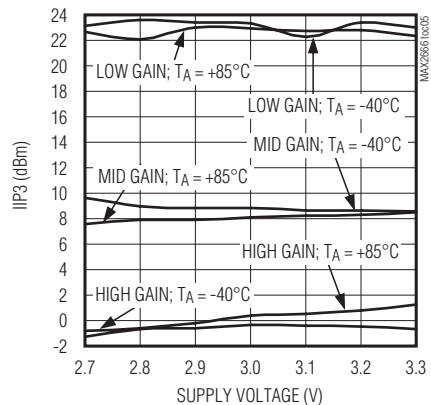

MAX2666 S11 HIGH-GAIN MODE

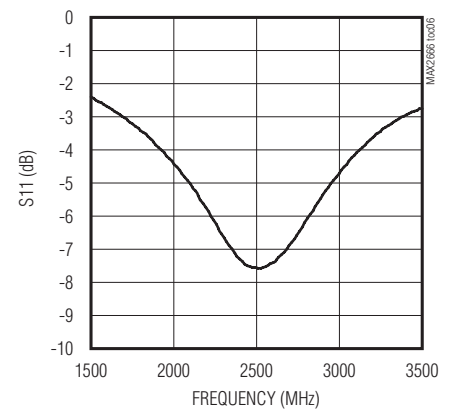

MAX2666 S22 HIGH-GAIN MODE

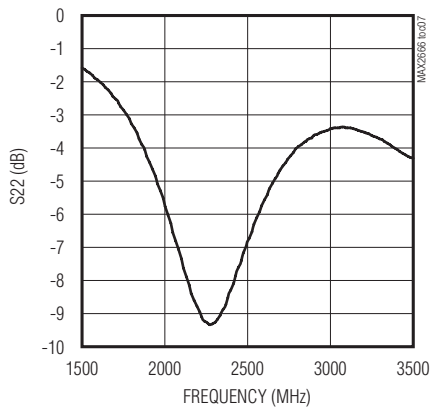

MAX2666 S21 HIGH-GAIN MODE

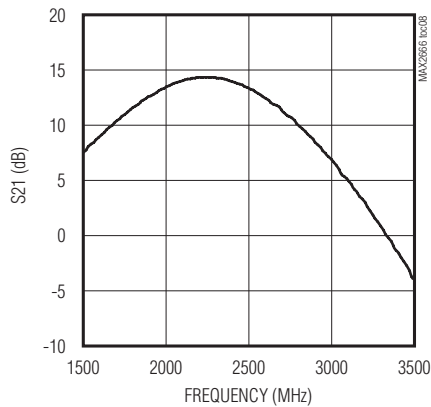

MAX2666 S12 HIGH-GAIN MODE

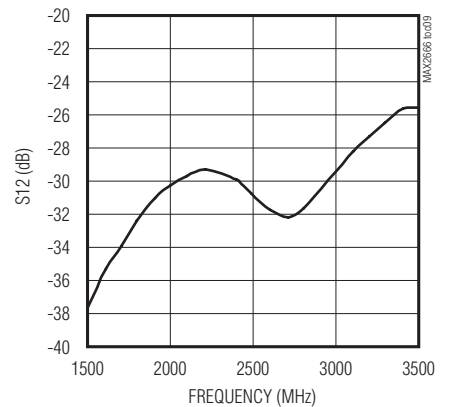

Tiny Low-Noise Amplifiers for HSPA/LTE

Typical Operating Characteristics (continued)

(MAX2666/MAX2668 Evaluation Kit. Typical values are at $V_{CC} = 2.85V$, $T_A = +25^\circ C$, unless otherwise noted.)

MAX2666/MAX2668

MAX2668 GAIN vs. FREQUENCY AND TEMPERATURE HIGH-GAIN MODE

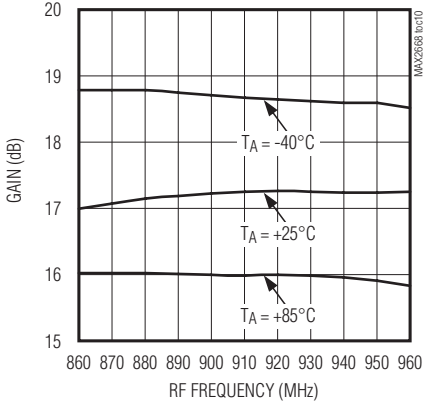

MAX2668 GAIN vs. FREQUENCY AND TEMPERATURE MID-GAIN MODE

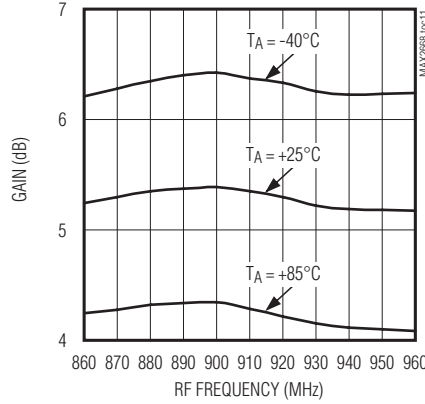

MAX2668 GAIN vs. FREQUENCY AND TEMPERATURE LOW-GAIN MODE

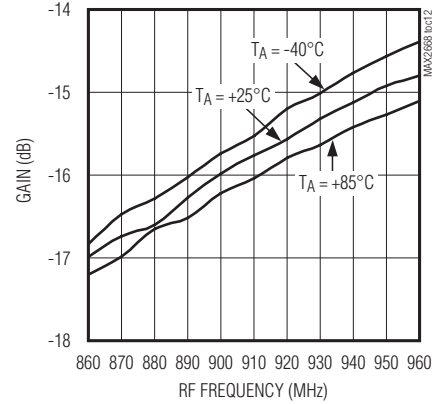

MAX2668 NOISE FIGURE vs. FREQUENCY AND TEMPERATURE HIGH-GAIN MODE

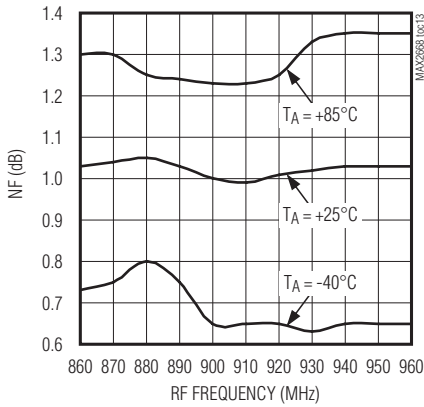

MAX2668 IIP3 vs. SUPPLY VOLTAGE AND TEMPERATURE MID BAND 8; 5MHz TONE'S SEPARATION

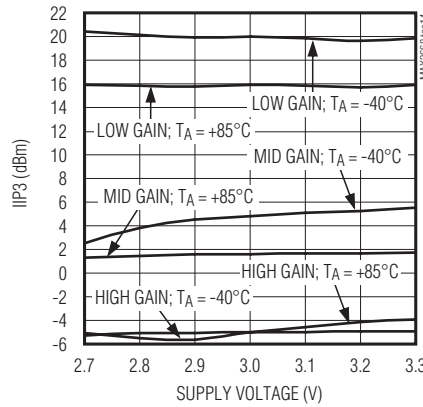

MAX2668 S11 HIGH-GAIN MODE

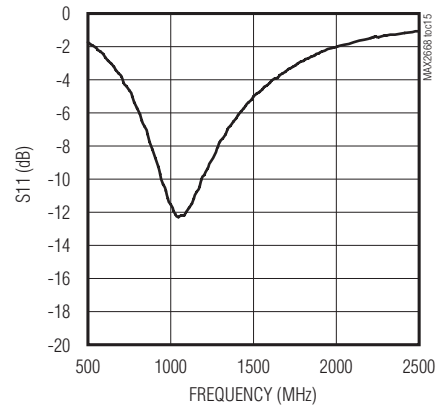

MAX2668 S22 HIGH-GAIN MODE

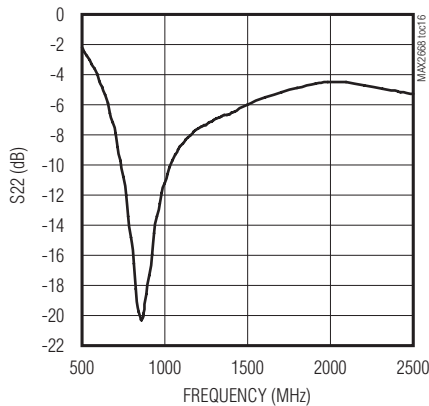

MAX2668 S21 HIGH-GAIN MODE

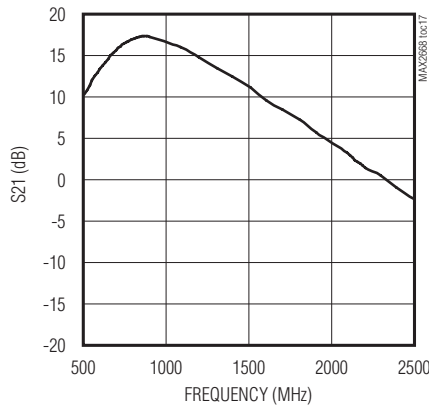

MAX2668 S12 HIGH-GAIN MODE

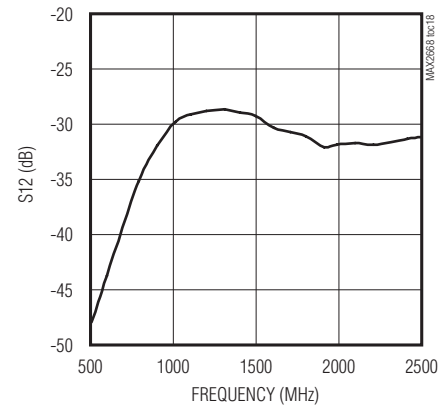

Tiny Low-Noise Amplifiers for HSPA/LTE

Pin Configuration

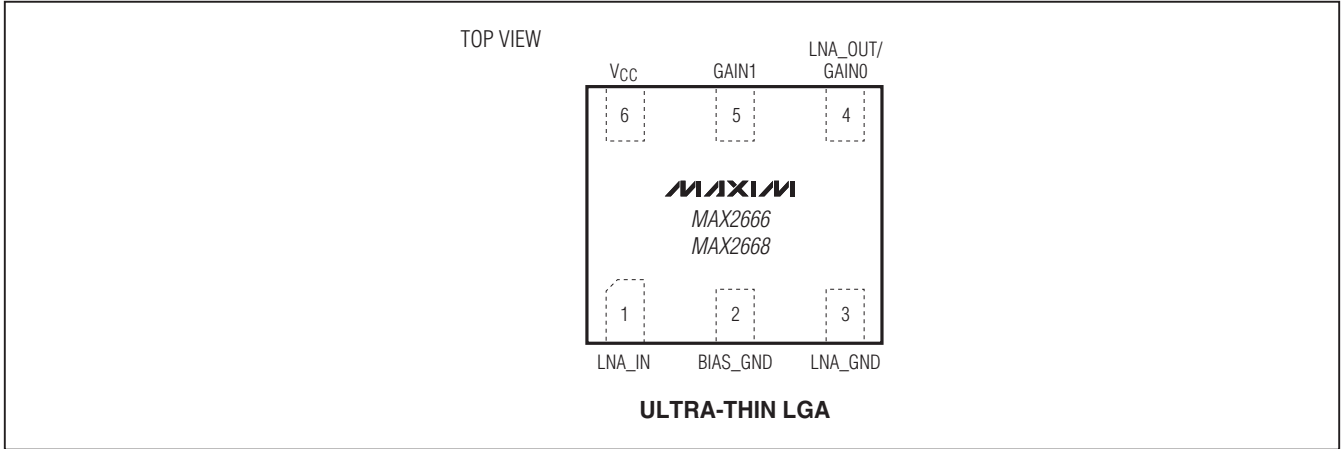

Pin Description

PIN	NAME	FUNCTION
1	LNA_IN	RF Input. Match according to band in Table 1.
2	BIAS_GND	DC and Bias Ground
3	LNA_GND	RF Ground
4	LNA_OUT/GAIN0	RF Output and Gain Control. Internally match to 50Ω. Couple gain logic with a 20kΩ resistor. When DC is open-circuit, pin self-biases to logic-high.
5	GAIN1	Gain Control. Together with GAIN0, selects gain mode. Must be connected to logic-high or logic-low.
6	VCC	Supply Voltage. Bypass with a 1000pF capacitor to ground.

Tiny Low-Noise Amplifiers for HSPA/LTE

Detailed Description

The MAX2666/MAX2668 are low-power LNAs designed for 3G mobile applications. The devices feature low noise, high linearity, and three gain steps in a tiny plastic package.

Input and Output Matching

The devices require one matching inductor at the input port in series with a DC-blocking capacitor to achieve optimal performance in NF, gain, IIP3, and phase shift. Table 1 presents the recommended input-matching network values. The output port is internally matched to 50Ω, eliminating the need for external matching components. At the output port, an external DC-blocking capacitor should be used to isolate the control function of the output pin.

DC Decoupling and Layout

A properly designed PCB is essential to any RF micro-wave circuit. Use controlled-impedance lines on all high-frequency inputs and outputs. Bypass V_{CC} with a decoupling capacitor located close to the device.

For long V_{CC} lines, it might be necessary to add decoupling capacitors. Locate these additional capacitors further away from the device package. Proper grounding

of the GND pins is essential. If the PCB uses a top-side RF ground, connect it directly to the GND pins. For a board where the ground is not on the component layer, connect the GND pins to the board with multiple vias close to the package.

Gain Control

The devices' LNA_OUT/GAIN0 pin is also used as a control pin for the LNA gain modes according to the gain control table. GAIN0 logic level is set through an external 20kΩ resistor. An external DC-blocking capacitor should be used to isolate the control function of this dual-purpose pin (see the *Typical Operating Circuit*). The GAIN1 pin must be set to either logic-high or logic-low.

Refer to www.maxim-ic.com for the MAX2666/MAX2668 Evaluation Kit schematic, Gerber data, PADS layout file, and BOM information.

Table 1. Matching Component Values in Different Bands

BAND	SERIES C (nF)	SERIES L (nH)
1, 4, 10	10	3.9
5, 6	10	12
8	10	12

Detailed Application Circuit in EV Kit

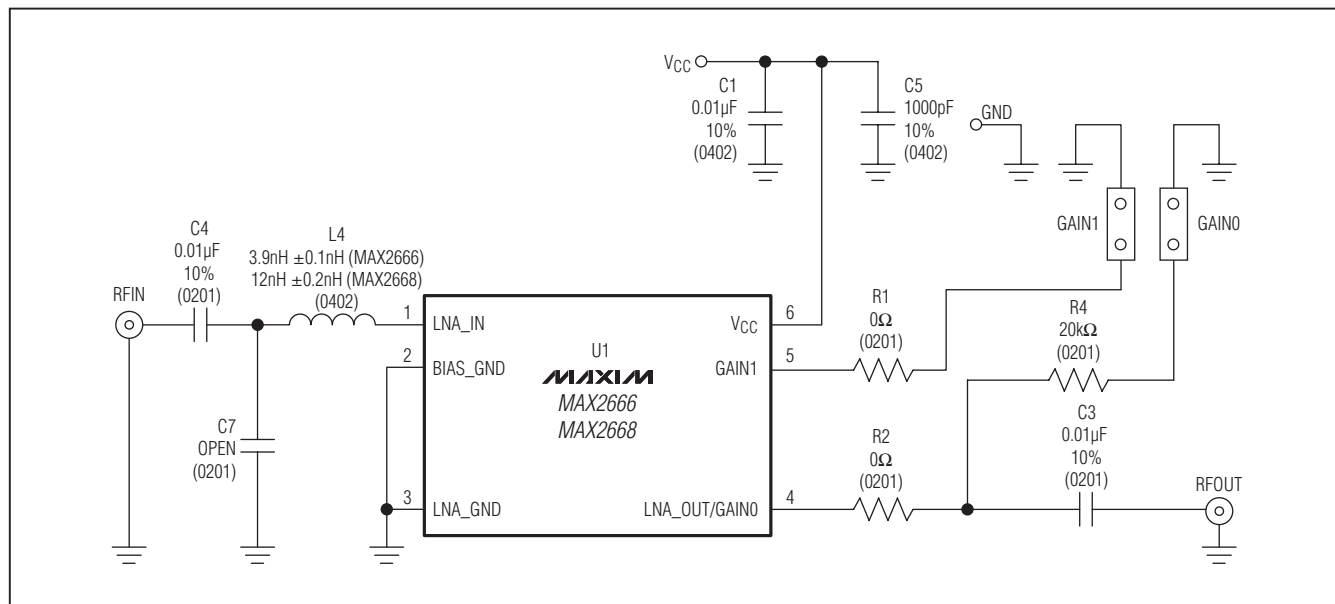

Tiny Low-Noise Amplifiers for HSPA/LTE

Chip Information

PROCESS: SiGe BiCMOS

Package Information

For the latest package outline information and land patterns, go to www.maxim-ic.com/packages. Note that a "+", "#", or "-" in the package code indicates RoHS status only. Package drawings may show a different suffix character, but the drawing pertains to the package regardless of RoHS status.

PACKAGE TYPE	PACKAGE CODE	OUTLINE NO.	LAND PATTERN NO.
6 Ultra-Thin LGA	Y61A1+2	21-0190	90-0233

Tiny Low-Noise Amplifiers for HSPA/LTE

Revision History

REVISION NUMBER	REVISION DATE	DESCRIPTION	PAGES CHANGED
0	8/10	Initial release	—

MAX2666/MAX2668

Maxim cannot assume responsibility for use of any circuitry other than circuitry entirely embodied in a Maxim product. No circuit patent licenses are implied. Maxim reserves the right to change the circuitry and specifications without notice at any time.

Maxim Integrated Products, 120 San Gabriel Drive, Sunnyvale, CA 94086 408-737-7600 _____ 9

Looking for pricing, stock, or lifecycle information?

Click below to explore more details on WIN SOURCE:

 [View MAX2668EYT+ on WIN SOURCE](#)

 [Analog Devices Inc. Information](#)

Optimize Your Supply Chain with WIN SOURCE Solutions

-  Global Sourcing Solution
-  Obsolete Management
-  Cost Control Management
-  Shortage Management
-  Alternative Solution
-  Excess Inventory Management