

MAX2687/MAX2689/MAX2694

GPS/GNSS Low-Noise Amplifiers

General Description

The MAX2687/MAX2689/MAX2694 low-noise amplifiers (LNAs) are designed for GPS L1, Galileo, and GLONASS applications. Designed in Maxim's advanced SiGe process, the devices achieve high gain and low noise figure while maximizing the input-referred 1dB compression point and the 3rd-order intercept point. The MAX2687/MAX2689/MAX2694 provide high gains of 12dB, 15dB, and 18dB, respectively. Each is optimized for high linearity.

The devices operate from a +1.6V to +3.6V single supply. The optional shutdown feature in the devices reduces the supply current to less than 10 μ A. The devices are available in a very small, lead-free, RoHS-compliant, 0.86mm x 0.86mm x 0.65mm wafer-level package (WLP).

Applications

Telematics (Asset Tracking and Management)
 Personal Navigation Devices (PNDs)
 Cellular Phones with GPS
 Notebook PCs/Ultra-Mobile PCs
 Recreational, Marine Navigation
 Avionics
 Watches
 Digital Cameras

Features

- ◆ **High Power Gain: 17.8dB (MAX2687)**
- ◆ **Low Noise Figure: 0.85dB (MAX2687)**
- ◆ **Integrated 50 Ω Output Matching Circuit**
- ◆ **Low Supply Current: 4.5mA (MAX2694)**
- ◆ **Wide Supply Voltage Range: 1.6V to 3.6V**
- ◆ **Low Bill of Materials: One Inductor, Two Capacitors**
- ◆ **Small Footprint: 0.86mm x 0.86mm**
- ◆ **0.4mm-Pitch Wafer-Level Package (WLP)**

[Ordering Information](#) appears at end of data sheet.

Typical Application Circuit

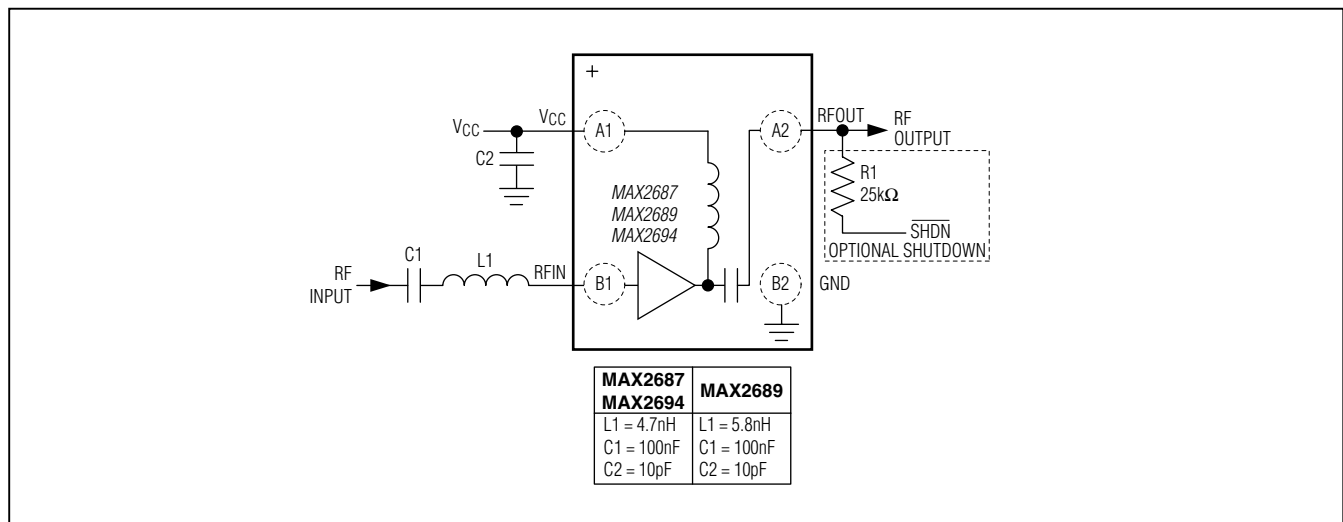

For pricing, delivery, and ordering information, please contact Maxim Direct at 1-888-629-4642, or visit Maxim's website at www.maximintegrated.com.

MAX2687/MAX2689/MAX2694

GPS/GNSS Low-Noise Amplifiers

ABSOLUTE MAXIMUM RATINGS

VCC to GND.....	-0.3V to +3.6V	Maximum Current into RF Input	10mA
Other Pins to GND	-0.3V to (+ Operating VCC + 0.3V)	Operating Temperature Range	-40°C to +85°C
Maximum RF Input Power	+5dBm	Junction Temperature	+150°C
Continuous Power Dissipation (TA = +70°C)		Storage Temperature Range.....	-65°C to +160°C
4-Bump WLP (derates 9.7mW/°C above +70°C)	776mW	Soldering Temperature (reflow) (Note 1)	+260°C

Note 1: Refer to Application Note 1891: *Wafer-Level Packaging (WLP) and Its Applications*.

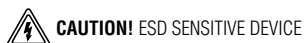

Stresses beyond those listed under “Absolute Maximum Ratings” may cause permanent damage to the device. These are stress ratings only, and functional operation of the device at these or any other conditions beyond those indicated in the operational sections of the specifications is not implied. Exposure to absolute maximum rating conditions for extended periods may affect device reliability.

PACKAGE THERMAL CHARACTERISTICS (Note 2)

WLP
 Junction-to-Ambient Thermal Resistance (θ_{JA}) 103°C/W

Note 2: Package thermal resistances were obtained using the method described in JEDEC specification JESD51-7, using a four-layer board. For detailed information on package thermal considerations, refer to www.maximintegrated.com/thermal-tutorial.

DC ELECTRICAL CHARACTERISTICS

(MAX2687/MAX2689/MAX2694 EV kit, VCC = 1.6V to 3.6V, TA = -40°C to +85°C, no RF signals are applied. Typical values are at VCC = 2.85V and TA = +25°C, unless otherwise noted.) (Note 3)

PARAMETER	CONDITIONS	MIN	TYP	MAX	UNITS
Supply Voltage		1.6	2.85	3.6	V
Supply Current	SHDN = high	MAX2687	7.6		mA
		MAX2689	7.6		
	MAX2694	4.5			
	Shutdown mode, $V_{SHDN} = 0V$			20	μA
Digital Input Logic-High	(Note 4)	1.2			V
Digital Input Logic-Low	(Note 4)			0.45	V

AC ELECTRICAL CHARACTERISTICS

(MAX2687/MAX2689/MAX2694 EV kit, VCC = 1.6V to 3.6V, TA = -40°C to +85°C, fRFIN = 1575.42MHz. Typical values are at VCC = 2.85V and TA = +25°C, unless otherwise noted.) (Note 3)

PARAMETER	CONDITIONS	MIN	TYP	MAX	UNITS
RF Frequency	L1 band		1575.42		MHz
Power Gain	VCC = 2.85V (Note 5)	MAX2687	14.7	17.8	dB
		MAX2689	12.1	15.1	
		MAX2694	8.9	11.6	
	VCC = 1.6V	MAX2687	14.0	17.7	
		MAX2689	11.8	15	
		MAX2694	8.7	11.5	

MAX2687/MAX2689/MAX2694

GPS/GNSS Low-Noise Amplifiers

AC ELECTRICAL CHARACTERISTICS (continued)

(MAX2687/MAX2689/MAX2694 EV kit, V_{CC} = 1.6V to 3.3V, T_A = -40°C to +85°C, f_{RFIN} = 1575.42MHz. Typical values are at V_{CC} = 2.85V and T_A = +25°C, unless otherwise noted.) (Note 3)

PARAMETER	CONDITIONS	MIN	TYP	MAX	UNITS
Noise Figure	VCC = 1.6V to 3.3V	MAX2687	0.85		dB
		MAX2689	1.2		
		MAX2694	0.97		
In-Band 3rd-Order Input Intercept Point	(Note 6)	MAX2687	5.5		dBm
		MAX2689	5.1		
		MAX2694	6.85		
Out-of-Band 3rd-Order Input Intercept Point	(Note 7)	MAX2687	9.146		dBm
		MAX2689	8		
		MAX2694	8.644		
Input 1dB Compression Point	(Note 8)	MAX2687	-9.3		dBm
		MAX2689	-8.9		
		MAX2694	-2.25		
Input Return Loss	MAX2687		7.8		dB
	MAX2689		9		
	MAX2694		16.8		
Output Return Loss	MAX2687		20.7		dB
	MAX2689		15.2		
	MAX2694		11.6		
Reverse Isolation	MAX2687		43.9		dB
	MAX2689		43.3		
	MAX2694		21.5		

Note 3: Min and max limits guaranteed by test at T_A = +25°C and guaranteed by design and characterization at T_A = -40°C and T_A = +85°C, unless otherwise noted.

Note 4: Min and max limits guaranteed by test at T_A = +25°C.

Note 5: Min limit guaranteed by design and characterization.

Note 6: Measured with the two tones located at 1MHz and 2MHz offset from the center of the GPS band with -27dBm/tone for the MAX2687, -30dBm/tone for the MAX2689, and -24dBm/tone for the MAX2694.

Note 7: Measured with input tones at 1713MHz (-27dBm) and 1851MHz (-39dBm).

Note 8: Measured with a tone located at the center of the GPS band.

MAX2687/MAX2689/MAX2694

GPS/GNSS Low-Noise Amplifiers

Typical Operating Characteristics

(MAX2687/MAX2689/MAX2694 EV kit. Typical values are at $V_{CC} = 2.85V$, $T_A = +25^\circ C$, and $f_{RFIN} = 1575.42MHz$, unless otherwise noted.)

MAX2687

INPUT RETURN LOSS vs. FREQUENCY

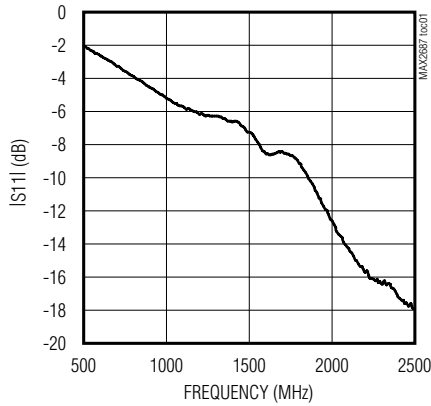

GAIN vs. FREQUENCY

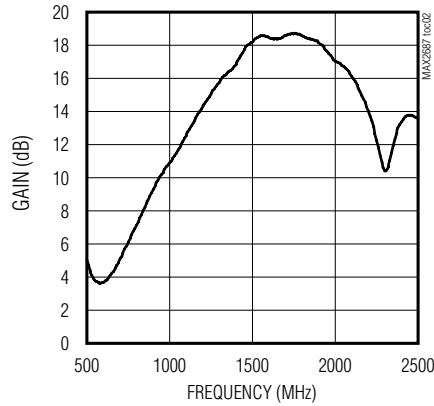

REVERSE ISOLATION vs. FREQUENCY

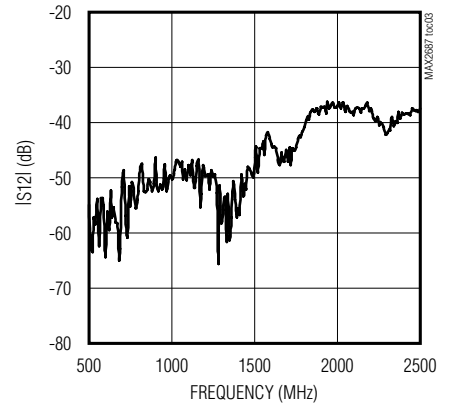

OUTPUT RETURN LOSS vs. FREQUENCY

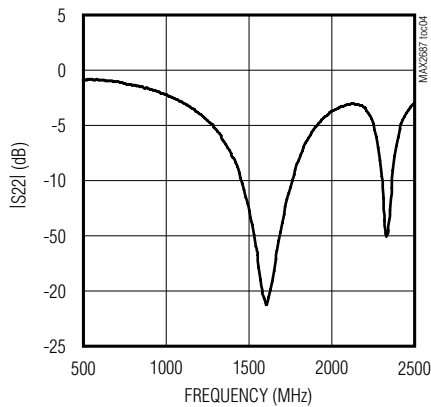

IN-BAND IIP3 vs. SUPPLY VOLTAGE AND TEMPERATURE

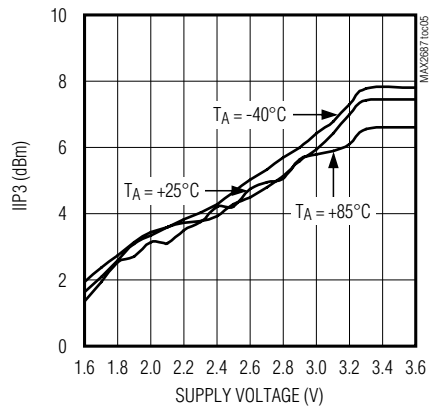

OUT-OF-BAND IIP3 vs. SUPPLY VOLTAGE AND TEMPERATURE

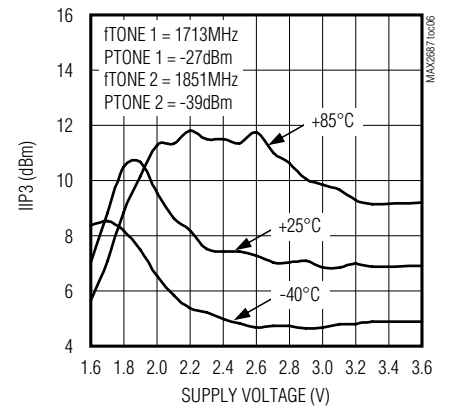

INPUT P1dB vs. SUPPLY VOLTAGE AND TEMPERATURE

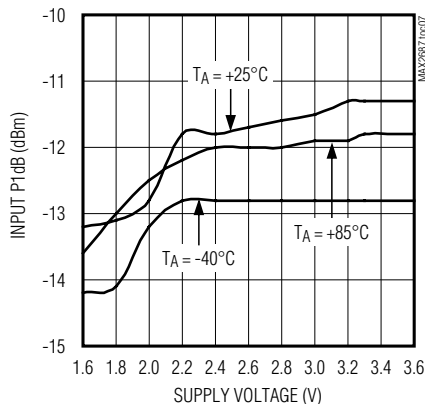

1dB GAIN DESENSE vs. BLOCKER FREQUENCY

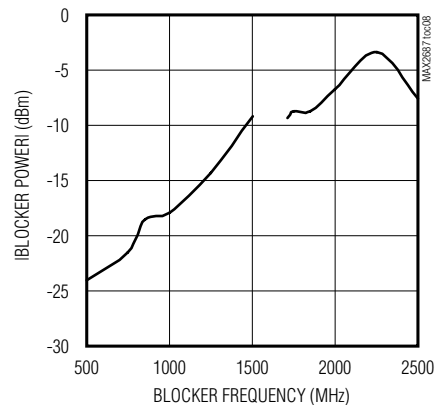

MAX2687/MAX2689/MAX2694

GPS/GNSS Low-Noise Amplifiers

Typical Operating Characteristics (continued)

(MAX2687/MAX2689/MAX2694 EV kit. Typical values are at $V_{CC} = 2.85V$, $T_A = +25^\circ C$, and $f_{RFIN} = 1575.42MHz$, unless otherwise noted.)

MAX2694

INPUT RETURN LOSS vs. FREQUENCY

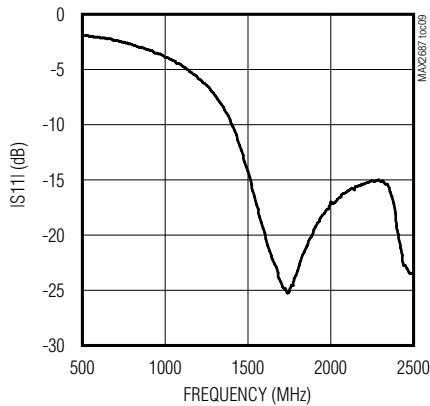

GAIN vs. FREQUENCY

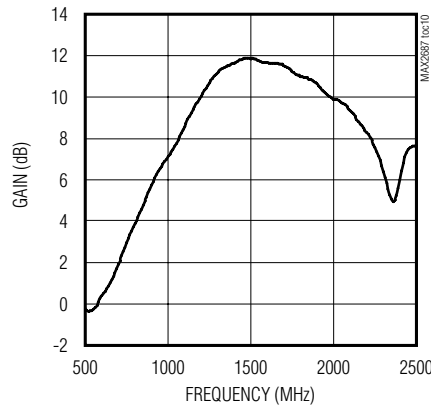

REVERSE ISOLATION vs. FREQUENCY

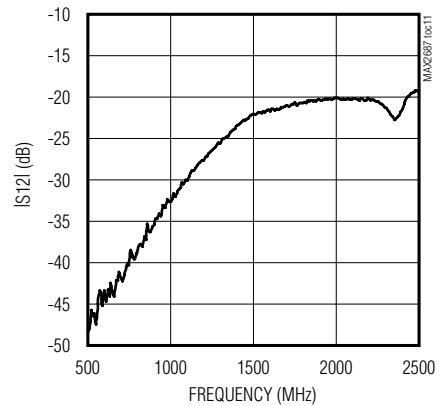

OUTPUT RETURN LOSS vs. FREQUENCY

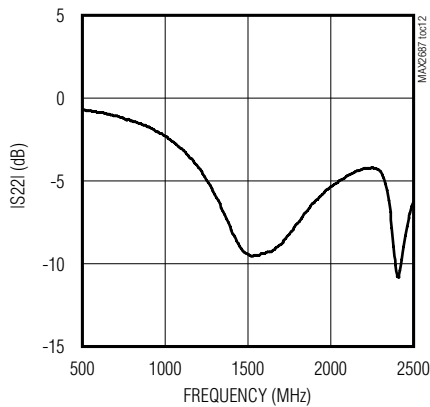

IN-BAND IIP3 vs. SUPPLY VOLTAGE AND TEMPERATURE

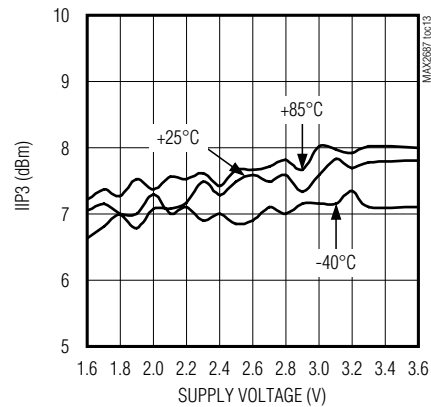

OUT-OF-BAND IIP3 vs. SUPPLY VOLTAGE AND TEMPERATURE

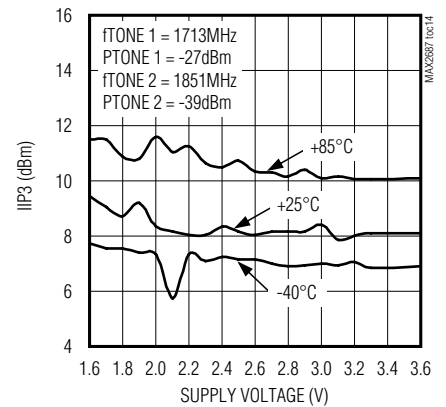

INPUT P1dB vs. SUPPLY VOLTAGE AND TEMPERATURE

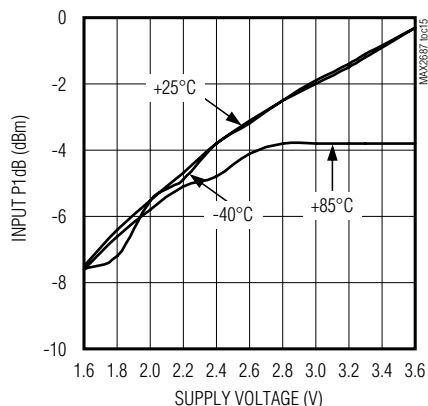

1dB GAIN DESENSE vs. BLOCKER FREQUENCY

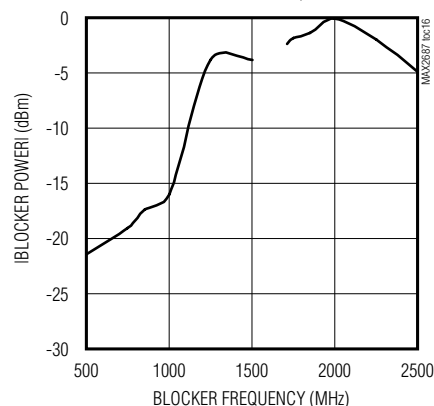

MAX2687/MAX2689/MAX2694

GPS/GNSS Low-Noise Amplifiers

Typical Operating Characteristics (continued)

(MAX2687/MAX2689/MAX2694 EV kit. Typical values are at $V_{CC} = 2.85V$, $T_A = +25^\circ C$, and $f_{RFIN} = 1575.42MHz$, unless otherwise noted.)

MAX2689

INPUT RETURN LOSS vs. FREQUENCY

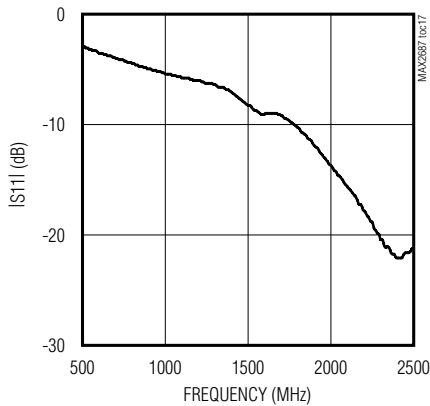

GAIN vs. FREQUENCY

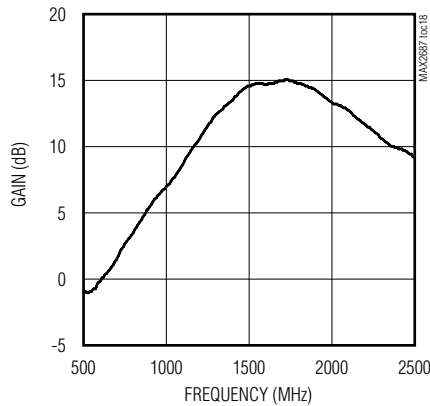

REVERSE ISOLATION vs. FREQUENCY

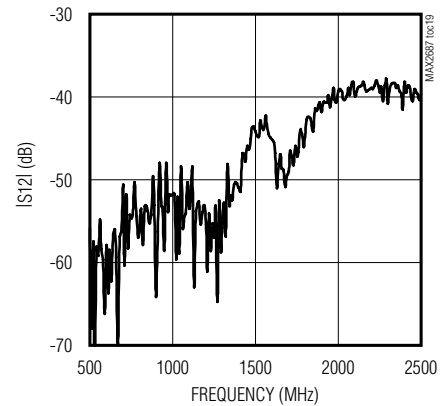

OUTPUT RETURN LOSS vs. FREQUENCY

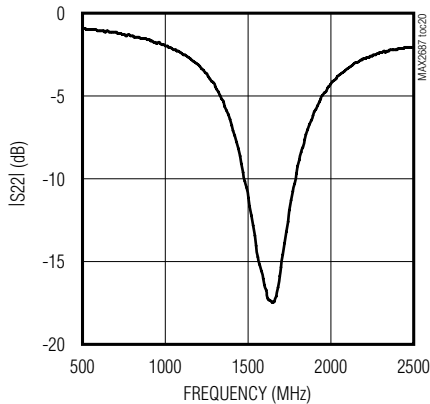

**IN-BAND IIP3 vs. SUPPLY VOLTAGE AND TEMPERATURE
(TWO TONES LOCATED AT 1MHz AND 2MHz OFFSET WITH -30dBm/TONE)**

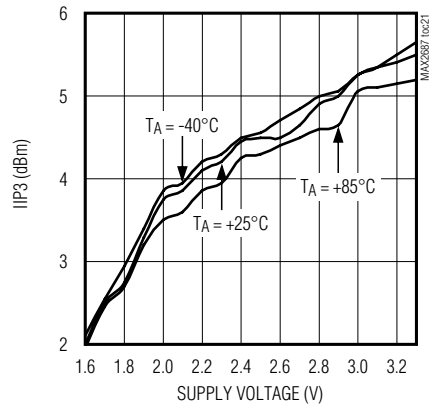

**OUT-OF-BAND IIP3 vs. SUPPLY VOLTAGE AND TEMPERATURE
(TONE 1 AT 1713MHz, -27dBm; TONE 2 AT 1851MHz, -39dBm)**

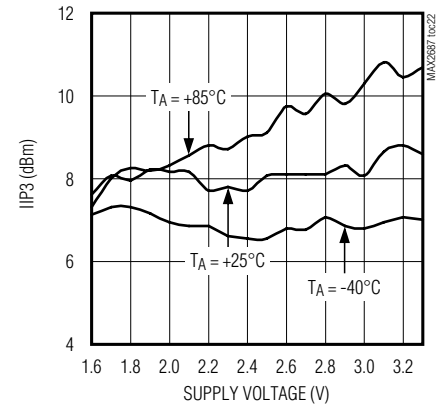

INPUT P1dB COMPRESSION vs. SUPPLY VOLTAGE AND TEMPERATURE

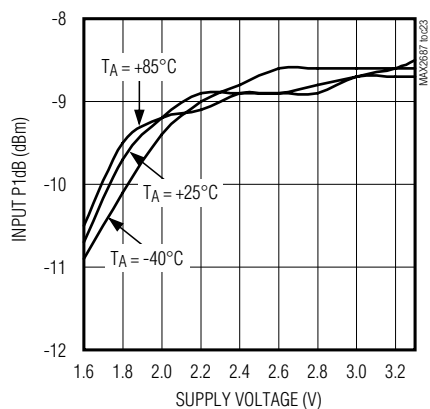

1dB GAIN DESENSE vs. BLOCKER FREQUENCY

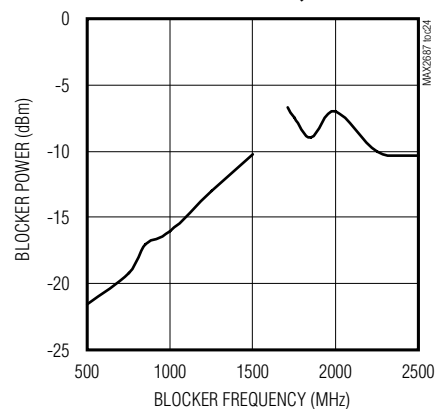

MAX2687/MAX2689/MAX2694

GPS/GNSS Low-Noise Amplifiers

Bump Configuration

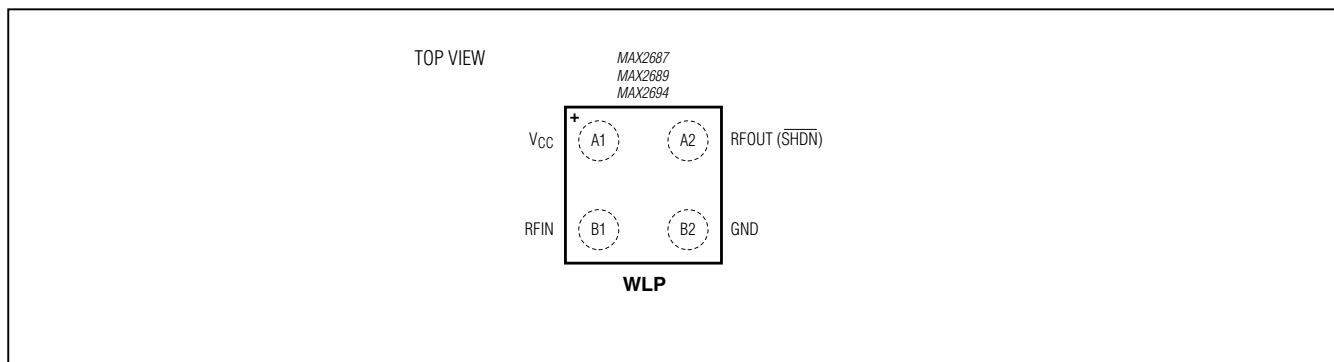

Bump Description

BUMP	NAME	FUNCTION
A1	VCC	Supply Voltage. Bypass to ground with a 10pF capacitor as close as possible to the IC.
A2	RFOUT (SHDN)	RF Output/ $\overline{\text{SHDN}}$ Input. RFOUT is internally matched to 50 Ω and pulled up to VCC through a 1M Ω resistor. $\overline{\text{SHDN}}$ is shared with the RFOUT bump. The devices are in active mode by default once VCC is applied. RFOUT($\overline{\text{SHDN}}$) can be pulled to a DC low through a 25k Ω resistor to shut down the IC.
B1	RFIN	RF Input. Requires a DC-blocking capacitor and external matching components.
B2	GND	Ground. Connect to the PCB ground plane.

Detailed Description

The MAX2687/MAX2689/MAX2694 are LNAs designed for GPS L1, Galileo, and GLONASS applications. The devices feature an optional power-shutdown control mode to eliminate the need for an external supply switch. The devices achieve high gain, low noise figure, and excellent linearity.

Input and Output Matching

The devices require an off-chip input matching. Only an inductor in series with a DC-blocking capacitor is needed to form the input matching circuit. The *Typical Application Circuit* shows the recommended input-matching network. These values are optimized for the best simultaneous gain, noise figure, and return loss performance. The value of the input coupling capacitor

affects IIP3. A smaller coupling capacitor results in lower IIP3. The devices integrate an on-chip output matching to 50 Ω at the output, eliminating the need for external matching components. Tables 1 and 2 list typical device S parameters and K_f values. Typical noise parameters are shown in Tables 3 and 4.

Shutdown

The devices include an optional shutdown feature to turn off the entire chip. The devices are placed in active mode by default once VCC is applied, due to the on-chip pullup resistor to VCC at the RFOUT bump (shared with the $\overline{\text{SHDN}}$ input). To shut down the part, apply a logic-low to the RFOUT bump through an external resistor with an adequate value, e.g., 25k Ω , in order not to load the RF output signal during active operation.

MAX2687/MAX2689/MAX2694

GPS/GNSS Low-Noise Amplifiers

Table 1. MAX2687 Typical S Parameter Values and K-Factor

FREQ (MHz)	S11 MAG (dB)	S11 PHASE (DEGREES)	S21 MAG (dB)	S21 PHASE (DEGREES)	S12 MAG (dB)	S12 PHASE (DEGREES)	S22 MAG (dB)	S22 PHASE (DEGREES)	Kf
1000	-3.9	-91.5	10.1	164.7	-48.4	96.6	-2.2	-154.8	10.0
1100	-4.1	-97.6	11.7	152.8	-51.2	47.8	-2.9	-175.2	14.0
1200	-4.4	-103.6	13.3	136.5	-47.3	42.2	-3.9	164.0	9.6
1300	-4.3	-109.6	14.6	118.8	-53.1	80.2	-5.4	140.3	19.1
1400	-4.0	-116.9	15.6	102.3	-55.0	152.6	-7.5	112.1	23.4
1500	-3.9	-127.1	17.0	82.1	-45.7	119.1	-11.7	70.7	7.6
1575	-4.5	-133.3	17.3	63.7	-44.5	72.7	-18.1	15.0	7.3
1600	-4.7	-133.6	17.1	56.9	-46.9	36.4	-20.9	-18.1	10.1
1700	-4.2	-140.0	17.1	39.7	-48.8	77.8	-14.7	-100.3	11.4
1800	-4.2	-150.0	17.0	18.6	-41.6	76.6	-8.8	-137.7	4.3
1900	-4.5	-159.2	16.6	-1.5	-39.2	39.1	-5.6	-168.2	2.9
2000	-4.8	-166.3	15.5	-20.2	-37.6	17.5	-4.0	163.7	2.3

Table 2. MAX2689 Typical S Parameter Values and K-Factor

FREQ (MHz)	S11 MAG (dB)	S11 PHASE (DEGREES)	S21 MAG (dB)	S21 PHASE (DEGREES)	S12 MAG (dB)	S12 PHASE (DEGREES)	S22 MAG (dB)	S22 PHASE (DEGREES)	Kf
1000	-3.8	-93.0	6.0	150.9	-52.1	80.8	-1.9	-161.7	21.6
1100	-3.8	-100.5	7.7	140.7	-62.5	44.2	-2.4	-178.8	68.3
1200	-4.0	-107.8	9.3	124.7	-53.9	19.6	-3.2	164.4	26.5
1300	-3.9	-115.5	10.8	107.7	-56.2	55.3	-4.3	145.5	34.8
1400	-3.8	-124.9	12.1	89.7	-49.8	124.0	-6.5	124.1	17.5
1500	-4.2	-133.5	13.1	65.2	-43.4	53.2	-11.5	113.3	9.6
1575	-4.2	-136.3	12.9	50.7	-47.2	12.5	-14.7	120.9	15.6
1600	-4.1	-138.4	12.9	45.3	-48.3	12.9	-16.5	126.1	17.6
1700	-3.9	-146.3	13.1	25.9	-51.5	74.0	-16.0	-177.6	24.1
1800	-3.8	-155.2	12.7	5.3	-46.7	71.0	-9.8	-174.3	12.9
1900	-3.9	-163.6	12.2	-13.7	-42.9	43.0	-6.4	171.4	7.6
2000	-4.0	-170.6	11.2	-29.8	-41.6	27.0	-4.5	154.6	6.1

MAX2687/MAX2689/MAX2694

GPS/GNSS Low-Noise Amplifiers

Table 3. MAX2694 Typical S Parameter Values and K-Factor

FREQ (MHz)	S11 MAG (dB)	S11 PHASE (DEGREES)	S21 MAG (dB)	S21 PHASE (DEGREES)	S12 MAG (dB)	S12 PHASE (DEGREES)	S22 MAG (dB)	S22 PHASE (DEGREES)	K _f
1000	-2.7	-106.3	5.8	145.8	-33.4	103.0	-2.2	-160.9	2.7
1100	-3.0	-117.0	7.1	133.6	-31.1	95.5	-2.8	-179.0	2.4
1200	-3.4	-127.6	8.5	117.1	-29.0	81.3	-3.8	163.5	2.1
1300	-4.0	-138.6	9.7	98.3	-26.8	67.7	-5.3	145.9	1.9
1400	-4.9	-149.8	10.3	79.8	-24.9	55.3	-7.6	130.7	1.8
1500	-6.2	-158.2	10.8	59.9	-22.9	36.8	-10.8	126.6	1.6
1575	-7.0	-159.5	10.7	46.2	-22.4	21.7	-12.3	132.7	1.6
1600	-7.2	-160.0	10.6	41.3	-22.5	17.5	-12.7	134.9	1.6
1700	-7.7	-163.0	10.6	23.5	-22.0	4.0	-12.9	150.7	1.5
1800	-8.2	-164.6	10.2	6.2	-21.3	-11.5	-10.3	158.0	1.4
1900	-8.1	-165.5	9.9	-11.7	-21.2	-26.8	-7.7	150.4	1.3
2000	-7.7	-167.3	9.0	-27.0	-20.9	-42.3	-5.9	137.5	1.2

Table 4. MAX2687 Typical Noise Parameters (V_{CC} = 2.85V, T_A = +25°C)

FREQUENCY (MHz)	FMIN (dB)	Γ _{OPT}	Γ _{OPT} ANGLE	R _N (Ω)
1550	0.69	0.26	66	5.28
1560	0.69	0.26	66	5.27
1570	0.69	0.26	67	5.27
1575	0.69	0.25	67	5.26
1580	0.69	0.25	67	5.26
1590	0.70	0.25	68	5.26
1600	0.70	0.25	68	5.25

Table 5. MAX2689 Typical Noise Parameters (V_{CC} = 2.85V, T_A = +25°C)

FREQUENCY (MHz)	FMIN (dB)	Γ _{OPT}	Γ _{OPT} ANGLE	R _N (Ω)
1550	0.80	0.27	73	5.89
1560	0.80	0.27	74	5.87
1570	0.81	0.27	74	5.86
1580	0.81	0.27	75	5.85
1590	0.81	0.27	75	5.84
1600	0.81	0.27	76	5.83

MAX2687/MAX2689/MAX2694

GPS/GNSS Low-Noise Amplifiers

Table 6. MAX2694 Typical Noise Parameters ($V_{CC} = 2.85V$, $T_A = +25^\circ C$)

FREQUENCY (MHz)	FMIN (dB)	$ \Gamma_{OPT} $	$ \Gamma_{OPT} $ ANGLE	R_N (Ω)
1550	0.75	0.44	48	9.06
1560	0.75	0.44	48	9.04
1570	0.75	0.44	48	9.02
1575	0.75	0.43	49	9.01
1580	0.75	0.43	49	9.00
1590	0.75	0.43	49	8.98
1600	0.75	0.43	49	8.96

Applications Information

A properly designed PCB is essential to any RF micro-wave circuit. Use controlled-impedance lines on all high-frequency inputs and outputs. Bypass V_{CC} with decoupling capacitors located close to the device. For long V_{CC} lines, it may be necessary to add decoupling capacitors. Locate these additional capacitors further away from the device package. Proper grounding of the GND bump is essential. If the PCB uses a topside RF ground, connect it directly to the GND bump. For a board where the ground is not on the component layer, connect the GND bump to the board with multiple vias close to the package.

Refer to www.maximintegrated.com/datasheet/index.mvp/id/6932/t/do for the MAX2687/MAX2689/MAX2694 EV kit schematic, Gerber data, PADS layout file, and BOM information.

Chip Information

PROCESS: SiGe BiCMOS

Ordering Information

PART	TEMP RANGE	PIN-PACKAGE
MAX2687EWS+T	-40°C to +85°C	4 WLP
MAX2689EWS+T	-40°C to +85°C	4 WLP
MAX2694EWS+T	-40°C to +85°C	4 WLP

+Denotes a lead(Pb)-free/RoHS-compliant package.
T = Tape and reel.

Package Information

For the latest package outline information and land patterns (foot-prints), go to www.maximintegrated.com/packages. Note that a "+", "#", or "-" in the package code indicates RoHS status only. Package drawings may show a different suffix character, but the drawing pertains to the package regardless of RoHS status.

PACKAGE TYPE	PACKAGE CODE	OUTLINE NO.	LAND PATTERN NO.
4 WLP	W40A0+1	21-0480	Refer to Application Note 1891

MAX2687/MAX2689/MAX2694

GPS/GNSS Low-Noise Amplifiers

Revision History

REVISION NUMBER	REVISION DATE	DESCRIPTION	PAGES CHANGED
0	9/11	Initial release	—
1	5/12	Added MAX2689 to data sheet	All
2	10/13	Revised <i>AC Electrical Characteristics</i> table	2



Maxim Integrated cannot assume responsibility for use of any circuitry other than circuitry entirely embodied in a Maxim Integrated product. No circuit patent licenses are implied. Maxim Integrated reserves the right to change the circuitry and specifications without notice at any time. The parametric values (min and max limits) shown in the Electrical Characteristics table are guaranteed. Other parametric values quoted in this data sheet are provided for guidance.

Maxim Integrated 160 Rio Robles, San Jose, CA 95134 USA 1-408-601-1000

11

Looking for pricing, stock, or lifecycle information?

Click below to explore more details on WIN SOURCE:

 [View MAX2694EWS+T on WIN SOURCE](#)

 [Analog Devices Inc. Information](#)

Optimize Your Supply Chain with WIN SOURCE Solutions

-  Global Sourcing Solution
-  Obsolete Management
-  Cost Control Management
-  Shortage Management
-  Alternative Solution
-  Excess Inventory Management