

# CR2032

## CR Coin-type Lithium Battery

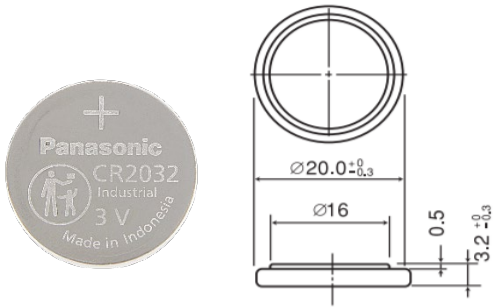

### Features & Benefits

- Offers high-rate pulse discharge
- Available in a range of compact sizes and capacities, from thin-type to high-capacity models
- Excellent low-temperature performance enhanced by manganese-dioxide positive pole

### Applications

Remote keyless entry, Card remote controls, memory backup, security price tags, smart transmitter tags and others.

#### Discharge temperature characteristics

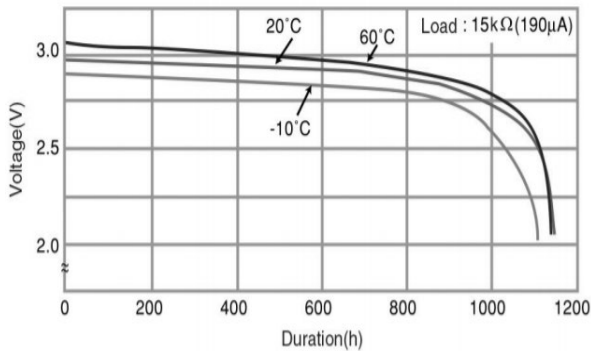

#### Capacity vs. load resistance

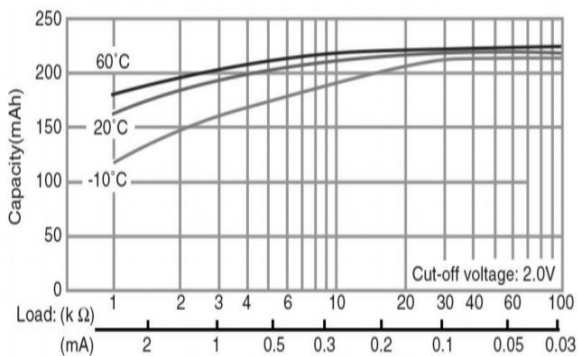

### Specifications

Nominal voltage		3V
Nominal capacity		225mAh
Continuous drain		0.2mA
Dimensions* 1	Diameter(Max.)	20.0mm
	Height(Max.)	3.2mm
Weight*1		Approx. 2.8g
Operating temperature*2		-30°C to +85°C

\*1 Without tabs.

\*2 Please consult Panasonic when anticipating usage in operating temperatures of 70°C or above.

### Terminal types

Please see the documents for the terminal and lead wire settings.

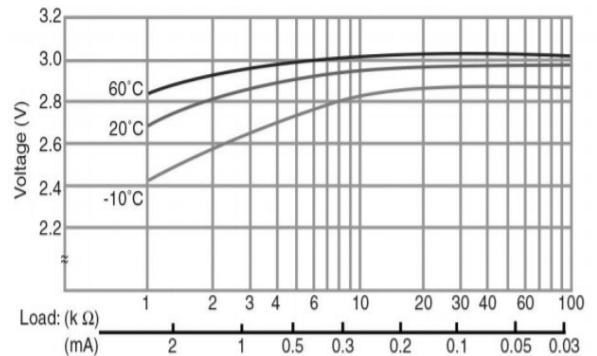

- [Line up of tab terminal types\(by shape\)](#)
- [Line up of tab terminal types\(by product number\)](#)

#### Operating voltage vs. load resistance (voltage at 50% discharge depth)





## Looking for pricing, stock, or lifecycle information?

Click below to explore more details on WIN SOURCE:

-  [View CR2032/BN on WIN SOURCE](#)
-  [Panasonic Information](#)

## Optimize Your Supply Chain with WIN SOURCE Solutions

-  Global Sourcing Solution
-  Obsolete Management
-  Cost Control Management
-  Shortage Management
-  Alternative Solution
-  Excess Inventory Management