

## FEATURES

- Unconditional Stability
- RF Ports Matched to 50 Ohms
- Internal DC Voltage Regulation
- Reverse Polarity Protection
- RoHS Compliant
- Hermetically Sealed Kovar Package

## TYPICAL APPLICATIONS

- Wireless Infrastructure
- RF Microwave and VSAT
- Military and Aerospace
- Test Instruments
- Fiber Optics

## ELECTRICAL SPECIFICATIONS (@ 23°C)

Parameter	Min	Max	Typ	Units
Frequency Range	26.0	40.0	-	GHz
Noise Figure	-	2.7	2.2	dB
Gain (S21)	40	-	44	dB
Gain Flatness	-	2.5	2.3	± dB
Output Power @ 1dB Compression Point (P1dB)	+10	-	+11	dBm
Input VSWR (S11)	-	2.5	1.8	-
Output VSWR (S22)	-	2.5	1.8	-
DC Supply Voltage	+12	+18	+15	VDC
DC Supply Current	-	325	160	mA

### Absolute Maximum Ratings

Parameter	Rating
DC Supply Voltage	+20 V
RF Input Power	+13 dBm
Operating Temperature	-55°C to +85°C
Non-Operating Temperature	-65°C to +125°C
RF Port Coupling (In/Out)	AC Coupled / AC Coupled

### Mechanical Specifications

Parameter	Value
Length	0.94 in [23.8 mm]
Width	0.74 in [18.7 mm]
Height	0.70 in [17.8 mm]
Connectors (In/Out)	K(F) / K(F)
Approx. Weight	13.8 g

The information above is relative to the sale of a COTS product as depicted. For information regarding other amplifier features not listed for this specific LNA model, please review our product overview brochure at the following link or contact your local representative.

[LNA Series Brochure](#)

The material presented in this datasheet was current at the time of publication. Narda-MITEQ's continuing product improvement program makes it necessary to reserve the right to change our mechanical and electrical specifications without notice. If either of these parameters is critical, please contact the factory to verify that the information is current.

This material consists of Narda-MITEQ general capabilities information and does not contain controlled technical data as defined within the International Traffic in Arms (ITAR) Part 120.10 or Export Administration Regulations (EAR) Part 734.7-11. D-405/05.01.18

Typical Performance @ 23°C (Reference S/N 2143420)

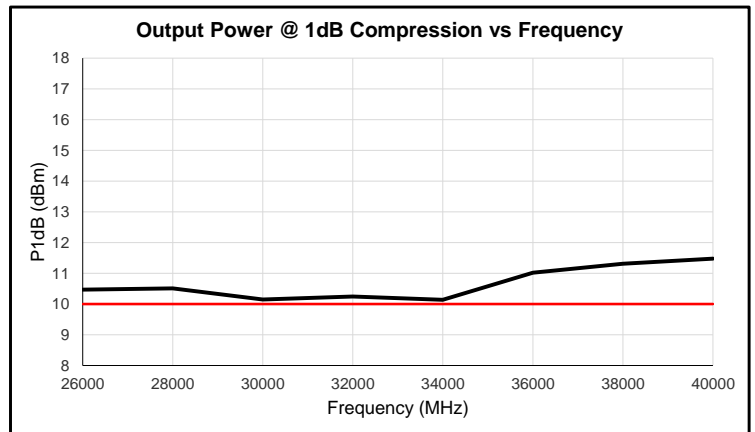
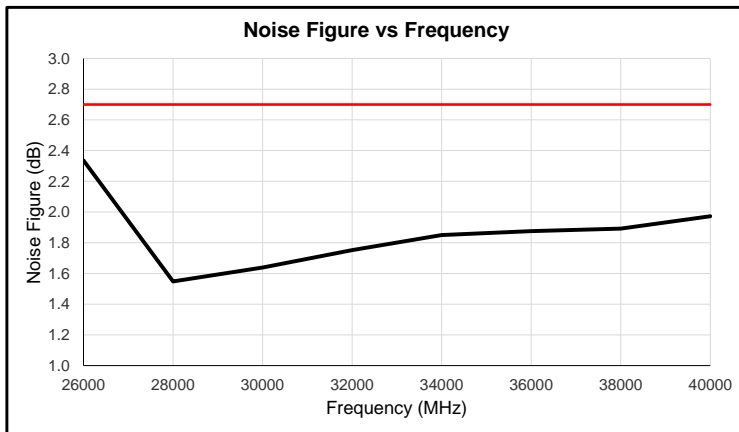
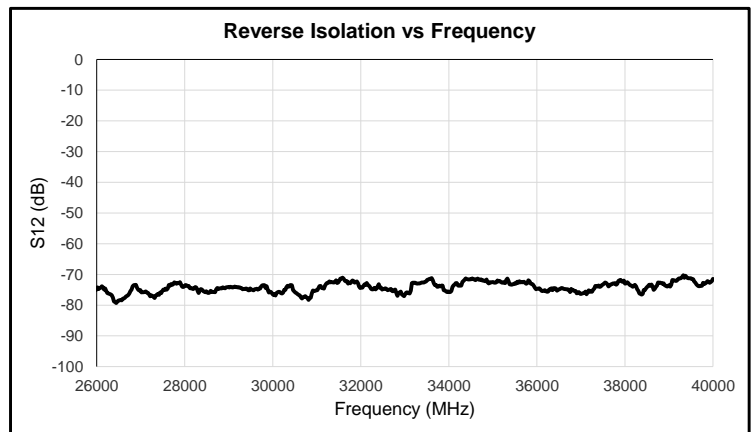
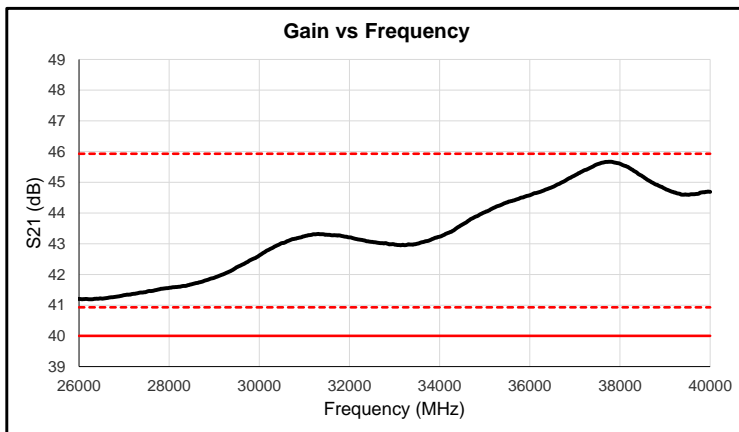
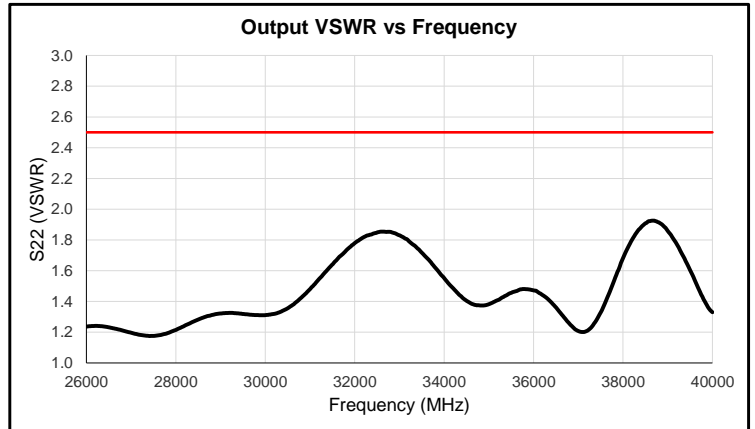
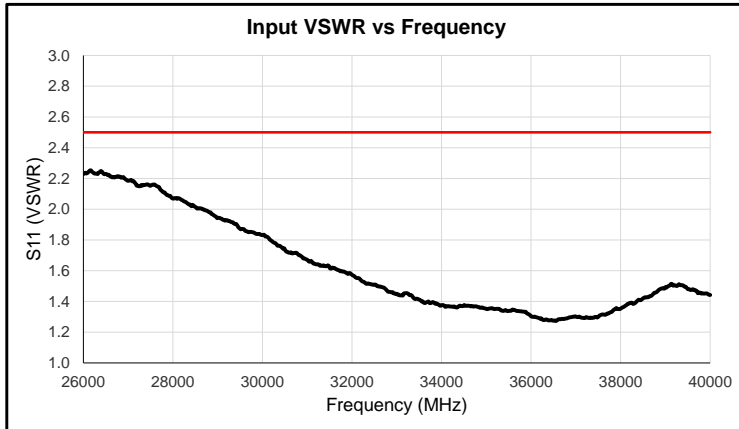

S2P file may be available upon request

Environmental Specifications		
Parameter	Standard	Description
Operational Temperature		-55°C to +85°C
Storage Temperature		-65°C to +125°C
Random Vibration	MIL-STD-883K, Method 2026, Cond. 1B	50 - 2000 Hz, 7.3 Grms
Humidity	MIL-STD-202, Method 103B, Cond. B	95% RH Non-Condensing
Altitude	MIL-STD-883K, Method 1001, Cond. C	50,000 ft

*\*This amplifier is designed to meet the above conditions. If ESS testing is required please contact factory.\**

Outline (Reference Drawing 129007)

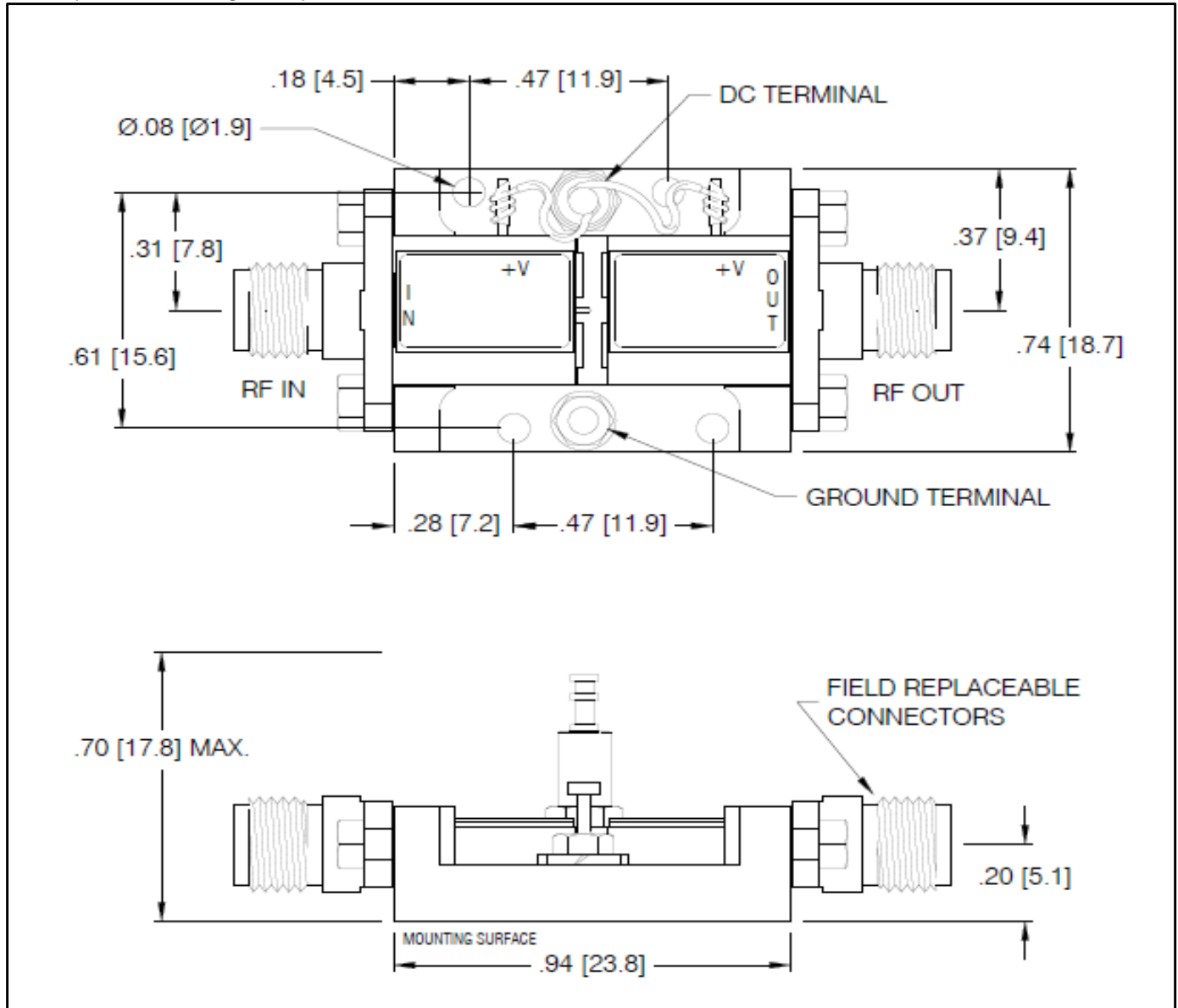

STEP file may be available upon request

## Looking for pricing, stock, or lifecycle information?

Click below to explore more details on WIN SOURCE:

- ⊖ [View LNA-40-26004000-27-10P](#) on WIN SOURCE
- ⊖ [Amphenol](#) Information

## Optimize Your Supply Chain with WIN SOURCE Solutions

- ✓ Global Sourcing Solution
- ✓ Obsolete Management
- ✓ Cost Control Management
- ✓ Shortage Management
- ✓ Alternative Solution
- ✓ Excess Inventory Management