

# TDK-Lambda PFE-SA, PFE500-F & PFE1000-FA Series

## 300-1008W AC-DC Power Modules

<http://product.tdk.com/en/power/pfe>  
[www.emea.lambda.tdk.com/pfe](http://www.emea.lambda.tdk.com/pfe)

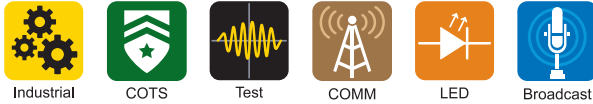

The high efficiency PFE series of AC-DC 300W to 1008W power modules are for use in environments where convection or forced air cooling is not viable. Suitable for use in outdoor enclosures or liquid cooled applications, these pcb mounted power modules accept a wide range AC input and deliver an adjustable, regulated output. High ambient temperatures can be tolerated as the conduction cooled baseplate can withstand -40 up to 100°C temperatures. The fully featured PFE500F and PFE1000FA modules offer a parallel connection for increased power, a 12V auxiliary supply and remote on/off. The semi-regulated 48V output PFE700SA provides a very high power density and up to 92% efficiency.

Features	Benefits
• Compact Low Profile Package Sizes	• Space Saving in End Equipment
• High Efficiency	• Less Waste Heat to Manage and Reduced AC Power Consumption
• Up to 100°C Rated Baseplate Temperature	• Suitable for Rugged Environments
• Conduction Cooled Via Baseplate	• For Use in Convection Cooled or Sealed Enclosures

Model Selector							
Model	Voltage (V)	Adjustable Range (V)	Max Current (A)	Max Output Power (W)	Ripple / Noise (mV)	Input Current (A) 115/230Vac	Efficiency (typ) % 115/230Vac
PFE300SA-12	12	9.6 - 14.4	25	300	120	3.3 / 1.6	84 / 86
PFE500SA-12	12	9.6 - 14.4	33	396	120	4.2 / 2.1	84 / 86
PFE500F-12	12	9.6 - 14.4	42	504	120	6.8 / 3.4(1)	81 / 83
PFE1000FA-12	12	9.6 - 14.4	60	720	120	8.0 / 3.9	84.5 / 89.5
PFE300SA-28	28	22.4 - 33.6	10.8	302	280	3.2 / 1.6	87.5 / 89.5
PFE500SA-28	28	22.4 - 33.6	18	504	280	5.2 / 2.5	88 / 90
PFE500F-28	28	22.4 - 33.6	18	504	280	6.4 / 3.2(1)	84 / 86
PFE1000FA-28	28	22.4 - 33.6	36	1008	280	10.8 / 5.3	87 / 89.5
PFE300SA-48	48	38.4 - 57.6	6.3	302	480	3.1 / 1.6	88 / 90.5
PFE500SA-48	48	38.4 - 57.6	10.5	504	480	5.1 / 2.5	90 / 91
PFE500F-48	48	38.4 - 57.6	10.5	504	480	6.4 / 3.2(1)	84 / 86
PFE1000FA-48	48	38.4 - 57.6	21	1008	480	10.6 / 5.2	88 / 90.5
PFE700SA-48	48	None	14	714	4000	7.0 / 3.4	90 / 92

<b>PFE500SA-</b>	<b>12</b>	<b>/</b>	<b>T</b>
	Output voltage 12, 28, 48		blank / T Threaded mounting hole / non threaded mounting hole

Related Products		
Type	Part Number(s)	Size (mm) / Description
Heatsink for PFE300/500SA	HAF-10L	116.8 x 25.4 x 61
Heatsink for PFE300/500SA	HAF-15L	116.8 x 38.1 x 61
Heatsink for PFE300/500SA	HAF-15T	116.8 x 38.1 x 61
Heatsink for PFE500F	HAL-F12T	122 x 35 x 69.9
Heatsink for PFE1000F	HAM-F10T	160 x 33.4 x 100
10R 5W Thermal Fuse	<a href="#">DFP10112</a>	Thermal fuse for inrush reduction

Specifications					
Model		PFE300SA PFE500SA	PFE700SA	PFE500F	PFE1000FA
<b>Input</b>					
Input Voltage Range	Vac	85 - 265			
Input Frequency	Hz	47 - 63 (Contact factory for 400Hz operation)			
Input Current	A	See model selector table			
Inrush Current at 230Vac (typ) (Cold Start)	A	46 (with recommended inrush resistor)			
Leakage Current	mA	less than 0.75			
Power Factor (100/200Vac)	-	>0.95			
Hold Up Time (typ) at 110/220Vac Input	ms	20			
Efficiency	-	See model selector table			
Conducted & Radiated EMI	-	EN55011/EN55032-A, FCC Class A, VCCI-A (External components are required, consult Evaluation Data)			
Immunity	-	IEC61000-4-2, -3, -4, -5, -6, -8, -11 (External component are required, consult Immunity Data)			
Safety Certifications and Markings	-	IEC/UL/CSA/EN62368-1, 60950-1, CE Mark and UKCA Mark			

Immunity				
Test	Standard	Test Level	Criteria	Notes
ESD	EN61000-4-2	Air ± 8kV and contact ± 4kV	B	6kV with the external surge suppressor
Radiated Susceptibility	EN61000-4-3	80M -1GHz: 10V/m 1.4 - 2.0GHz: 3V/m 2.0 - 2.7GHz: 1V/m	A	
Electrical Fast Transient Burst	EN61000-4-4	± 2kV	B	
Surge	EN61000-4-5	Normal ± 2kV Common ± 4kV	B	
Conducted Susceptibility	EN61000-4-6	10Vrms	A	
Magnetic Fields	EN61000-4-8	30A/m	A	
Voltage Dips	EN61000-4-11	30% 500ms	B	
		60% 10ms	B	
		100% 20ms	A	
		100% 5000ms	B	

Specifications					
Model		PFE300SA PFE500SA	PFE700SA	PFE500F	PFE1000FA
<b>Output</b>					
Output Voltage Adjustment	%	See model selector table			
Switching Frequency (Main converter)	kHz	12V & 28V: 230, 48V: 180	180	230	230
Line Regulation	mV	12V: 48, 28V: 56, 48V: 96. The semi regulated PFE700SA output changes from 50 - 57V output <sup>(2)</sup>			
Load Regulation	mV	12V: 48, 28V: 56, 48V: 96. The semi regulated PFE700SA output changes from 50 - 57V output <sup>(2)</sup>			
Ripple & Noise	mV	See model selector table			
Temperature Coefficient	%/°C	0.02			
Minimum Load	-	No minimum load required			
Overcurrent Protection	%	105 - 140. Auto recovery on all models except PFE1000FA (Cycle AC to reset)			
Overvoltage Protection	-	125 - 145%	60 - 69.6V	125 - 145%	125 - 145%
Overtemperature Protection	% / V	Yes			
Remote Sense	-	No	No	Yes	Yes
Remote On/Off	-	No		Yes: High = Output On	
Parallel Operation	-	No	Yes (Droop mode)	Yes (Active Mode)	Yes (Active Mode)
<b>Environmental</b>					
Operating Temperature (Maximum)	°C	-40 to +100 (Baseplate) <sup>(3)</sup>			
Operating Humidity (non condensing)	%RH	20 - 95			
Storage Temperature	°C	-40 to +100			
Humidity (non condensing)	%RH	10 - 95			
Cooling	-	Conduction Cooled			
Altitude	m	3048	3048	3000	3048
Withstand Voltage (For 1 minute) <sup>(4)</sup>	Vac/Vdc	Input to Baseplate 2,500Vac, Input to Output 3,000Vac, Output to Baseplate 1,500Vdc for 1 minute			
Vibration (Non operating)	-	10-55Hz (Sweep for 1min.) Amplitude 0.825mm constant (Max 49.0m/s <sup>2</sup> ) X,Y,Z 1 hour each			
Shock (Non operating)	-	Less than 196m/s <sup>2</sup> , 11ms, ±X, ±Y, ±Z 3 times each			
<b>Other</b>					
Weight (Typ)	g	200	200	300	420
Size (LxWxH)	mm	116.8 x 61 x 12.7	116.8 x 61 x 12.7	122 x 70 x 12.7	160 x 100 x 13.4
Size (LxWxH)	Inches	4.6 x 2.4 x 0.5	4.6 x 2.4 x 0.5	4.8 x 2.76 x 0.5	6.3 x 3.94 x 0.53
MTBF - Telcordia SR-332 issue 3(5)	Hours	1,641,918	1,662,809	774,640	1,512,925
Warranty	yrs	5	5	2	5

#### Notes

See website for detailed specifications, test methods and installation manual

Important: External components are required for operation. See instruction manual

(1) 100 / 200Vac input

(2) Total regulation range (Line and Load)

(3) PFE500SA-12, PFE500F-12: -40 to 85°C. PFE1000FA, PFE1000FA-48: -40 to 85°C below 170Vac input. See instruction manuals for derating curves

(4) PFE500F, PFE1000FA: 500Vdc Output to baseplate

(5) 40°C baseplate, Ground Benign. 100Vac input

**PFE500F Basic connection**

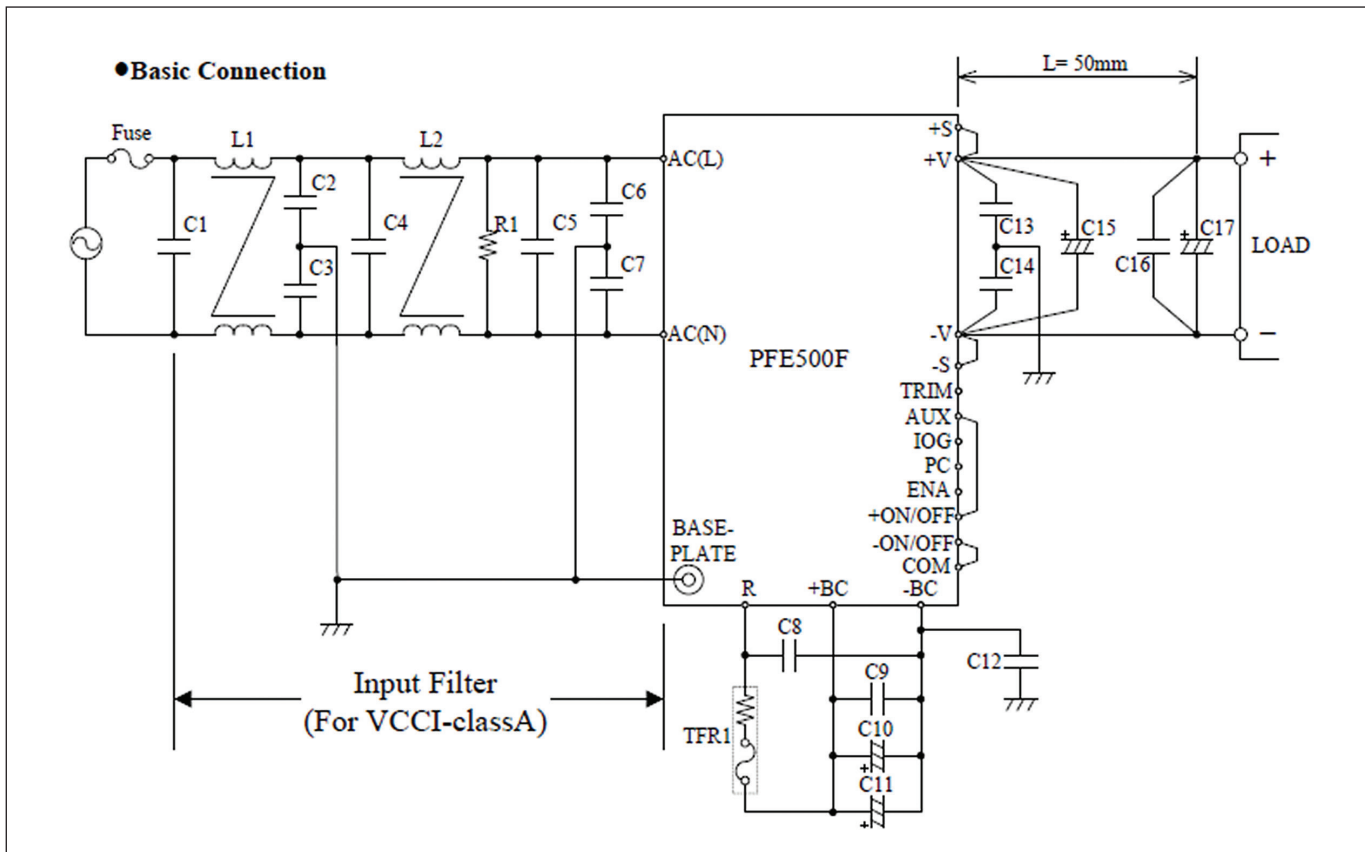

**PFE300/500SA Outline Drawing**

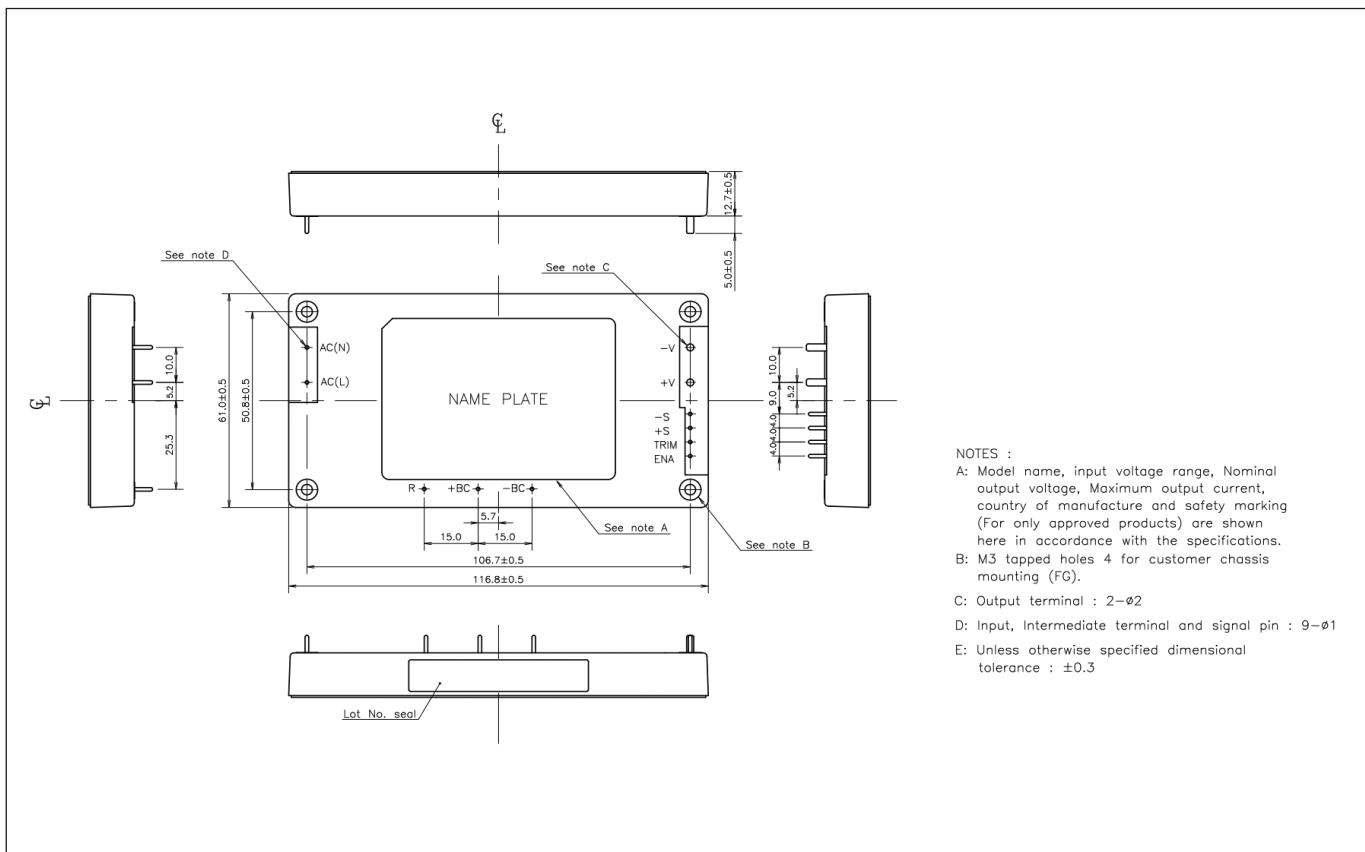



**PFE1000FA Outline Drawing**

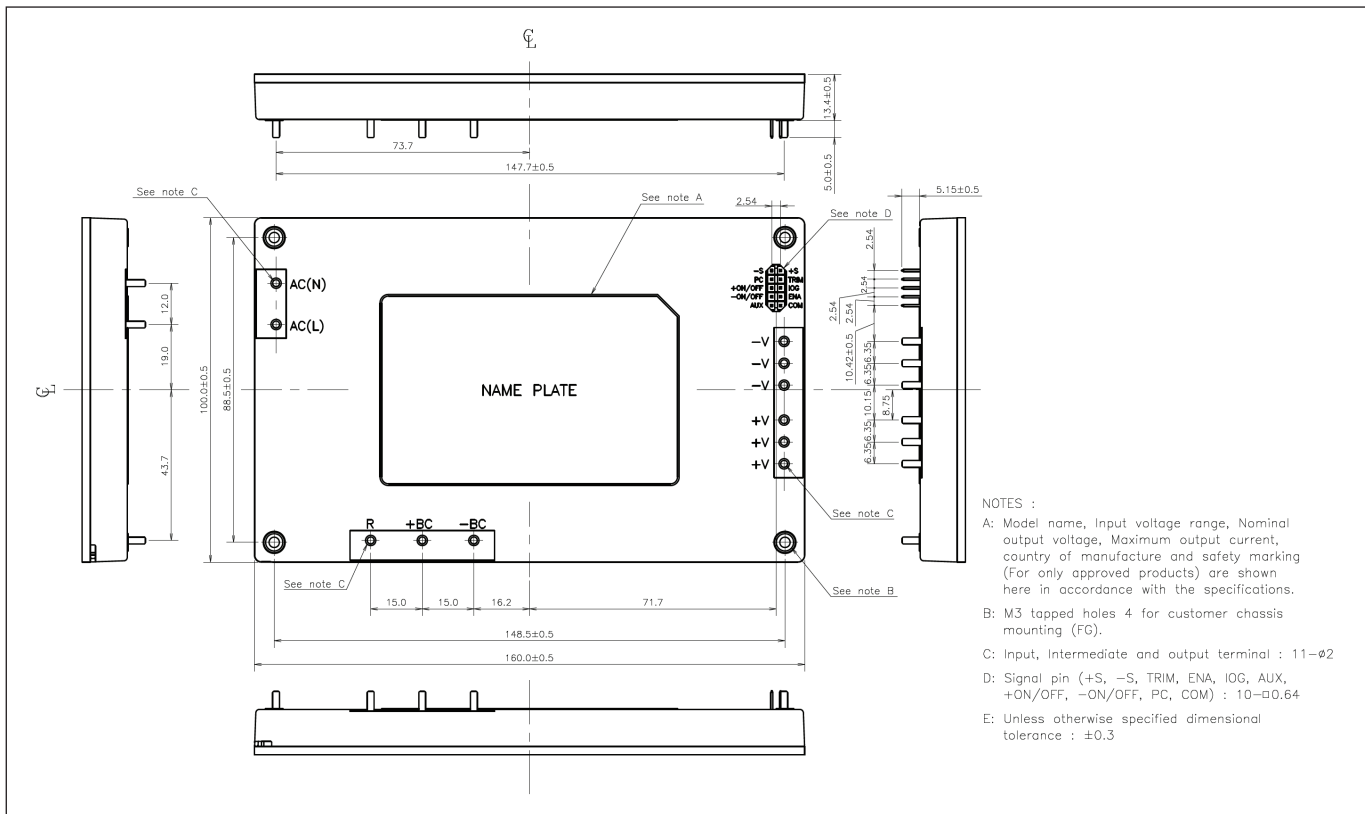



## TDK-Lambda France SAS

Tel: +33 1 60 12 71 65  
tif.fr-powersolutions@tdk.com  
www.emea.lambda.tdk.com/fr



## TDK-Lambda Americas

Tel: +1 800-LAMBDA-4 or 1-800-526-2324  
tia.powersolutions@tdk.com  
www.us.lambda.tdk.com



## Italy Sales Office

Tel +39 02 61 29 38 63  
tif.it-powersolutions@tdk.com  
www.emea.lambda.tdk.com/it



## TDK Electronics do Brasil Ltda

Tel: +55 11 3289-9599  
sales.br@tdk-electronics.tdk.com  
www.tdk-electronics.tdk.com/en



## Netherlands

tif.nl-powersolutions@tdk.com  
www.emea.lambda.tdk.com/nl



## TDK-Lambda Corporation

Tel: +81-3-6778-1113  
www.jp.lambda.tdk.com



## TDK-Lambda Europe GmbH

Tel: +49 7841 666 0  
tlg.powersolutions@tdk.com  
www.emea.lambda.tdk.com/de



## TDK-Lambda (China) Electronics Co. Ltd.

Tel: +86 21 6485-0777  
tlc.powersolutions@tdk.com  
www.lambda.tdk.com.cn



## Austria Sales Office

Tel: +43 2256 655 84  
tlg.at-powersolutions@tdk.com  
www.emea.lambda.tdk.com/at



## TDK-Lambda Singapore Pte Ltd.

Tel: +65 6251 7211  
tts.marketing@tdk.com  
www.sg.lambda.tdk.com



## Switzerland Sales Office

Tel: +41 44 850 53 53  
tlg.ch-powersolutions@tdk.com  
www.emea.lambda.tdk.com/ch



## TDK India Private Limited, Power Supply Division

Tel: +91 80 4039-0660  
mathew.philip@tdk.com  
www.sg.lambda.tdk.com



## TDK-Lambda Europe GmbH

Tel: Tel. +45 3222 8086  
tlg.dk-powersolutions@tdk.com  
www.emea.lambda.tdk.com/dk

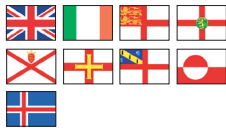

## TDK-Lambda UK Ltd.

Tel: +44 (0) 12 71 85 66 66  
tlu.powersolutions@tdk.com  
www.emea.lambda.tdk.com/uk



## TDK-Lambda Ltd.



Tel: +9 723 902 4333  
tli.powersolutions@tdk.com  
www.emea.lambda.tdk.com/il-en

For Additional Information, please visit  
<https://product.tdk.com/en/power/>



## Looking for pricing, stock, or lifecycle information?

Click below to explore more details on WIN SOURCE:

-  [View PFE500SA-28/T on WIN SOURCE](#)
-  [TDK-Lambda Americas Inc. Information](#)

## Optimize Your Supply Chain with WIN SOURCE Solutions

-  Global Sourcing Solution
-  Obsolete Management
-  Cost Control Management
-  Shortage Management
-  Alternative Solution
-  Excess Inventory Management