

## Product Description

An excellent alternative to traveling wave tube amplifiers, Qorvo’s Spatium™ QPB2040N is a solid state, spatial-combining amplifier with an operating range of 18–40 GHz. With its maximum performance in output power, gain, power added efficiency, and power flatness, this Spatium is the ideal building block for various millimeter-wave subsystems with wide-ranging applications.

Qorvo’s patented and field-proven Spatium combining technology provides unprecedented Solid-State Power Amplifier (SSPA) performance in a rugged, compact size and weight which reduces total cost of ownership compared to alternative technologies. This product offering combines Qorvo’s market leadership in GaN technology and wideband MMIC design along with our high-count combining techniques for a best in class solution to power amplification.

The QPB2040N is equipped with an integrated bias card, which allows for convenience of operation, reducing electrical losses in the bias networks, and weight reduction over using a separate bias card. It provides individualized bias settings for each amplifier blade in the Spatium SSPA as well as drain pulsing up to 1.5 MHz PRF for superior power savings and noise performance.

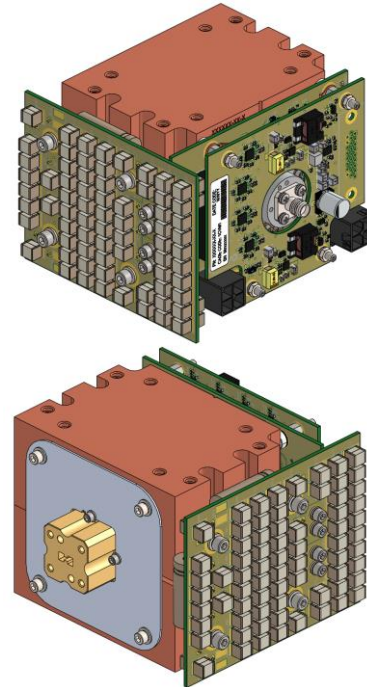

Input (T) and Output (B)

## Functional Block Diagram

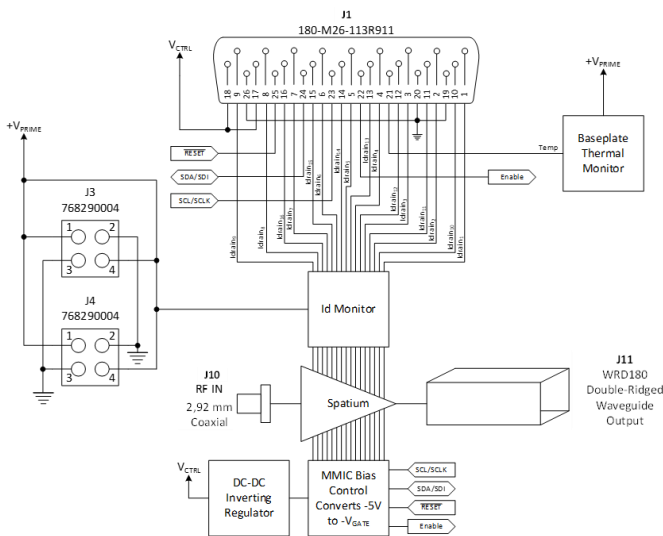

## Product Features

- Frequency Range: 18–40 GHz
- Saturated Output Power: 50.0 dBm ( $P_{IN} = 39$  dBm)
- Large Signal Gain: 11.0 dB ( $P_{IN} = 39$  dBm)
- Solid State MMIC Reliability
- Multi-Element Redundancy
- Instant On (no warm-up)
- Integrated Bias Card

*Performance is typical across frequency. Please reference electrical specification table and data plots for more details.*

## Applications

- TWTA Replacement

## Ordering Information

Part No.	Description
QPB2040N	18–40 GHz Spatium™ Amplifier

## Absolute Maximum Ratings

Parameter	Value / Unit
Prime Power for Spatium SSPA ( $V_{DC}$ ), Max.	22 V
Prime Power for Spatium SSPA ( $V_{DC}$ ), Min.	14 V
Drain Current ( $I_{D\_DRIVE}$ )	80 A
Load VSWR	3:1
Input Power (CW, VSWR 1.5:1, 25 °C)	39 dBm
Operating Temperature*	-40 to +71 °C
Storage Temperature	-40 to +85 °C

Operation of this device outside the parameter ranges given above may cause permanent damage. These are stress ratings only, and functional operation of the device at these conditions is not implied.

\* Refers to outside clamp surface temperature

## Recommended Operating Conditions

Parameter	Value / Unit
Drain Voltage ( $V_D$ ) (operation above 18 V is not recommended)	18 V
Quiescent Drain Current ( $I_{DQ}$ )	40 A
Operating Drain Current ( $I_D$ )	54 A
Operating Temperature*	
CW (full band)	-40 to +55 °C
Pulse (full band), CW (20 – 37 GHz)	-40 to +71 °C

\* Refers to outside clamp max/min surface temperature. 2-sided cooling required (see page 12). CW operation above 37 GHz is limited above  $T_{CLAMP} = +55$  °C due to high channel temperatures, which affects MMIC MTTF.

Electrical specifications are measured at specified test conditions. Specifications are not guaranteed over all recommended operating conditions.

## Electrical Specifications

Parameter	Min	Typ	Max	Units
Frequency	18		40	GHz
Output Power (CW, $P_{IN} = 39$ dBm)		50.0		dBm
Power Gain (CW, $P_{IN} = 39$ dBm)		11		dB
Gain Flatness vs Freq. (CW, $P_{IN} = 39$ dBm)		+1.4 / -1.1		dB
PAE (CW, $P_{IN} = 39$ dBm)		9.8		%
Switching Time ( $PW = 500$ ns, $F = 32$ GHz, $P_{IN} = 39$ dBm)				
ENABLE > 2.5 V to 90% RF (ON)		105		ns
ENABLE < 2.5 V to 10% RF (OFF)		137		ns
Small Signal Gain (S21), CW		16.1		dB
Input Return Loss (S11), CW		18		dB
DC Power (CW, $P_{IN} = 39$ dBm, average)		961		W
Input RF Interface	2.92 mm (F) Coaxial Connector			
Output RF Interface	WRD-180 Double-Ridged Waveguide			
Weight: Amplifier + Bias Card		6.1 (2.77)		lbs. (kg)
Dimensions: Amplifier + Bias Card (L) x (W) x (H)		3.94 x 2.91 x 4.04		inches
		100.0 x 73.9 x 102.6		millimeters

Test conditions unless otherwise noted:  $V_{DC} = 18$  V,  $I_{DQ} = 40$  A, CW,  $T = 25$  °C

## Typical Performance – Large Signal (CW)

Conditions unless otherwise specified:  $V_D = 18\text{ V}$ ,  $I_{DQ} = 40\text{ A}$ ,  $P_{IN} = 39\text{ dBm}$

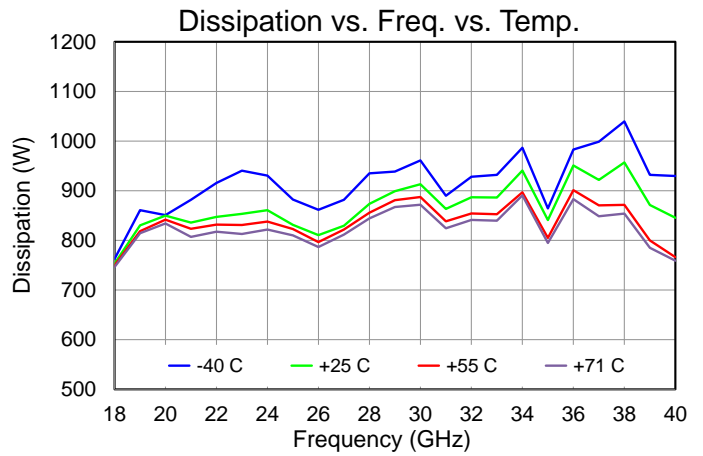
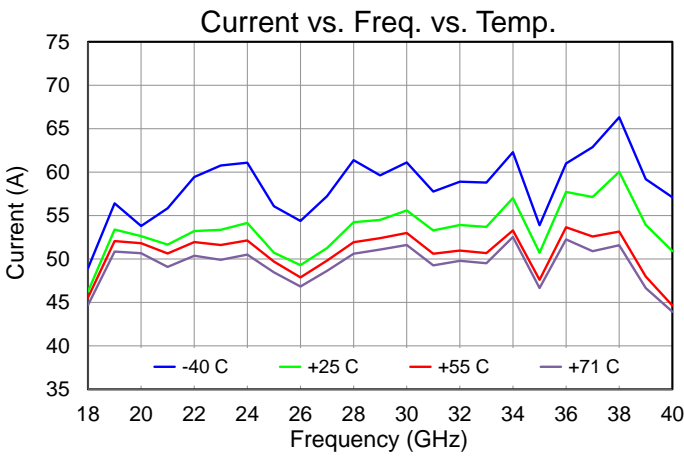
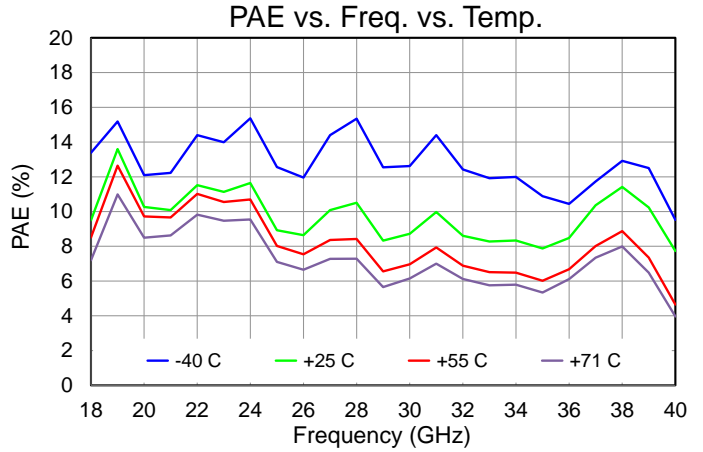
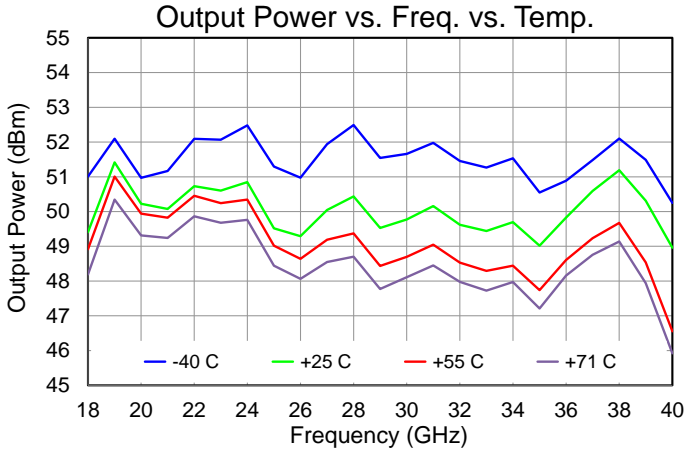

## Typical Performance – Large Signal (CW)

Conditions unless otherwise specified:  $V_D = 18\text{ V}$ ,  $I_{DQ} = 40\text{ A}$ ,  $T = 25\text{ }^\circ\text{C}$

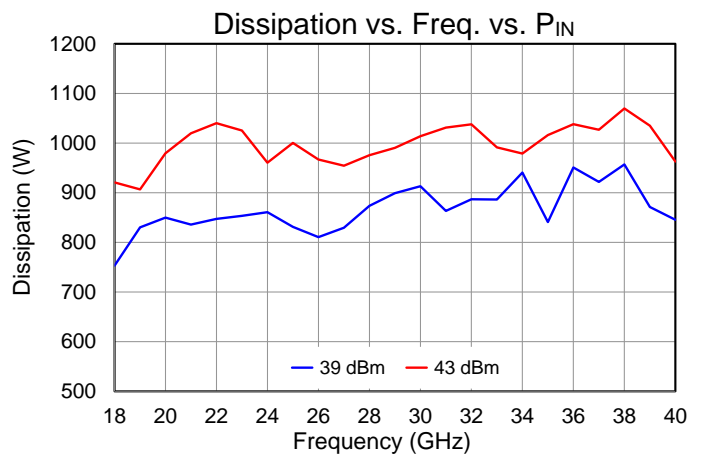
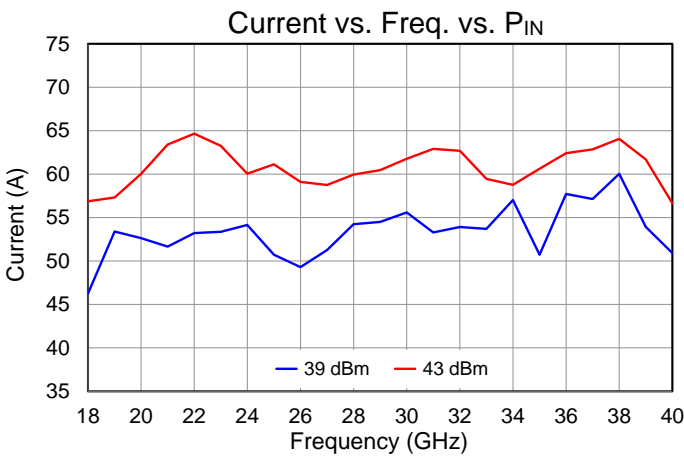
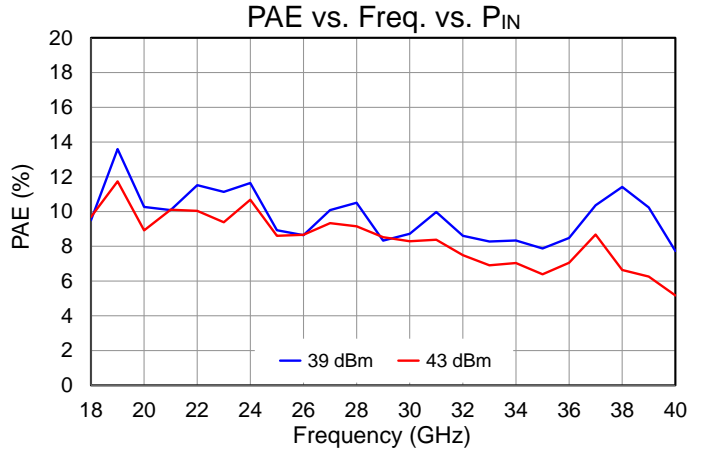
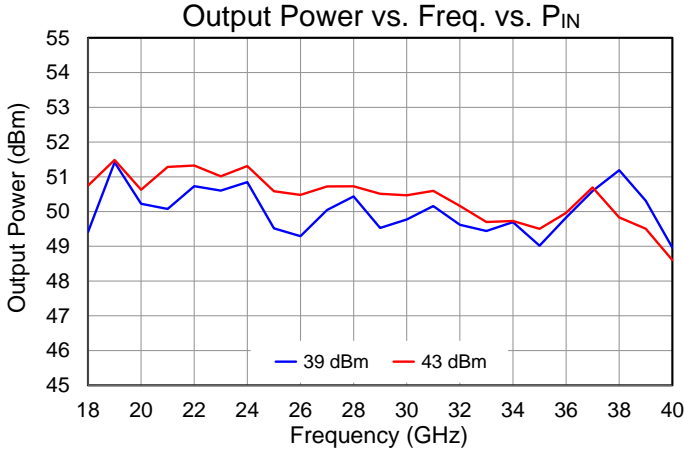

**Typical Performance – Large Signal Drive Up (CW)**

Conditions unless otherwise specified:  $V_D = 18\text{ V}$ ,  $I_{DQ} = 40\text{ A}$ ,  $T = 25\text{ }^\circ\text{C}$ , CW

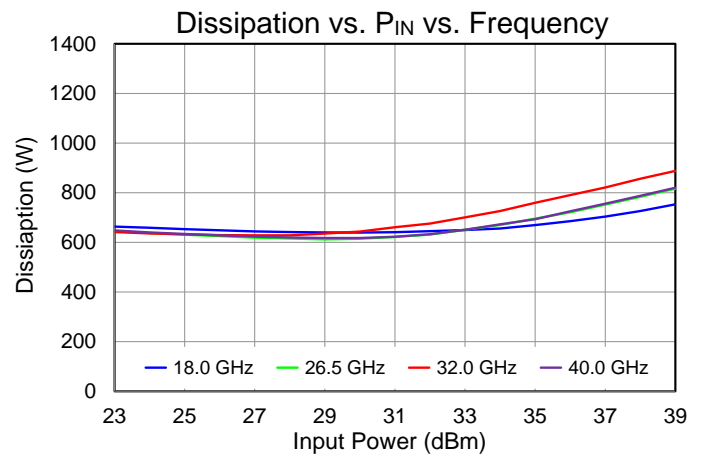
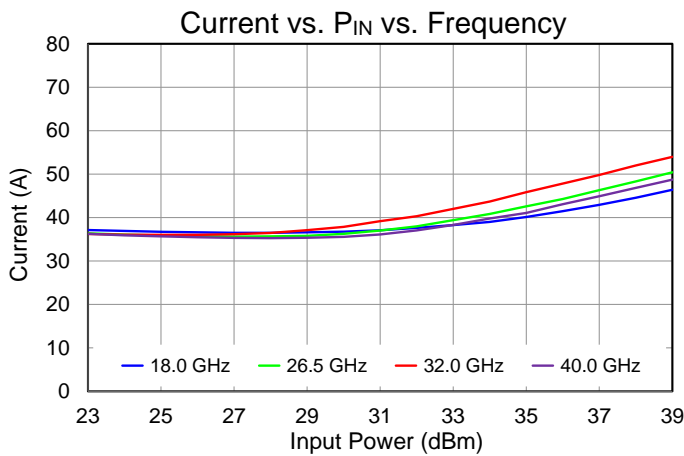
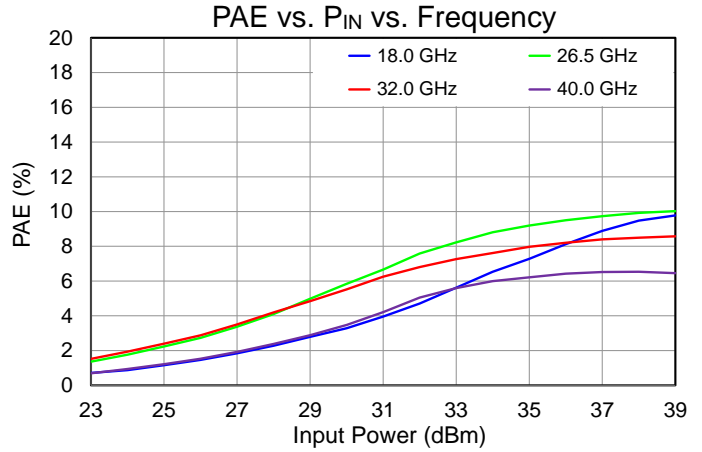
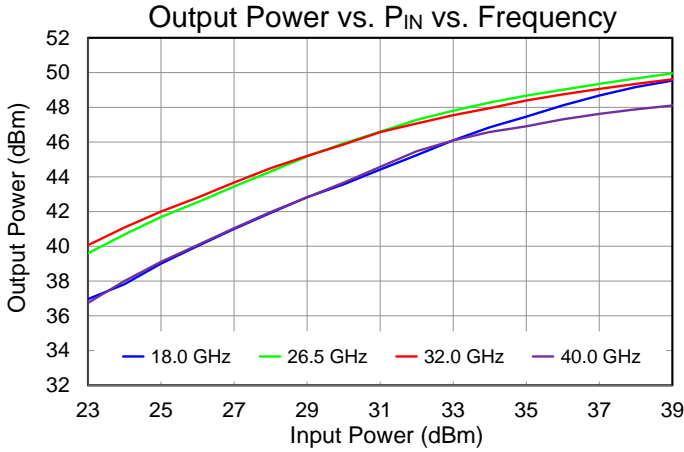

## Typical Performance – Large Signal Drive Up (CW)

Conditions unless otherwise specified:  $V_D = 18\text{ V}$ ,  $I_{DQ} = 40\text{ A}$ , Frequency = 32 GHz

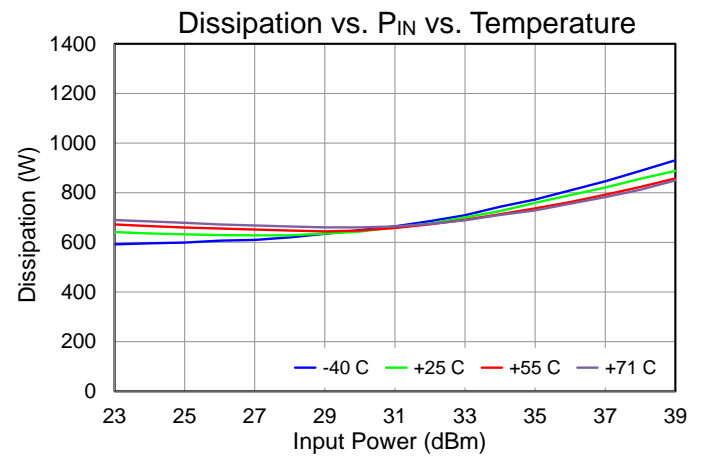
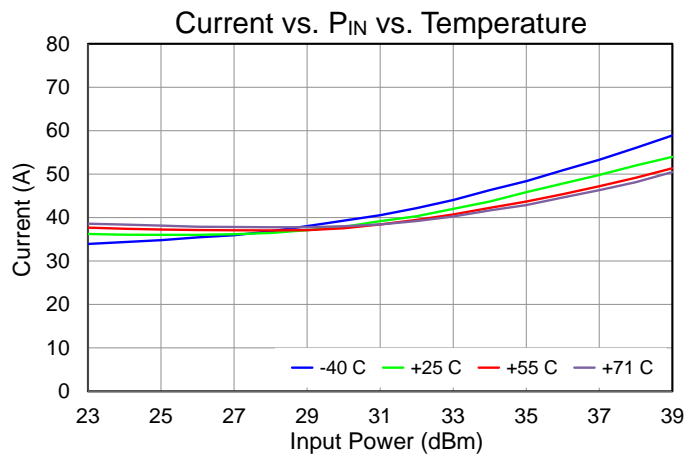
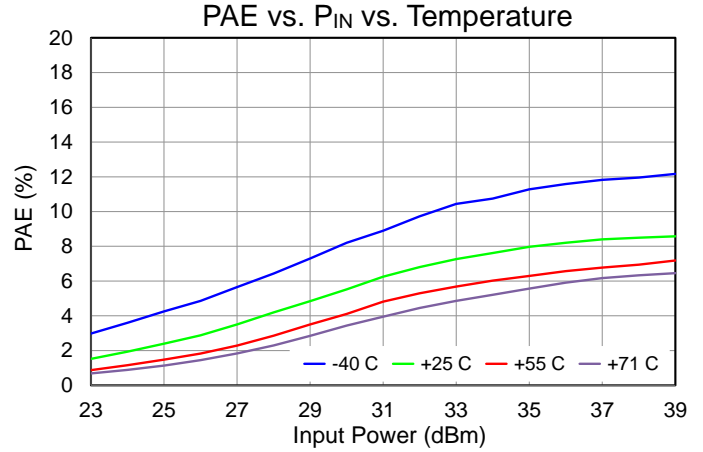
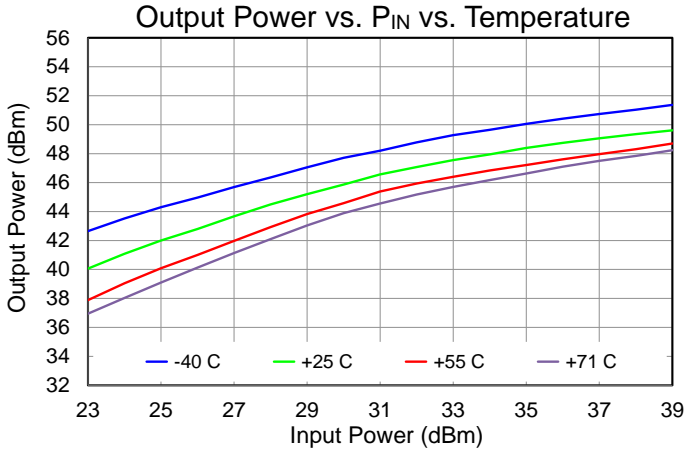

### Typical Performance – Large Signal (Pulse)

Conditions unless otherwise specified:  $V_D = 18\text{ V}$ ,  $I_{DQ} = 40\text{ A}$ ,  $P_{IN} = 39\text{ dBm}$

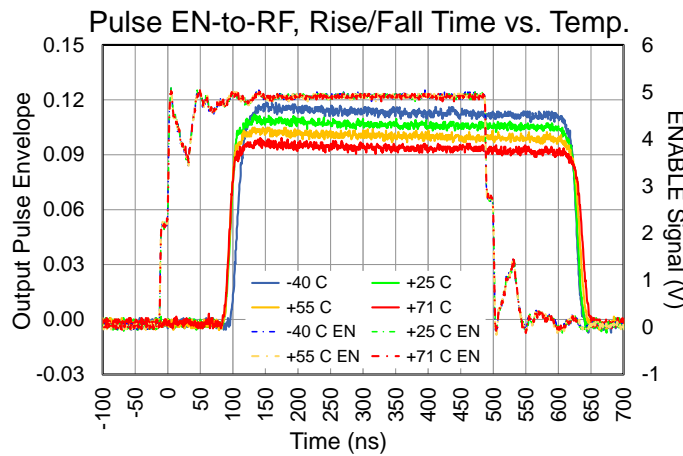
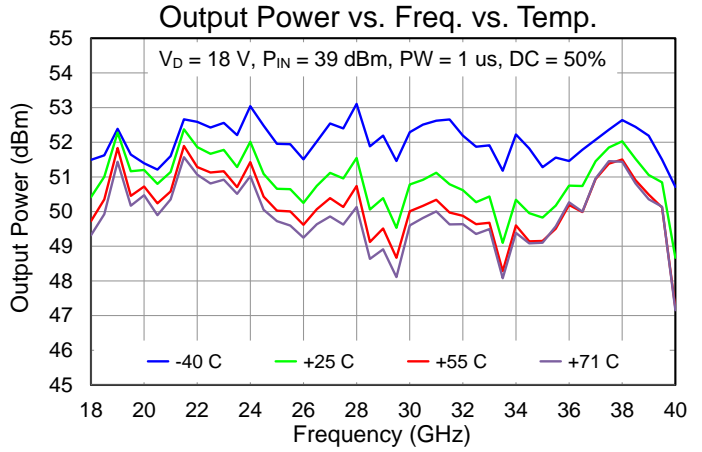
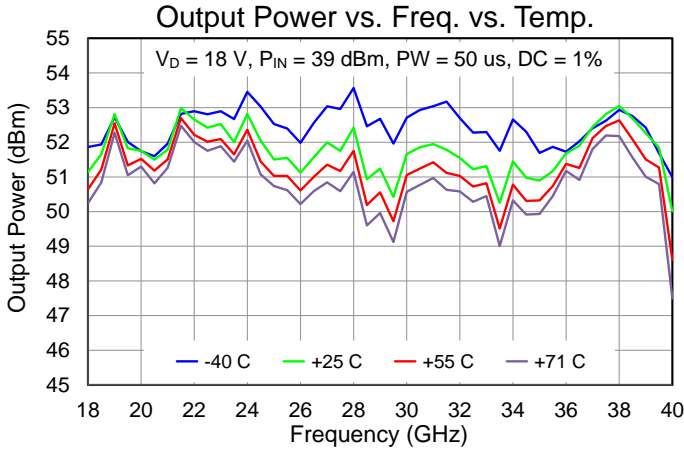

**Typical Performance – Small Signal**

Conditions unless otherwise specified:  $V_D = 18\text{ V}$ ,  $I_{BQ} = 40\text{ A}$ ,  $T = 25\text{ }^\circ\text{C}$ , CW

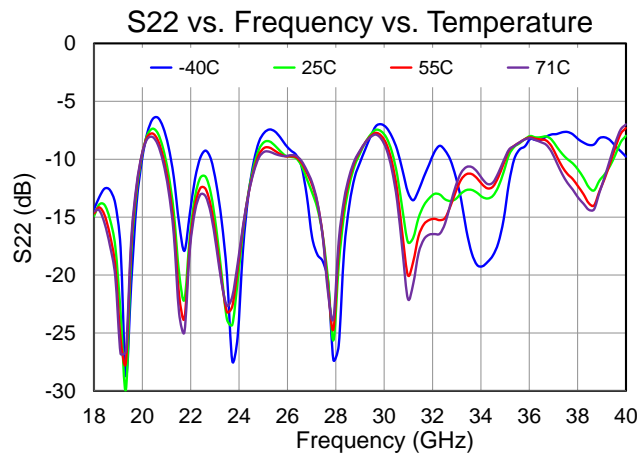
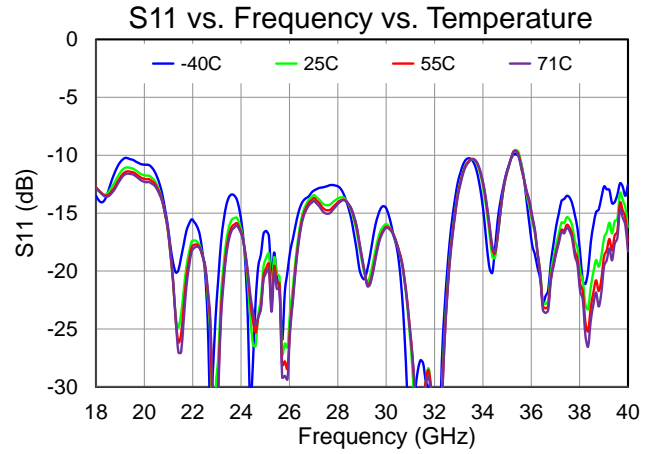
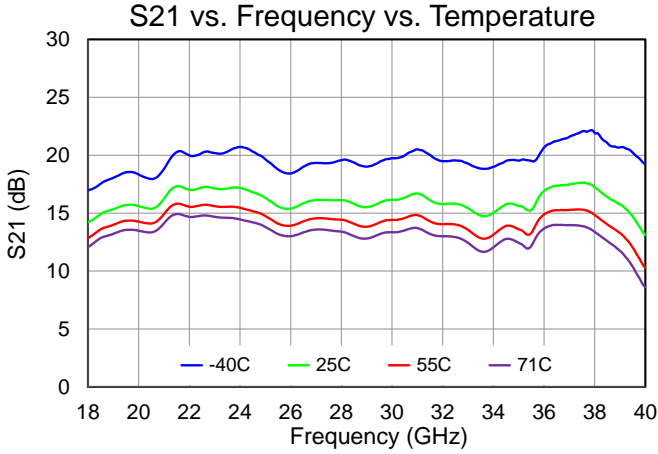

## Reliability Information

Conditions unless otherwise specified:  $V_D = 18\text{ V}$ ,  $I_{DQ} = 40\text{ A}$ ,  $P_{IN} = 39\text{ dBm}$ ,  $P_{DISS} = 59\text{ W/MMIC PA}$

Mean Time Between Failure at $P_{SAT}\text{ CW}$ , $P_{DISS} = 59\text{ W}$			
CLAMP TEMP (°C)	25	55	71
ENVIRONMENT	MTBF (x1000 Hours)		
AUC	118.95	7.49	1.13
GF	372.01	33.96	5.50
GB	1272.54	75.43	11.27

Calculations derived from MIL-HDBK-217F

Operational environments are:

GB – Ground Benign

GF – Ground Fixed

AUC – Airborne Uninhabited Cargo

Failures Per Million Hours at $P_{SAT}\text{ (CW)}$ , $P_{DISS} = 59\text{ W}$			
CLAMP TEMP (°C)	25	55	71
ENVIRONMENT	FPMH		
AUC	8.41	133.58	884.17
GF	2.69	29.45	181.72
GB	0.79	13.26	88.70

## Block Diagram and Description

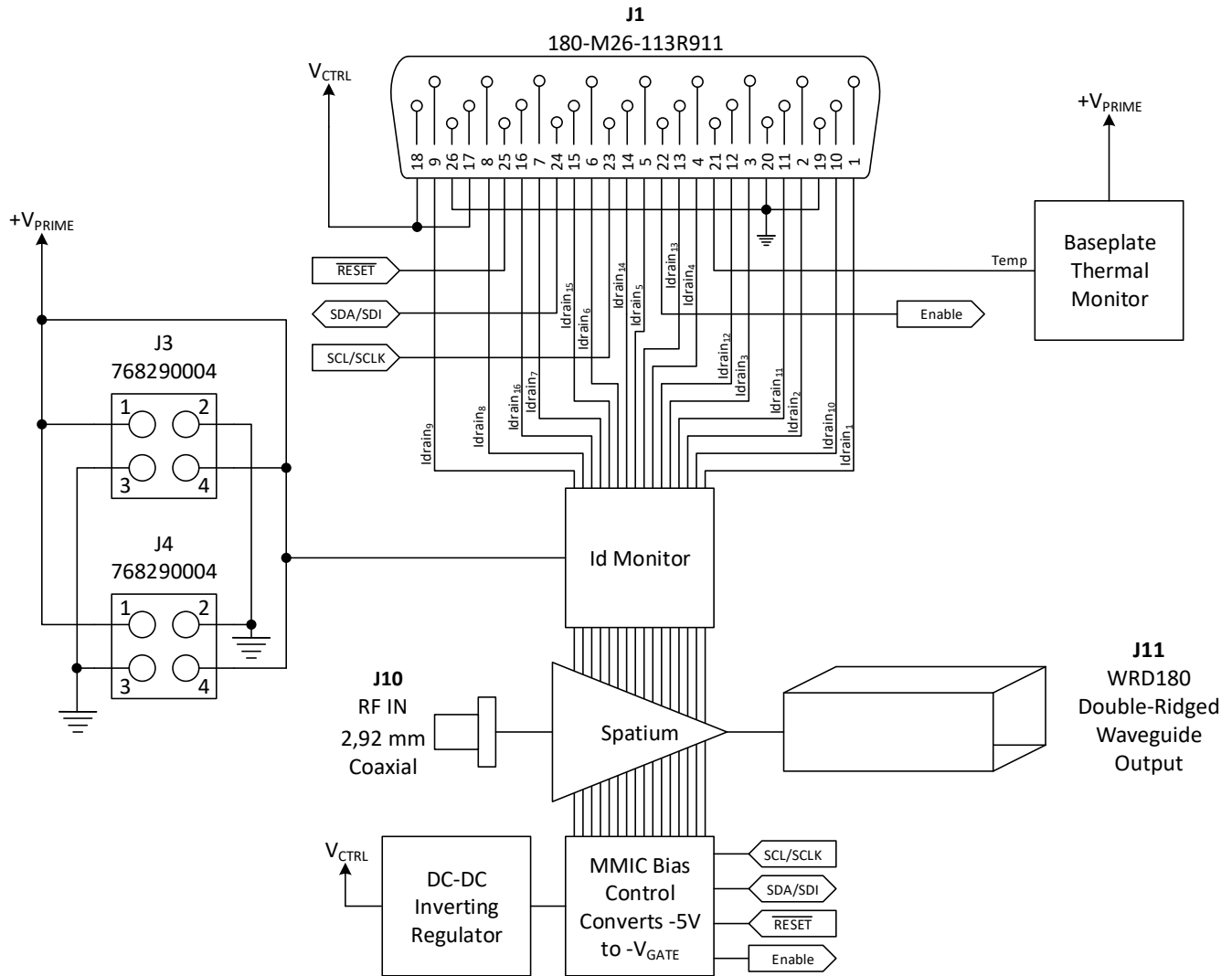

Pin No.	Label	Description
RF In	J10	2.92mm (F) Coaxial RF Input.
RF Out	J11	WRD-180 Double-Ridged Waveguide High Power RF Output
Auxiliary	J1	D-SUB HD 26POS (M), NorComp, 180-M26-113R9
Power	J3, J4	MOLEX, 07682900

**Mechanical Information – Outline Drawing (Spatium™ Unit with Bias Card)**

NOTES: UNLESS OTHERWISE SPECIFIED

△ LABEL LOCATION.



△ SPATIUM REQUIRES 2 SIDED COOLING ON OPPOSITE FACES INDICATED.

△ PRIMARY AND ALTERNATE MOUNTING OPTIONS FOR COOLING OR ATTACHMENT ARE LISTED ON INDICATED FACE.

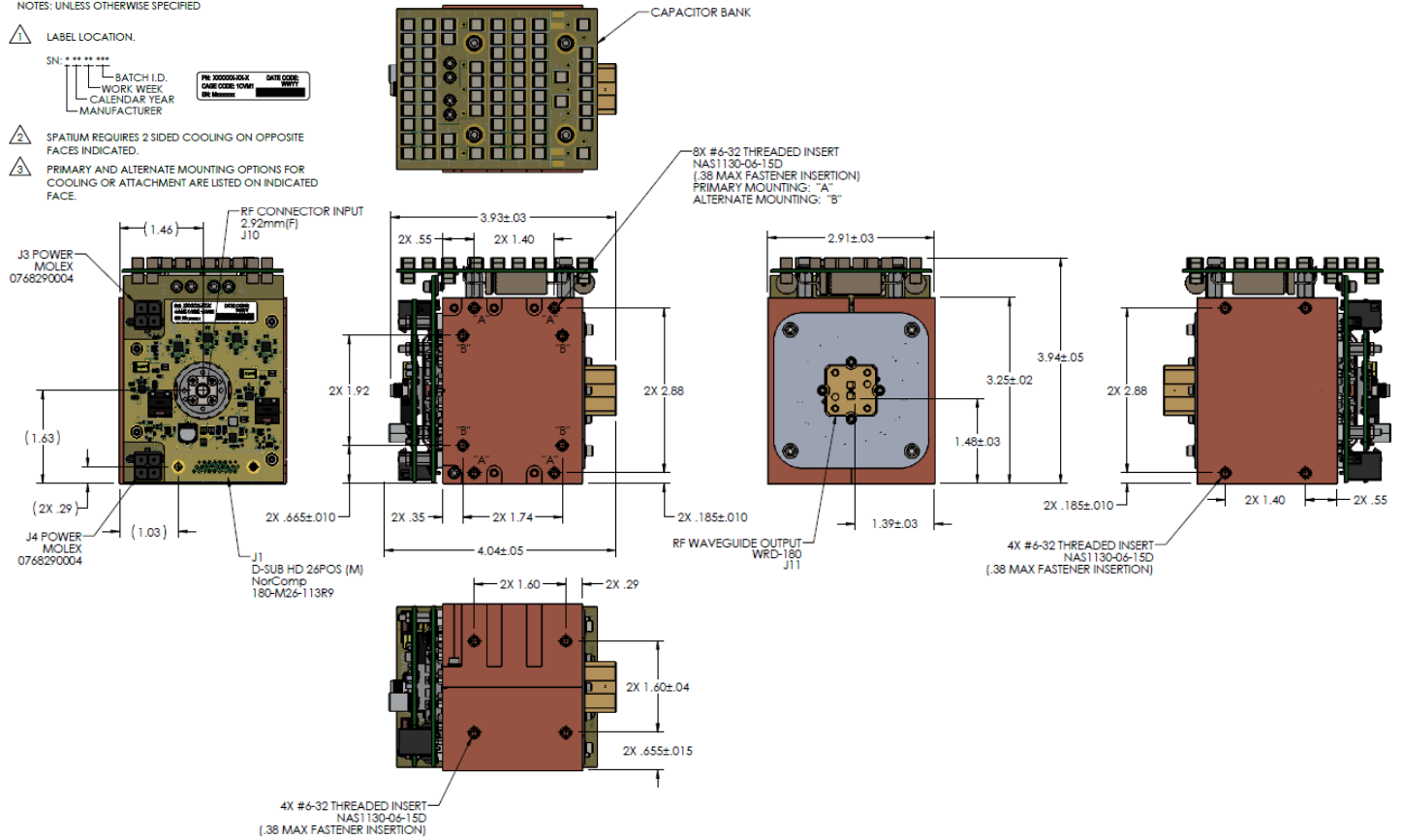

Dimensions are in INCHES

## Mechanical Information – Bias Card Connector Pins

J1 CONNECTOR PIN FUNCTION AND DEFINITION		
PIN NO.	FUNCTION	DESCRIPTION
J1-1	DRAIN 1	Voltage output on this pin follows 0.5V/A times the current flowing through channel 1 of the Spatium
J1-2	DRAIN 2	Voltage output on this pin follows 0.5V/A times the current flowing through channel 2 of the Spatium
J1-3	DRAIN 3	Voltage output on this pin follows 0.5V/A times the current flowing through channel 3 of the Spatium
J1-4	DRAIN 4	Voltage output on this pin follows 0.5V/A times the current flowing through channel 4 of the Spatium
J1-5	DRAIN 5	Voltage output on this pin follows 0.5V/A times the current flowing through channel 5 of the Spatium
J1-6	DRAIN 6	Voltage output on this pin follows 0.5V/A times the current flowing through channel 6 of the Spatium
J1-7	DRAIN 7	Voltage output on this pin follows 0.5V/A times the current flowing through channel 7 of the Spatium
J1-8	DRAIN 8	Voltage output on this pin follows 0.5V/A times the current flowing through channel 8 of the Spatium
J1-9	DRAIN 9	Voltage output on this pin follows 0.5V/A times the current flowing through channel 9 of the Spatium
J1-10	DRAIN 10	Voltage output on this pin follows 0.5V/A times the current flowing through channel 10 of the Spatium
J1-11	DRAIN 11	Voltage output on this pin follows 0.5V/A times the current flowing through channel 11 of the Spatium
J1-12	DRAIN 12	Voltage output on this pin follows 0.5V/A times the current flowing through channel 12 of the Spatium
J1-13	DRAIN 13	Voltage output on this pin follows 0.5V/A times the current flowing through channel 13 of the Spatium
J1-14	DRAIN 14	Voltage output on this pin follows 0.5V/A times the current flowing through channel 14 of the Spatium
J1-15	DRAIN 15	Voltage output on this pin follows 0.5V/A times the current flowing through channel 15 of the Spatium
J1-16	DRAIN 16	Voltage output on this pin follows 0.5V/A times the current flowing through channel 16 of the Spatium
J1-17	5V0	5V internally generated reference voltage
J1-18	5V0	5V internally generated reference voltage
J1-19	GND	Connect to logic ground
J1-20	GND	Connect to logic ground
J1-21	VTEMP	Connects to Texas Instruments LMT87 temperature sensor output
J1-22	ENABLE	5V logic command bit to turn on/off the drain voltage leading to each channel of the Spatium. 0V puts the unit into a low-power state while 5V will allow normal operation. In the absence of an external logic signal (open), the amplifier will power on with the application of the supply voltage.
J1-23	SCL	I2C bus used to program amplifier for operation. Please contact Qorvo applications engineering for further information.
J1-24	SDA	I2C bus used to program amplifier for operation. Please contact Qorvo applications engineering for further information.
J1-25	RESET	I2C bus used to program amplifier for operation. Please contact Qorvo applications engineering for further information.
J1-26	GND	Connect to logic ground.

J1-1 through J1-16 can be used for diagnostics / status of MMIC; otherwise, leave open.

J1-17 and J1-18 can be used to supply up to 100 mA of current if required. Otherwise, leave open. Do not apply a voltage to these pins.

J1-21 can be used to monitor the reference temperature of the Spatium. For the relationship between the sensor output voltage and temperature, please see the LMT87 datasheet.

<https://www.ti.com/lit/ds/symlink/lmt87.pdf>

Mechanical Information – Location Drawing for Heat Sinks / Cold Plates

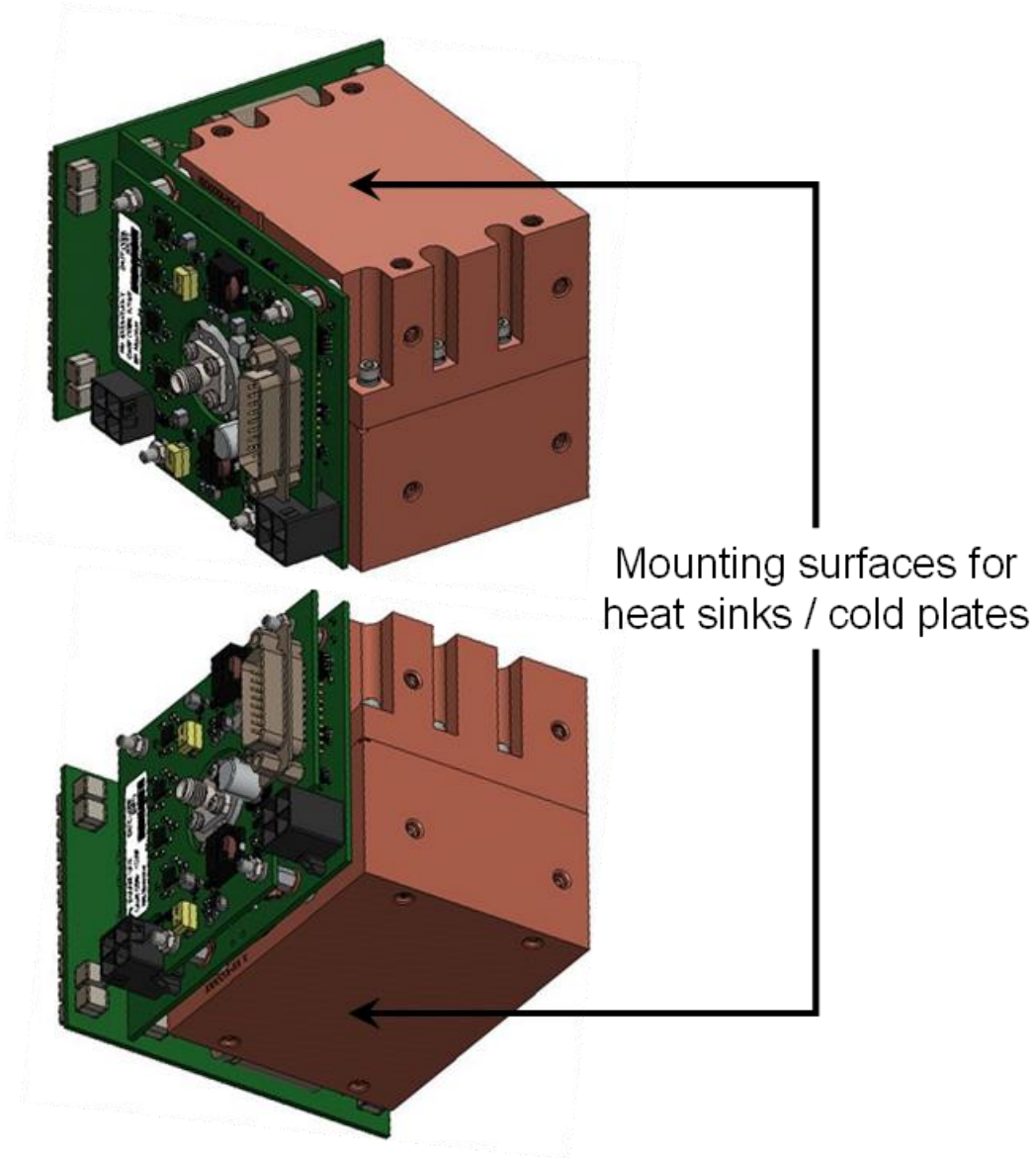

## Handling Precautions

---



Caution!  
ESD-Sensitive Device

RF VOLTAGE HAZARD: Contact with RF fields at the output connector can cause burns or electric shock. High levels of RF/Microwave energy may be present when the unit is operating.

---

HIGH DC CURRENT HAZARD: High levels of DC current are present when the unit is operating.

## Contact Information

---

For the latest specifications, additional product information, worldwide sales and distribution locations:

Web: [www.qorvo.com](http://www.qorvo.com)

Tel: 1-844-890-8163

Email: [customer.support@qorvo.com](mailto:customer.support@qorvo.com)

## Important Notice

---

The information contained herein is believed to be reliable; however, Qorvo makes no warranties regarding the information contained herein and assumes no responsibility or liability whatsoever for the use of the information contained herein. All information contained herein is subject to change without notice. Customers should obtain and verify the latest relevant information before placing orders for Qorvo products. The information contained herein or any use of such information does not grant, explicitly or implicitly, to any party any patent rights, licenses, or any other intellectual property rights, whether with regard to such information itself or anything described by such information. **THIS INFORMATION DOES NOT CONSTITUTE A WARRANTY WITH RESPECT TO THE PRODUCTS DESCRIBED HEREIN, AND QORVO HEREBY DISCLAIMS ANY AND ALL WARRANTIES WITH RESPECT TO SUCH PRODUCTS WHETHER EXPRESS OR IMPLIED BY LAW, COURSE OF DEALING, COURSE OF PERFORMANCE, USAGE OF TRADE OR OTHERWISE, INCLUDING THE IMPLIED WARRANTIES OF MERCHANTABILITY AND FITNESS FOR A PARTICULAR PURPOSE.**

Without limiting the generality of the foregoing, Qorvo products are not warranted or authorized for use as critical components in medical, life-saving, or life-sustaining applications, or other applications where a failure would reasonably be expected to cause severe personal injury or death.

© 2022 Qorvo US, Inc. All rights reserved. This document is subject to copyright laws in various jurisdictions worldwide and may not be reproduced or distributed, in whole or in part, without the express written consent of Qorvo US, Inc.

## Looking for pricing, stock, or lifecycle information?

Click below to explore more details on WIN SOURCE:

 [View QPB2040N on WIN SOURCE](#)

 [Qorvo US Inc. Information](#)

## Optimize Your Supply Chain with WIN SOURCE Solutions

-  Global Sourcing Solution
-  Obsolete Management
-  Cost Control Management
-  Shortage Management
-  Alternative Solution
-  Excess Inventory Management