

## Product Description

An excellent alternative to traveling wave tube amplifiers, Qorvo’s Spatium™ QPB0220N is a solid state, spatial combining amplifier with an operating range of 2–18 GHz. With its maximum performance in output power, gain, power added efficiency, and frequency range, this Spatium is the ideal building block for microwave subsystems with wide-ranging applications.

Qorvo’s patented and field-proven Spatium combining technology provides unprecedented Solid-State Power Amplifier (SSPA) performance in a rugged, compact size and weight which reduces total cost of ownership compared to alternative technologies. This product offering combines Qorvo’s market leadership in GaN technology and MMIC design along with our high-count combining techniques for a best in class solution to power amplification.

The QPB0220N is equipped with an integrated bias card, which allows for convenience of operation, reducing electrical losses in the bias networks, and weight reduction over using a separate bias card. It provides individualized bias settings for each amplifier blade in the Spatium SSPA as well as drain pulsing up to 1 MHz PRF for superior power savings and noise performance.

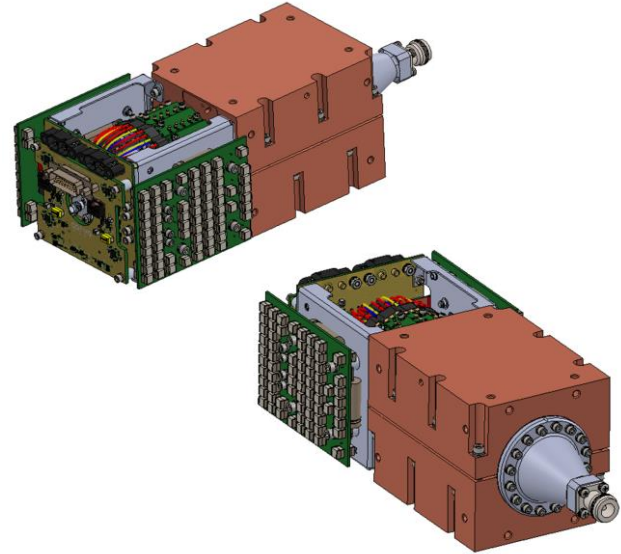

Input (T) and Output (B)

## Functional Block Diagram

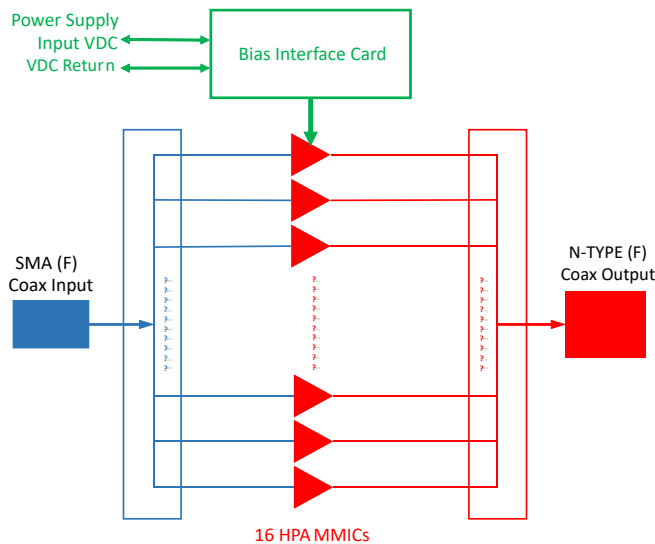

## Product Features

- Frequency Range: 2–18 GHz
- Saturated Output Power: 53.4 dBm ( $P_{IN} = 43$  dBm)
- Large Signal Gain: 10.4 dB ( $P_{IN} = 43$  dBm)
- Solid State MMIC Reliability
- Multi-Element Redundancy
- Instant On (no warm-up)
- Integrated Bias Card

*Performance is typical across frequency. Please reference electrical specification table and data plots for more details.*

## Applications

- TWTA Replacement

## Ordering Information

Part No.	Description
QPB0220N	2–18 GHz Spatium™ Amplifier

## Absolute Maximum Ratings

Parameter <sup>1</sup>	Min Value	Max Value	Units
Prime Power Supply (V <sub>D</sub> ) <sup>2</sup>	-	20	V
Drain Current	-	85	A
Load VSWR	-	3:1	N.A.
Input Power	-	49	dBm
Storage Temperature	-55	85	°C

- 1 Operation of this device outside the parameter ranges given above may cause permanent damage. These are stress ratings only, and functional operation of the device at these conditions is not implied. Extended application of Absolute Maximum Rating conditions may reduce device reliability.
- 2 Rating for thermal reliability.

## Recommended Operating Conditions

Parameter	Min	Typ	Max	Units
Drain Voltage (V <sub>D</sub> , also named V_SUPPLY)		18		V
Quiescent Current (Small Signal Applications)		54		A
Operating Current		See data plots		A
Operating Temperature <sup>1</sup>	-40		71	°C
DC Pulse Width <sup>2</sup>	500			nS

1. Refers to outside clamp surface temperature, 2 - sided cooling required.
2. Unit can be DC or RF pulsed, this limit is for DC pulsing only



## Electrical Specifications

Parameter <sup>1</sup>	Min	Typ	Max	Units
Frequency	2		18	GHz
CW Saturated Power ( $P_{IN} = 43$ dBm)		53.4		dBm
CW Power-Added Efficiency ( $P_{IN} = 43$ dBm)		19.5		%
CW Power Gain ( $P_{IN} = 43$ dBm)		10.4		dB
Pulse Saturated Power ( $P_{IN} = 43$ dBm) <sup>2</sup>		54		dBm
Pulse Power-Added Efficiency ( $P_{IN} = 43$ dBm) <sup>2</sup>		20		%
Pulse Power Gain ( $P_{IN} = 43$ dBm) <sup>2</sup>		11.0		dB
Small Signal Gain		16		dB
Input Return Loss		16		dB
Switching Time, RF Pulsing			30	nS
DC Pulsing, System Rise Time, Enable to 90% RF ON		142	200	nS
DC Pulsing, System Fall Time, Enable to 10% RF OFF		132	200	nS
Second Harmonic, CW (In band, $P_{IN} = 43$ dBm)		-28		dBc
Third Harmonic, CW (In band, $P_{IN} = 43$ dBm)		-14		dBc
Input RF Interface	SMA (F)			
Output RF Interface	Type N (F)			
Weight: Amp + Bias Card	16.5 (7.48)			lbs. (kg)
Weight: Amp + Bias Card + One Capacitor Bank	17.0 (7.71)			lbs. (kg)
Weight: Amp + Bias Card + Two Capacitor Banks	17.5 (7.94)			lbs. (kg)
Dimensions: Amp + Bias Card (L) x (W) x (H)	11.33 x 3.4 x 3.4 (287.8 x 86.4 x 86.4)			inch (mm)
Dimension: Amp + Bias Card + One Capacitor Bank	11.33 x 4.1 x 3.4 (287.8 x 104.1 x 86.4)			inch (mm)
Dimension: Amp + Bias Card + Two Capacitor Banks	11.33 x 4.8 x 3.4 (287.8 x 121.9 x 86.4)			inch (mm)

- 1 Electrical specifications are measured at specified or recommended test conditions as shown in Nominal Operating Condition table. Specifications are not guaranteed over all recommended operating conditions.
- 2 Tested with DC pulsing.

**Typical Performance – Large Signal (CW)**

Conditions unless otherwise specified:  $V_D = 18\text{ V}$ ,  $P_{IN} = 43\text{ dBm}$ ,  $T_{CLAMP} = 25\text{ }^\circ\text{C}$

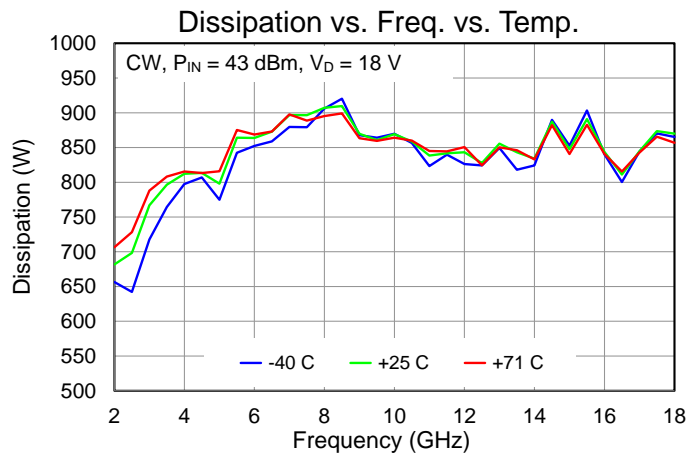
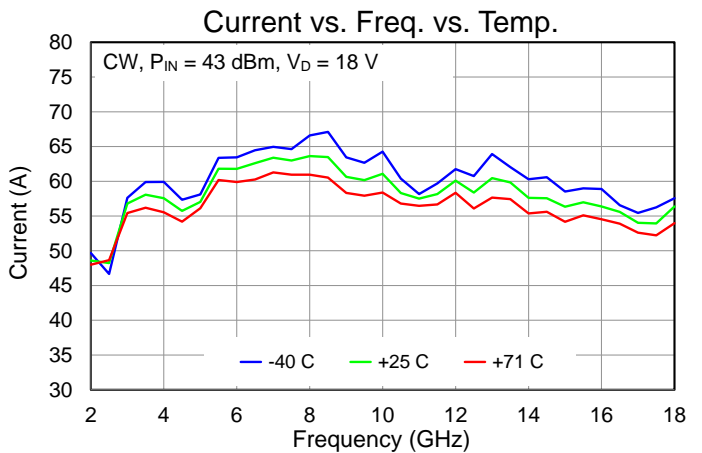
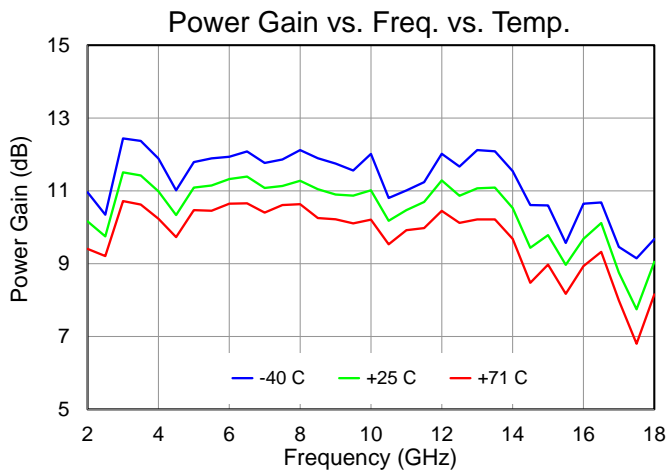
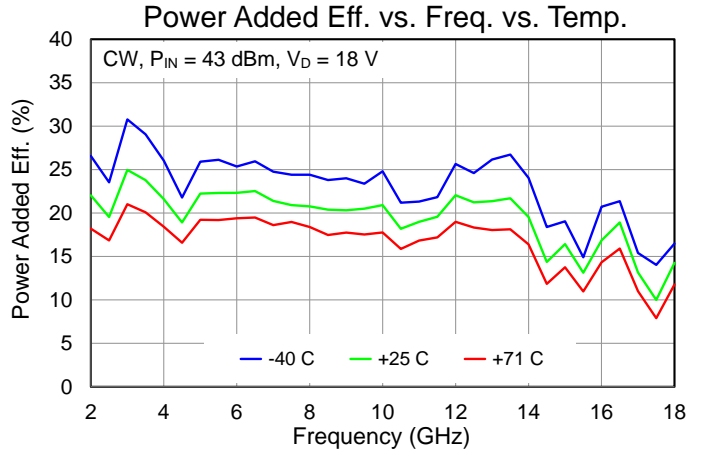
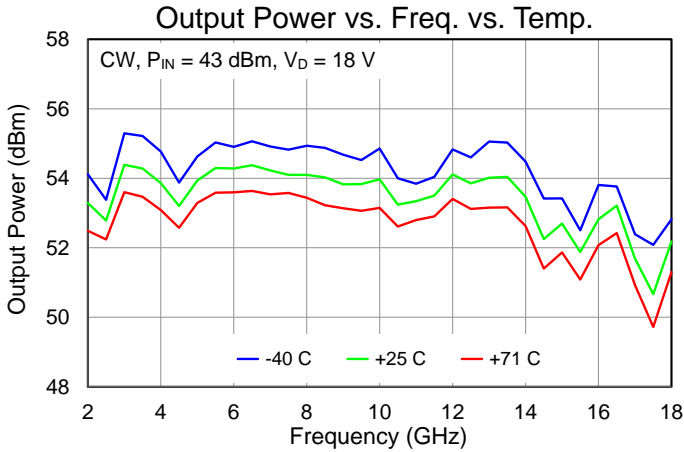

## Typical Performance – Large Signal (CW)

Conditions unless otherwise specified:  $V_D = 18\text{ V}$ ,  $T_{CLAMP} = 25\text{ }^\circ\text{C}$

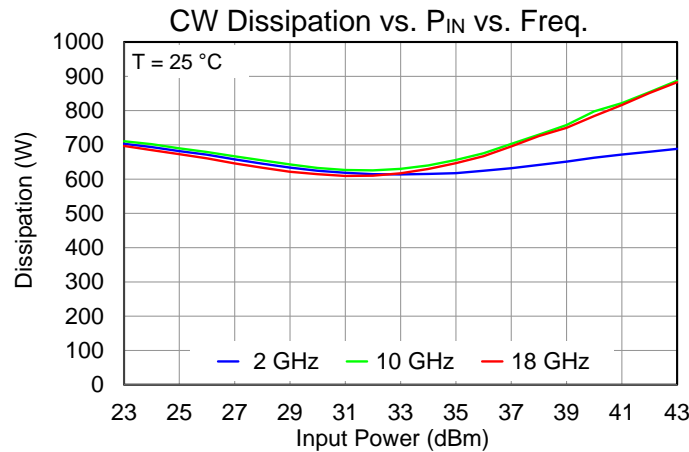
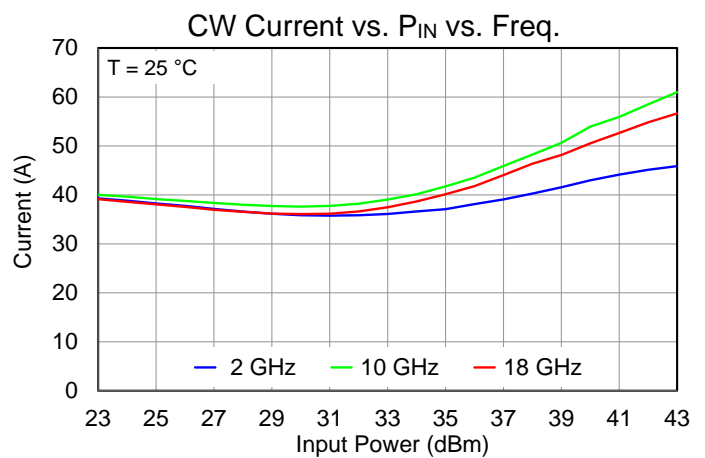
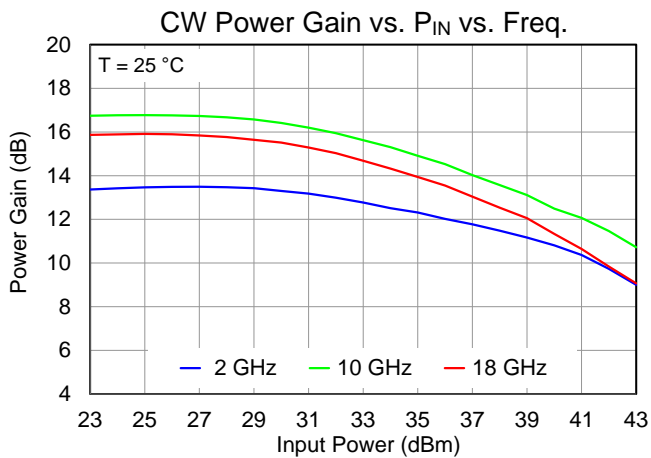
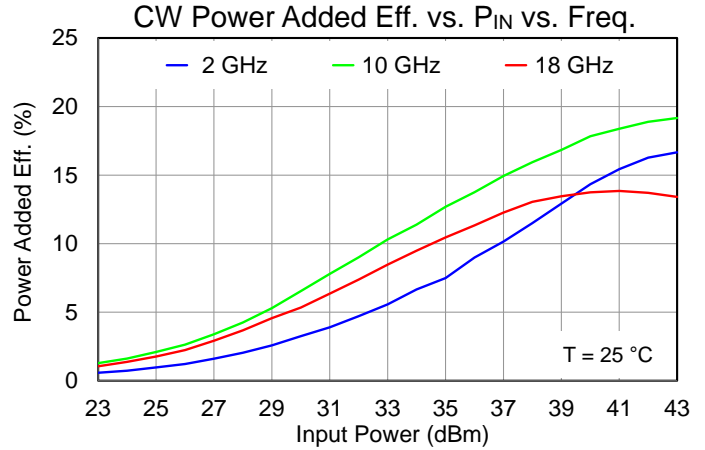
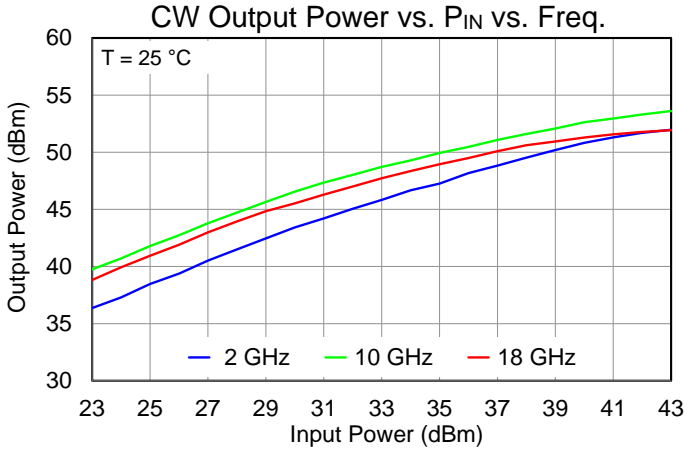

## Typical Performance – Large Signal (CW)

Conditions unless otherwise specified:  $V_D = 18\text{ V}$ ,  $T_{CLAMP} = 25\text{ }^\circ\text{C}$

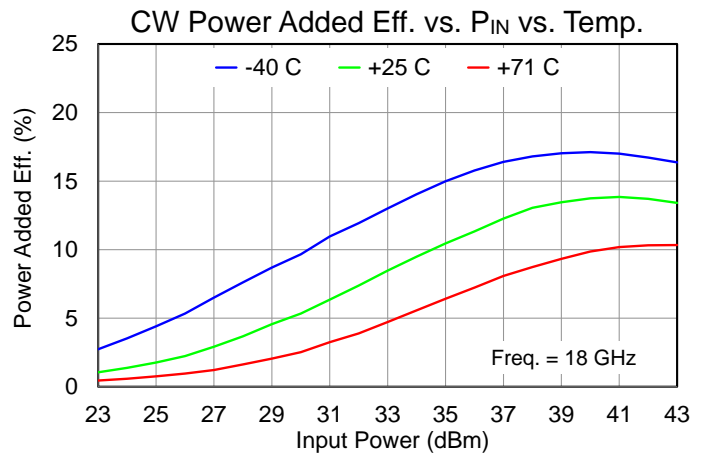
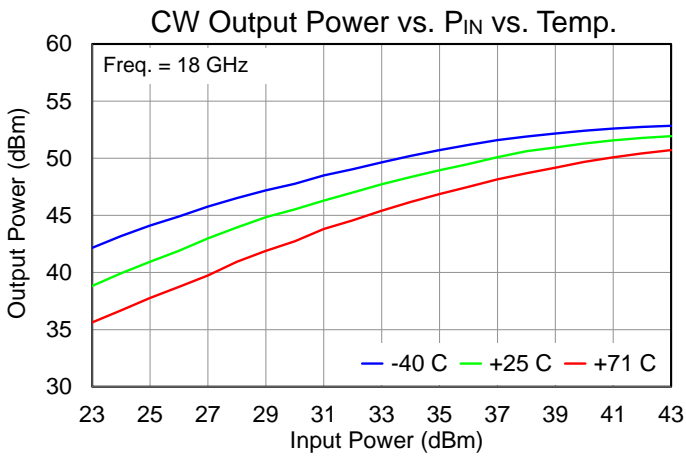
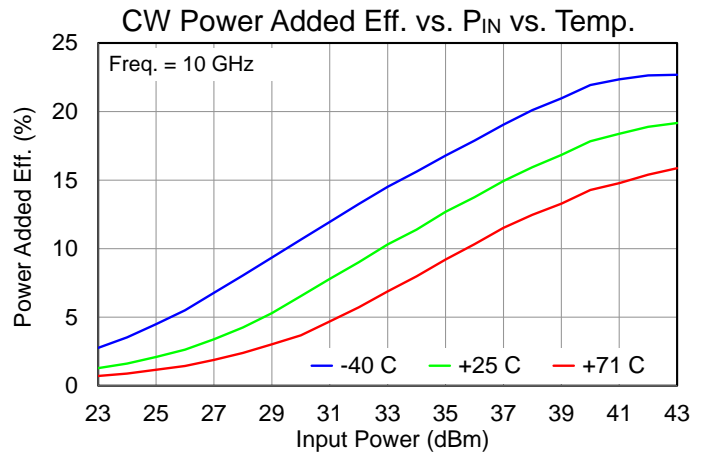
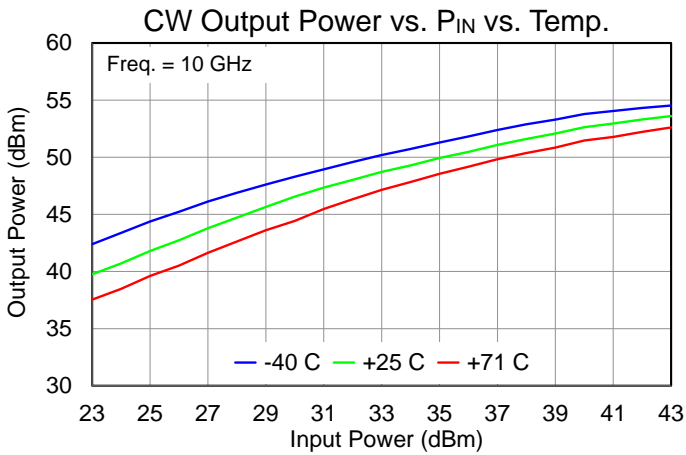
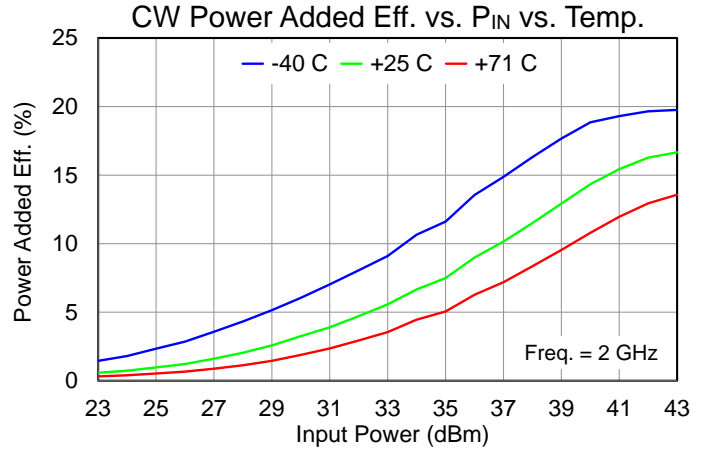
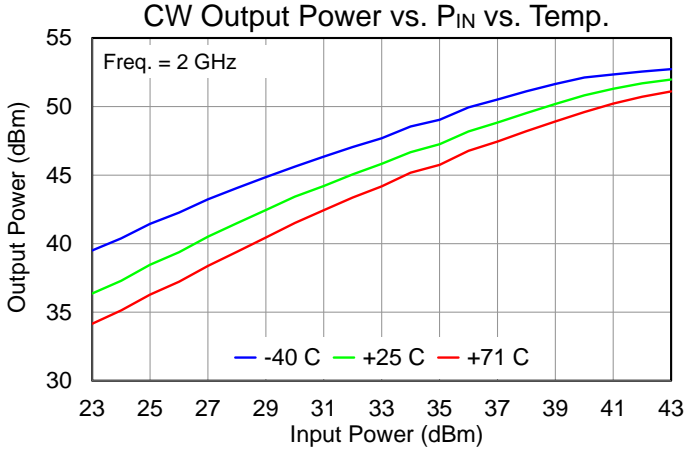

**Typical Performance – Large Signal (Pulsed)**

Conditions unless otherwise specified:  $V_D = 18\text{ V}$ ,  $P_{IN} = 43\text{ dBm}$ ,  $PW = 500\text{ ns}$ ,  $DC = 50\%$ ,  $T_{CLAMP} = 25\text{ }^\circ\text{C}$

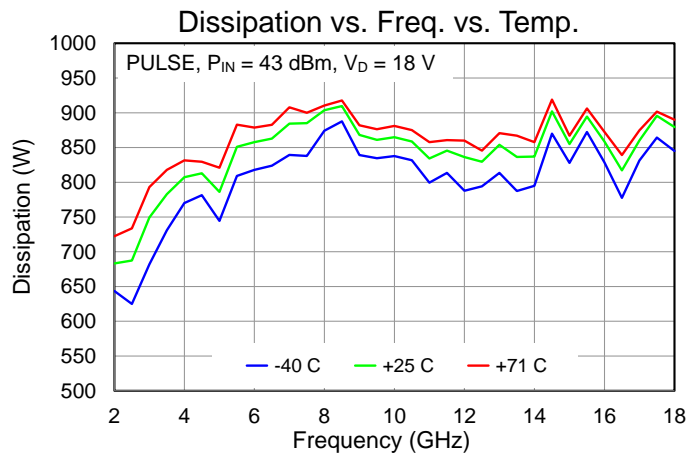
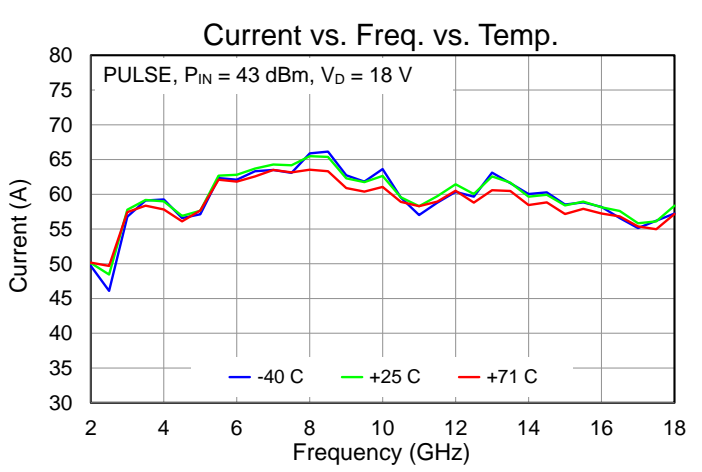
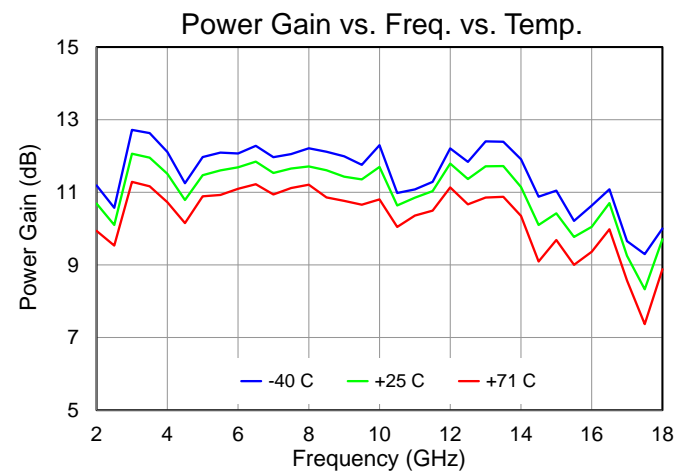
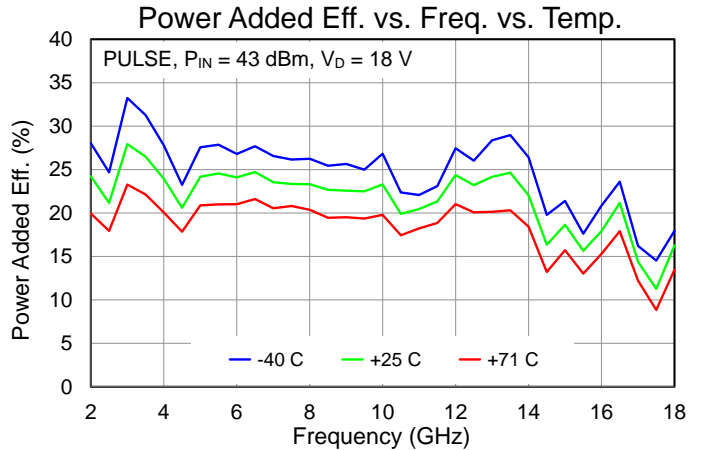
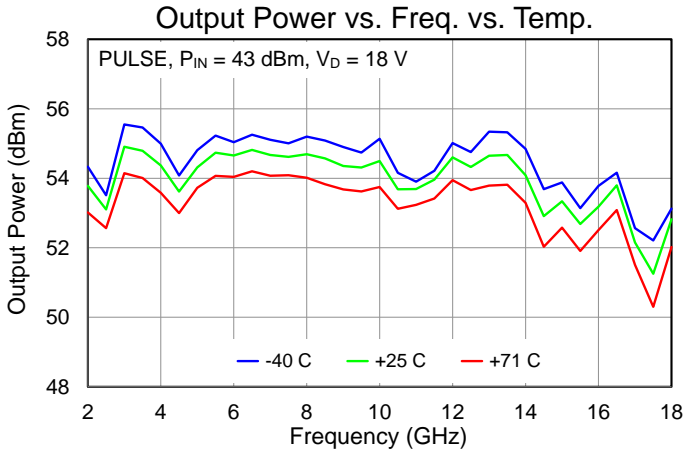

## Typical Performance – Large Signal (Pulsed)

Conditions unless otherwise specified:  $V_D = 18\text{ V}$ ,  $PW = 500\text{ ns}$ ,  $DC = 50\%$ ,  $T_{CLAMP} = 25\text{ }^\circ\text{C}$

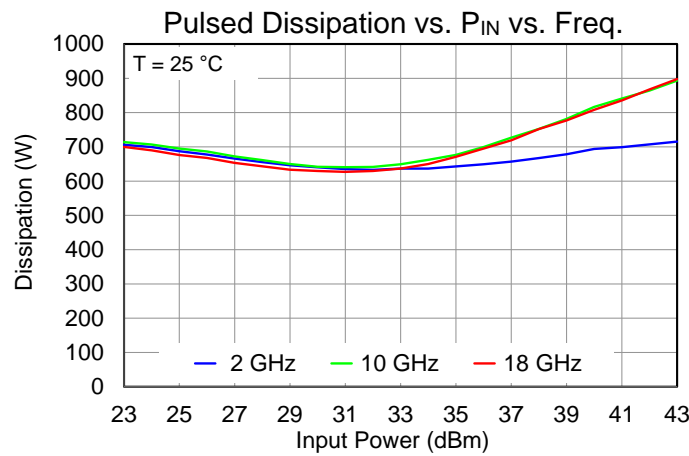
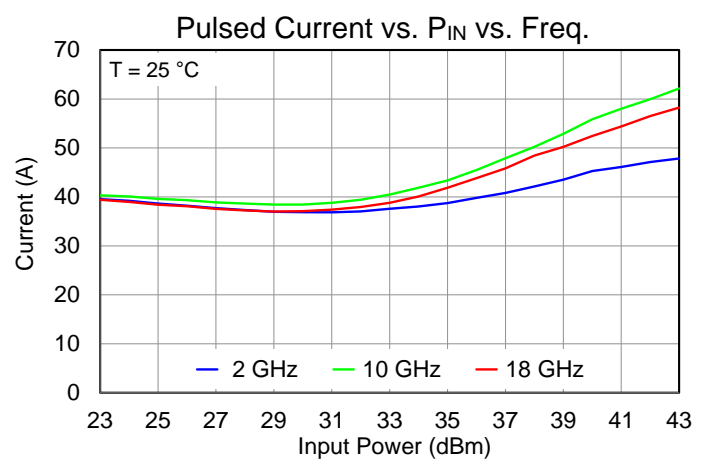
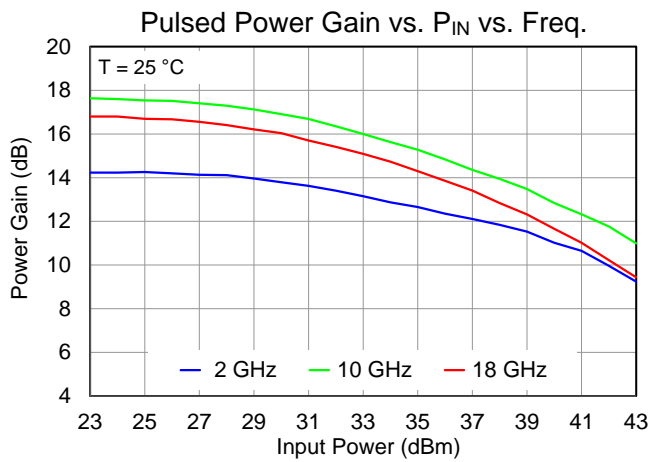
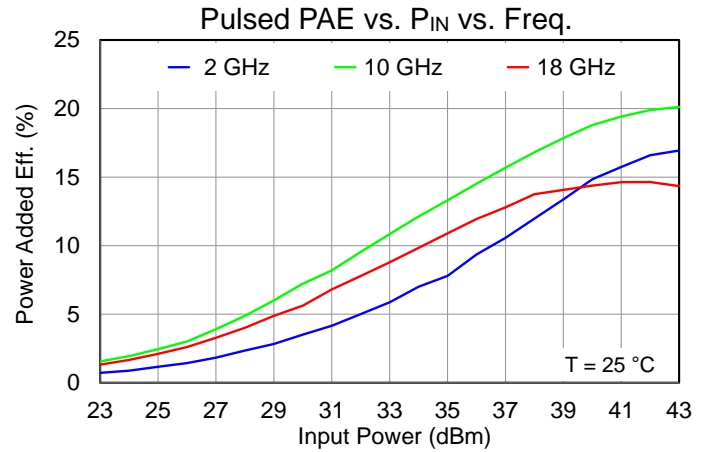
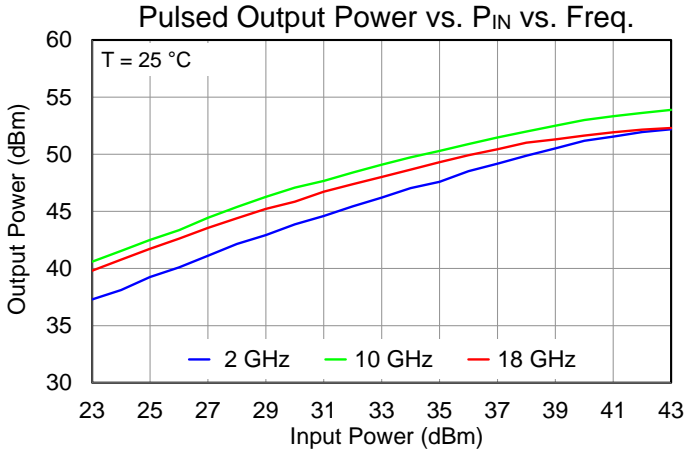

### Typical Performance – Large Signal (Pulsed)

Conditions unless otherwise specified:  $V_D = 18\text{ V}$ ,  $PW = 500\text{ ns}$ ,  $DC = 50\%$ ,  $T_{CLAMP} = 25\text{ }^\circ\text{C}$

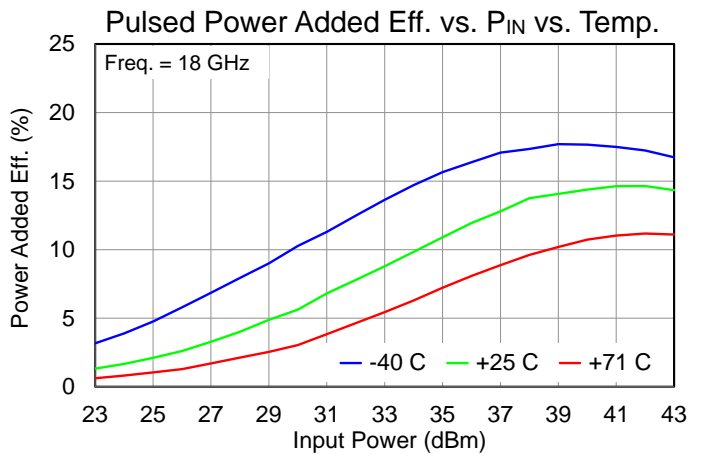
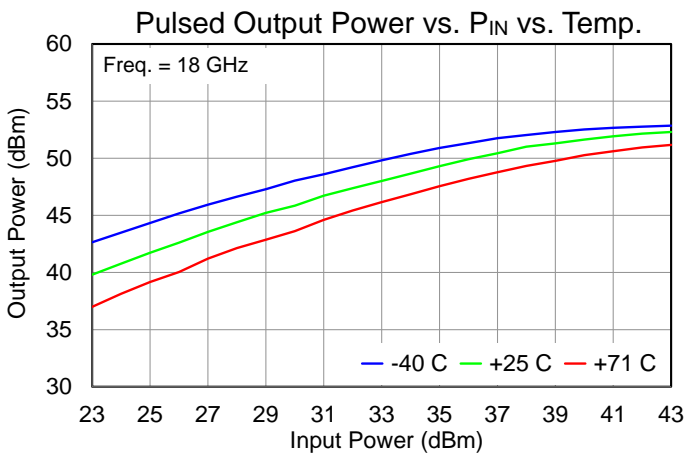
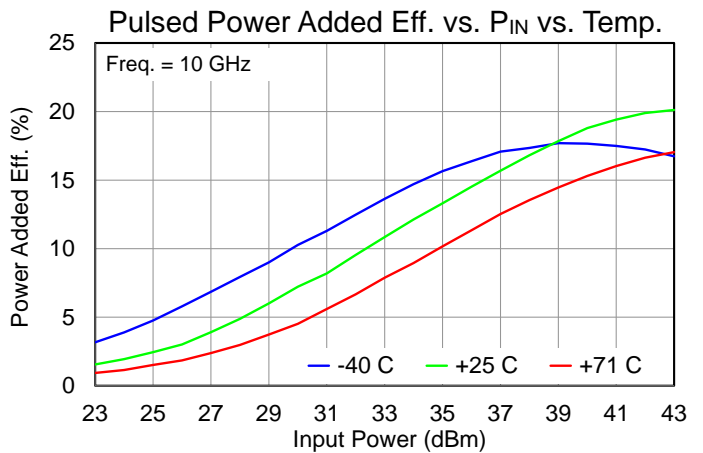
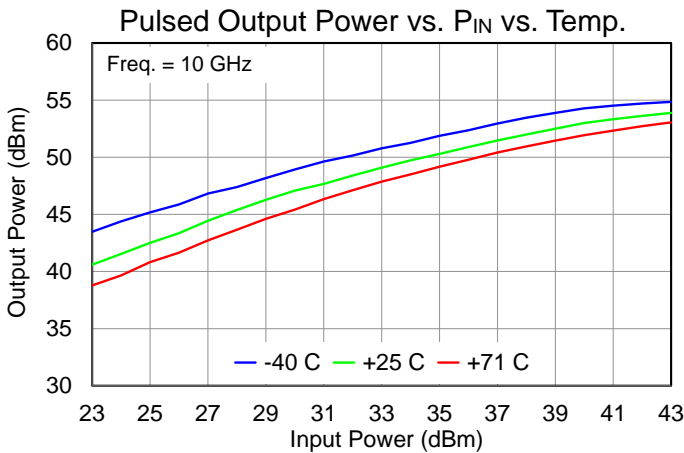
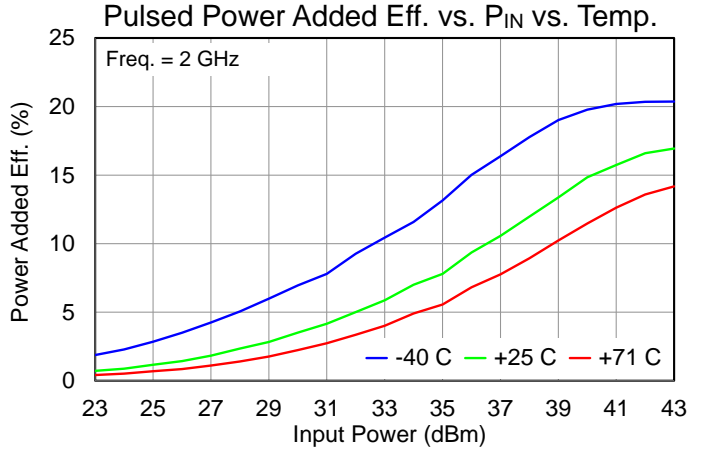
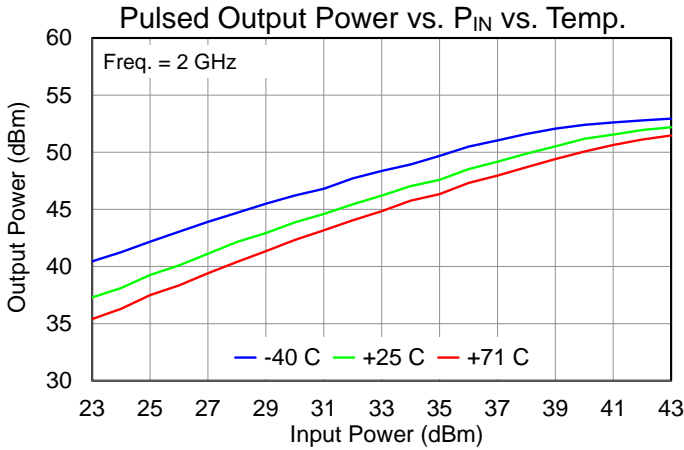

## Typical Performance – Linearity, Harmonics, Small Signal

Conditions unless otherwise specified:  $V_D = 18\text{ V}$ ,  $I_{DQ} = 54\text{ A}$ ,  $T = 25\text{ }^\circ\text{C}$ , CW

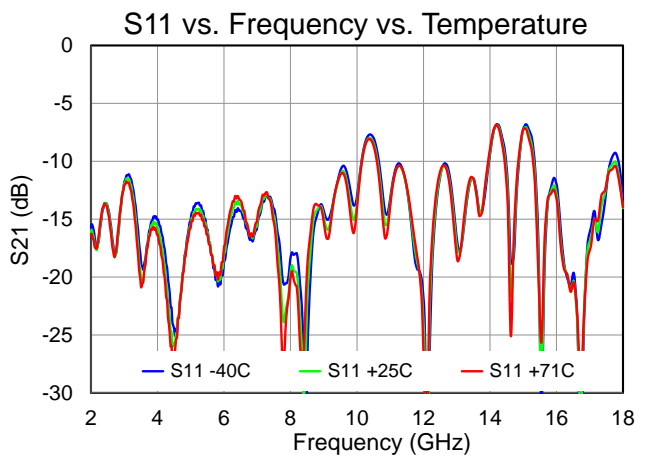
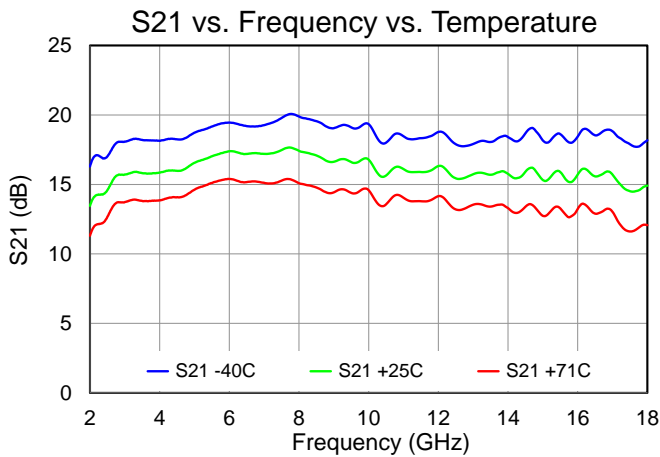
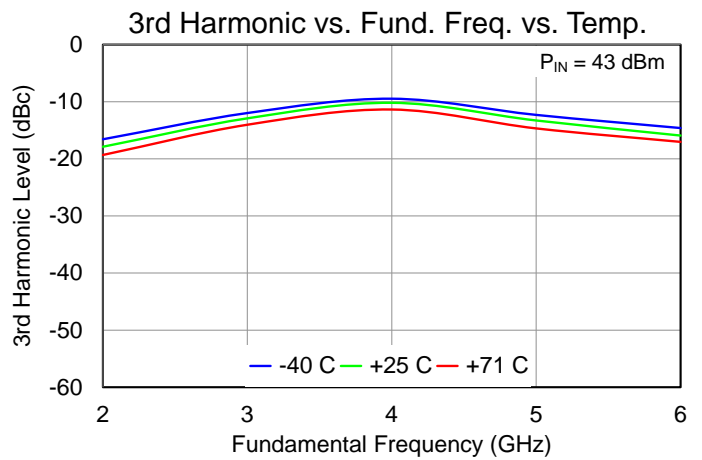
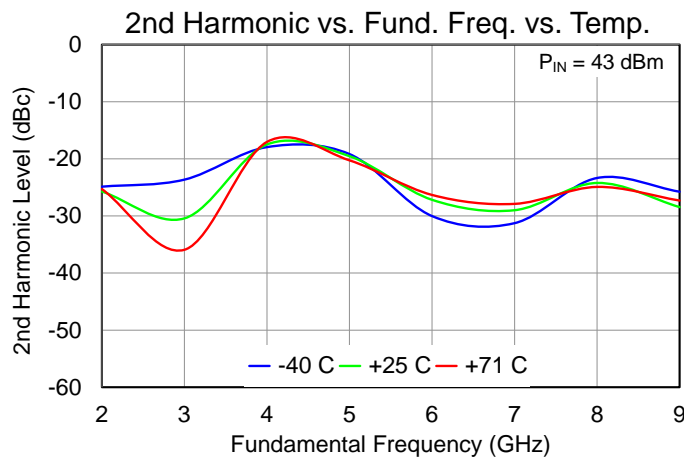
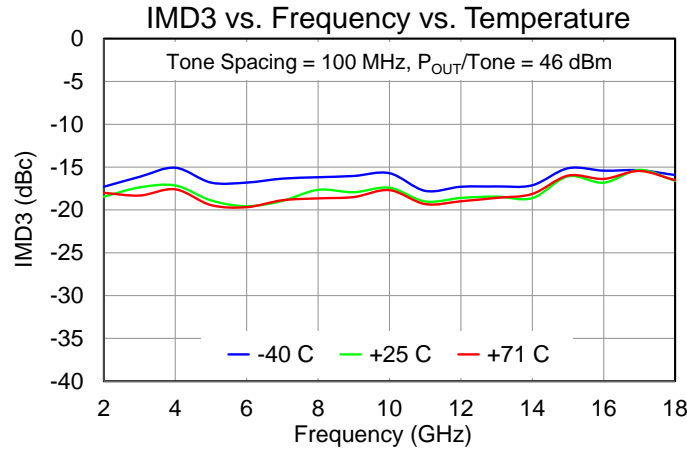

## Reliability Information

Conditions unless otherwise specified:  $V_D = 18\text{ V}$ ,  $P_{IN} = 43\text{ dBm}$

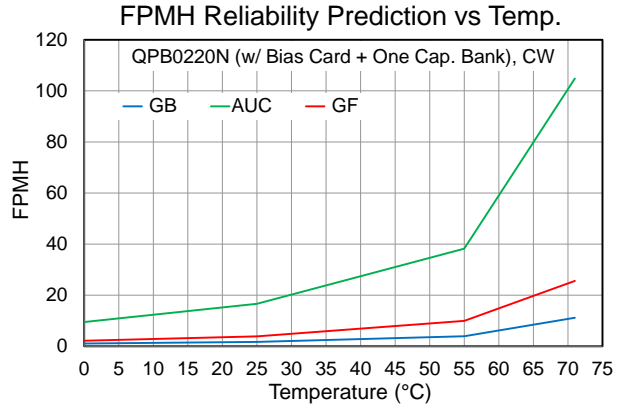
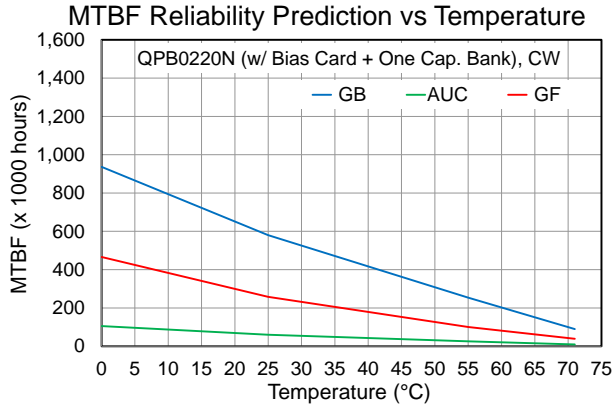

Calculations derived from MIL-HDBK-217F

Operational environments are:

GB – Ground Benign

GF – Ground Fixed

AUC – Airborne Uninhabited Cargo

**Block Diagram and Description**

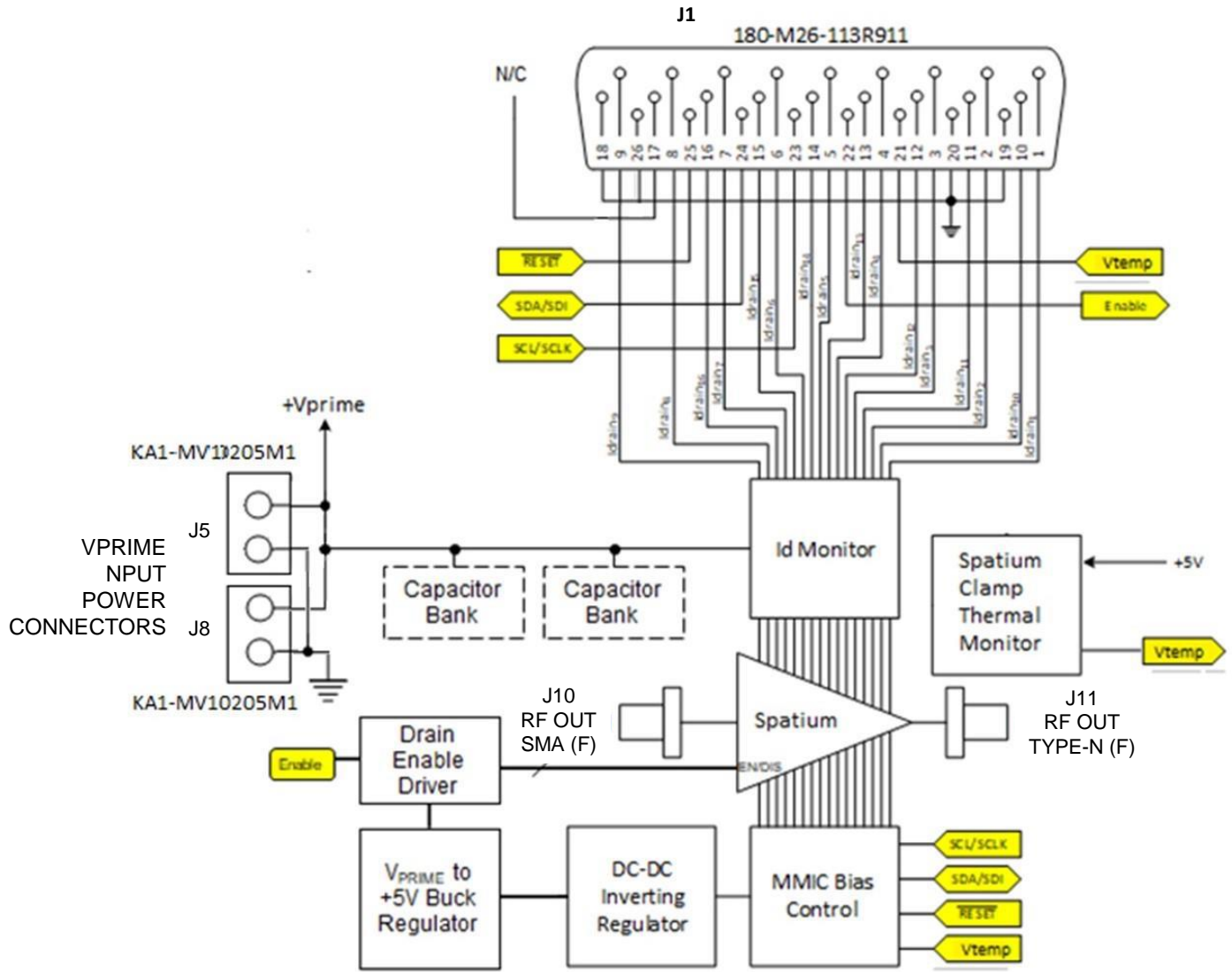

Connector	Label	Description
RF In	J10	SMA (F), DC Grounded
RF Out	J11	TYPE-N (F), DC Grounded
Auxiliary	J1	D-SUB HD 26POS (M), NORCOMP 180-M26-113R911, mates with 180-026-273L000
Power	J5, J8	HARWIN, KA1-MV10205M1, mates with KA1-2010298F1

## J1 Connector Pin Labels and Function Descriptions

Pin No.	Label	Description
1 – 16	IDS_1 – IDS_16	Amplifier bias monitoring, voltage output on these pins follows 0.5V/A times the current flowing through amplifiers 1 to 16 of the Spatium. Can be used for diagnosis, otherwise leave open
17 - 18	5V0	+5V internally generated reference voltage, can be used to supply 100mA of current if required, otherwise, leave open. Do not apply a voltage to these pins.
19 - 20	GND	Logic ground.
20 - 21	VTEMP	Temperature monitor <sup>1</sup>
22	ENABLE	5V CMOS logic command bit for setting the gain stages to lo power mode operation. 0V puts the unit into a low-power stage while 5V will allow normal operation, in the absence of an external logic signal (open), the amplifier will power on with the application of supply voltage.
23	SCL	I2C bus used to program amplifier (for factory use only).
24	SDA	I2C bus used to program amplifier (for factory use only).
25	RESET	I2C bus used to program amplifier (for factory use only).
26	GND	Logic ground

- Connects to Texas Instruments KMT87 temperature sensor output.  
 For relation between output voltage and temperature, please see the LMT87 datasheet.  
<https://www.ti.com/lit/ds/symlink/lmt87.pdf>

## Mechanical Information – Outline Drawing (Amp + Bias Card)

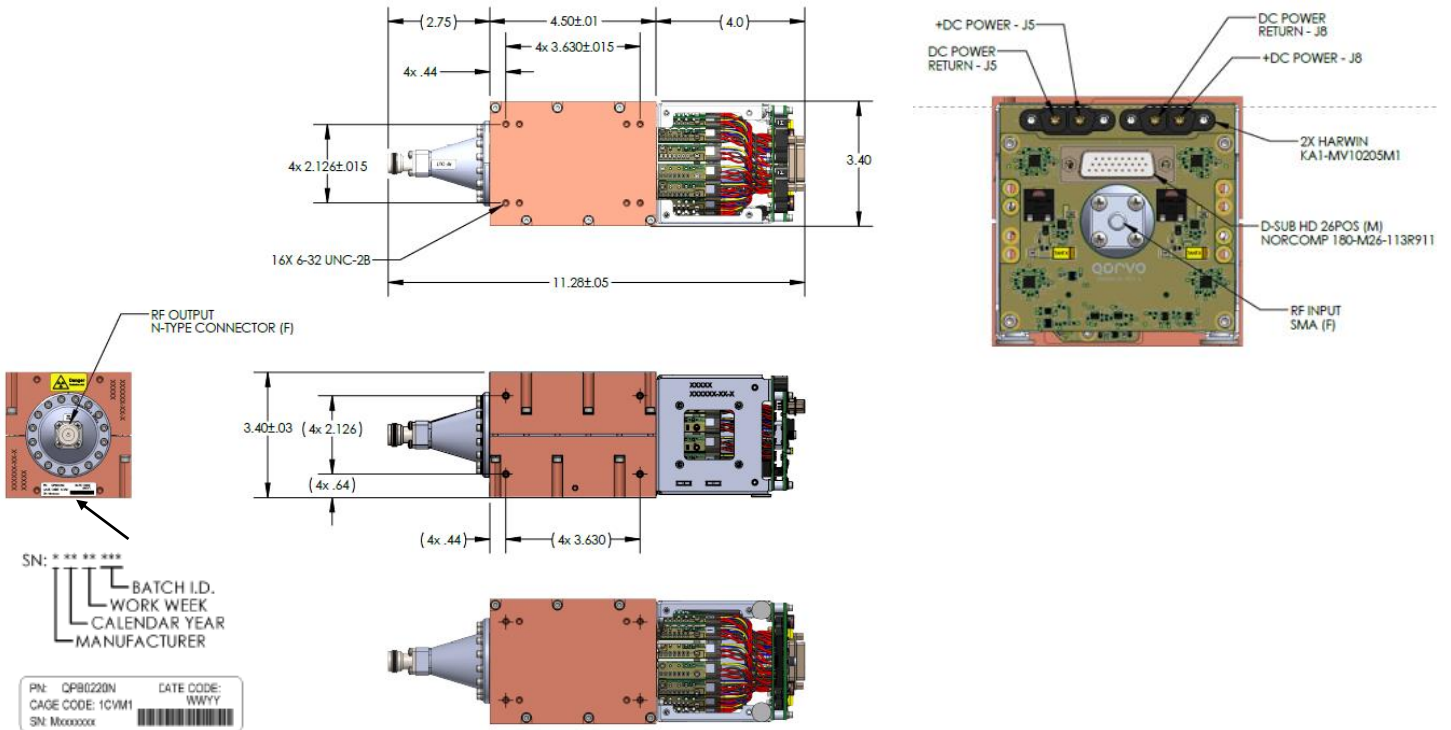

AS CONFIGURED W/O CAPACITOR BANKS

Dimensions are in INCHES

**Mechanical Information – Outline Drawing (Amp + Bias Card + 2 Cap. Banks)**

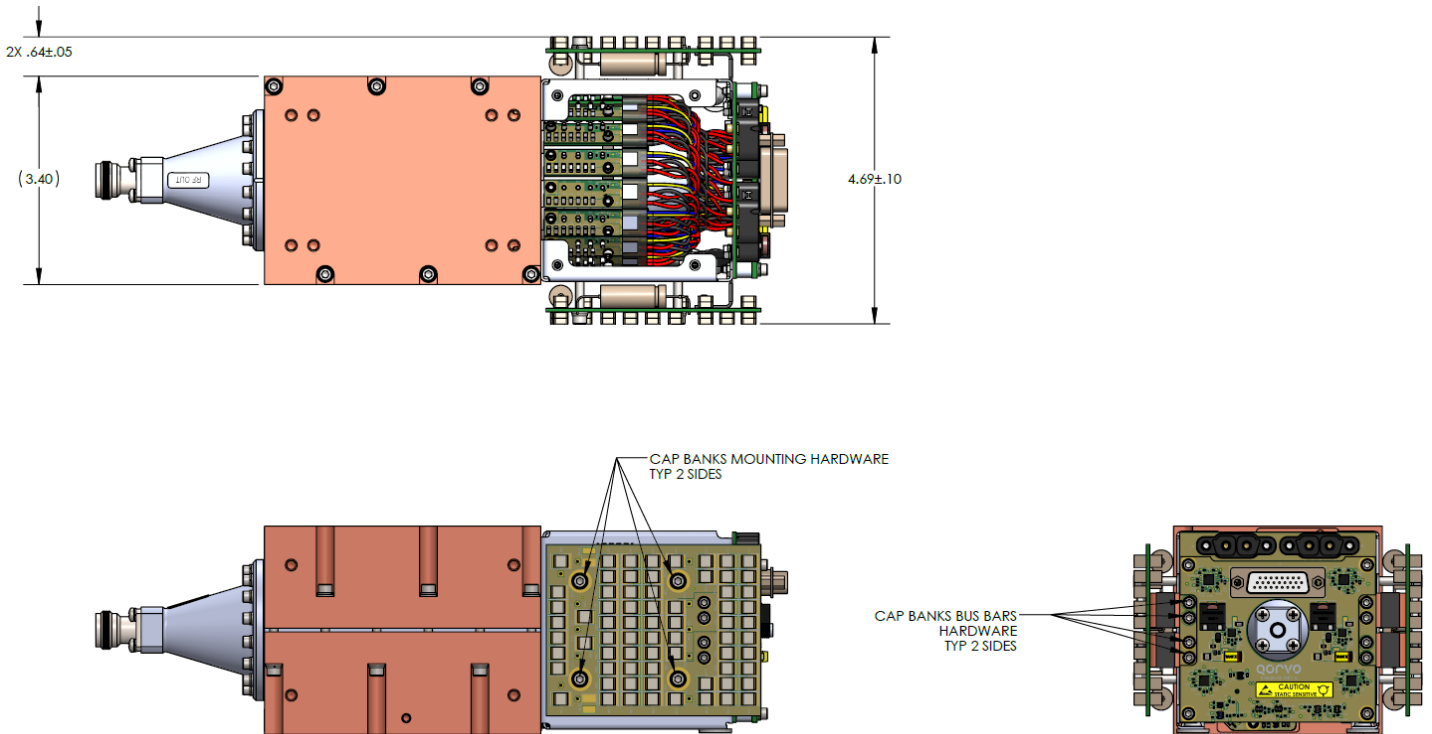

AS CONFIGURED WITH TWO CAPACITOR BANKS

Dimensions are in INCHES

## Handling Precautions

---



**Caution!**  
ESD-Sensitive Device

**RF VOLTAGE HAZARD:** Contact with RF fields at the output connector can cause burns or electric shock. High levels of RF/Microwave energy may be present when the unit is operating.

**HIGH DC CURRENT HAZARD:** High levels of DC current are present when the unit is operating.

## Contact Information

---

For the latest specifications, additional product information, worldwide sales and distribution locations:

**Web:** [www.qorvo.com](http://www.qorvo.com)

**Tel:** 1-844-890-8163

**Email:** [customer.support@qorvo.com](mailto:customer.support@qorvo.com)

## Important Notice

---

The information contained in this Data Sheet and any associated documents (“Data Sheet Information”) is believed to be reliable; however, Qorvo makes no warranties regarding the Data Sheet Information and assumes no responsibility or liability whatsoever for the use of said information. All Data Sheet Information is subject to change without notice. Customers should obtain and verify the latest relevant Data Sheet Information before placing orders for Qorvo® products. Data Sheet Information or the use thereof does not grant, explicitly, implicitly or otherwise any rights or licenses to any third party with respect to patents or any other intellectual property whether with regard to such Data Sheet Information itself or anything described by such information.

DATA SHEET INFORMATION DOES NOT CONSTITUTE A WARRANTY WITH RESPECT TO THE PRODUCTS DESCRIBED HEREIN, AND QORVO HEREBY DISCLAIMS ANY AND ALL WARRANTIES WITH RESPECT TO SUCH PRODUCTS WHETHER EXPRESS OR IMPLIED BY LAW, COURSE OF DEALING, COURSE OF PERFORMANCE, USAGE OF TRADE OR OTHERWISE, INCLUDING THE IMPLIED WARRANTIES OF MERCHANTABILITY AND FITNESS FOR A PARTICULAR PURPOSE. Without limiting the generality of the foregoing, Qorvo® products are not warranted or authorized for use as critical components in medical, life-saving, or life-sustaining applications, or other applications where a failure would reasonably be expected to cause severe personal injury or death. Applications described in the Data Sheet Information are for illustrative purposes only. Customers are responsible for validating that a particular product described in the Data Sheet Information is suitable for use in a particular application.

© 2025 Qorvo US, Inc. All rights reserved. This document is subject to copyright laws in various jurisdictions worldwide and may not be reproduced or distributed, in whole or in part, without the express written consent of Qorvo US, Inc. | QORVO® is a registered trademark of Qorvo US, Inc.

## Looking for pricing, stock, or lifecycle information?

Click below to explore more details on WIN SOURCE:

 [View QPB0220N on WIN SOURCE](#)

 [Qorvo US Inc. Information](#)

## Optimize Your Supply Chain with WIN SOURCE Solutions

-  Global Sourcing Solution
-  Obsolete Management
-  Cost Control Management
-  Shortage Management
-  Alternative Solution
-  Excess Inventory Management