

### FEATURES

- Wide input range 85-305VAC
- 5000m operating altitude
- OVC III over voltage category up to 2000m
- Operating temperature ratings: -40°C to +90°C
- 4kVAC isolation
- EN55032 class B compliant
- No load power consumption <100mW
- Industry standard footprint and pinning [P13]



Dimensions (LxWxH): 45.7 x 25.4 x 21.5mm (1.8 x 1.0 x 0.85 inch)  
52g (0.11 lbs)

### APPLICATIONS

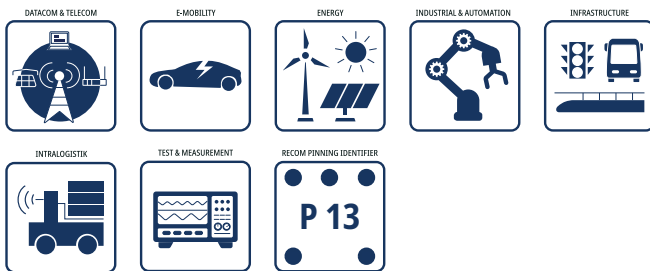

### SAFETY & EMC



### DESCRIPTION

The economy itemized RAC10E-K series are extra compact 1.8"x1" encapsulated PCB-mount AC/DC modules with a wide input operating range of 85 to 305Vac and come with international safety certifications for industrial, AV and ITE as well as household standards. These Power Supply modules with certifications to overvoltage category OVC III environments operate in a temperature range of -40°C to +90°C with up to 5000m operating altitude and offer fully protected single outputs as well as EMC class B compliance without the need of any external components.

### SELECTION GUIDE

Part Number	Input Voltage Range [VAC]	Output Voltage nom. [VDC]	Output Current max. [mA]	Efficiency typ. <sup>(1)</sup> [%]
RAC10E-3.3SK/277	85-305	3.3	2500	76
RAC10E-05SK/277	85-305	5	2000	80
RAC10E-12SK/277	85-305	12	833	83
RAC10E-15SK/277	85-305	15	666	83
RAC10E-24SK/277	85-305	24	416	84

Note1: Efficiency is tested at nominal input (230VAC) and full load at +25°C ambient

### MODEL NUMBERING



### ACCESSIBLE PART

Part Number	Description	Datasheet Link
RAC-ADAPT-ST1	adapter board with screw terminal connection	<a href="#">RAC-ADAPT-ST1.pdf</a>

### BASIC CHARACTERISTICS (measured @ $T_{AMB}= 25^{\circ}\text{C}$ , nom. $V_{IN}$ , full load and after warm-up unless otherwise stated)

Parameter	Condition	Min.	Typ.	Max.
Nominal Input Voltage	50/60Hz	100VAC		277VAC
Operating Range <sup>(2)</sup>	47/63Hz	85VAC	277VAC	305VAC
	DC	120VDC		430VDC
Input Current	$V_{IN}= 115\text{VAC}$			200mA
	$V_{IN}= 230\text{VAC}$			100mA
	$V_{IN}= 277\text{VAC}$			80mA
Inrush Current	cold start at $25^{\circ}\text{C}$	$V_{IN}= 115\text{VAC}$		20A
		$V_{IN}= 230/277\text{VAC}$		40A
No Load Power Consumption			75mW	100mW
Ecodesign Standby Mode Use (Available output power for stated input power)	$P_{IN}= 0.5\text{W}$		0.3W	
	$P_{IN}= 1.0\text{W}$		0.7W	
Input Frequency Range		47Hz		63Hz
Minimum Load		0%		
Power Factor	$V_{IN}= 115\text{VAC}$		0.6	
	$V_{IN}= 230\text{VAC}$		0.5	
Start-up time				50ms
Rise time				40ms
Hold-up time	$V_{IN}= 115\text{VAC}$	5ms		
	$V_{IN}= 230\text{VAC}$	30ms		
	$V_{IN}= 277\text{VAC}$	50ms		
Internal Operating Frequency	100% load at nominal $V_{IN}$		80kHz	
Output Ripple and Noise <sup>(3)</sup>	20MHz BW			150mVp-p

Note2: The products were submitted for safety files at AC-Input operation.

Note3: Measurements are made with a 0.1 $\mu\text{F}$  MLCC & 10 $\mu\text{F}$  E-cap in parallel across output. (low ESR)

### Efficiency vs. Load

RAC10E-3.3SK/277  
RAC10E-05SK/277

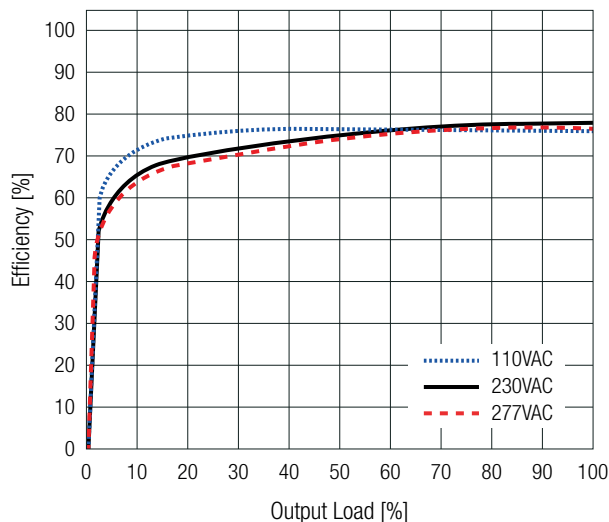

others

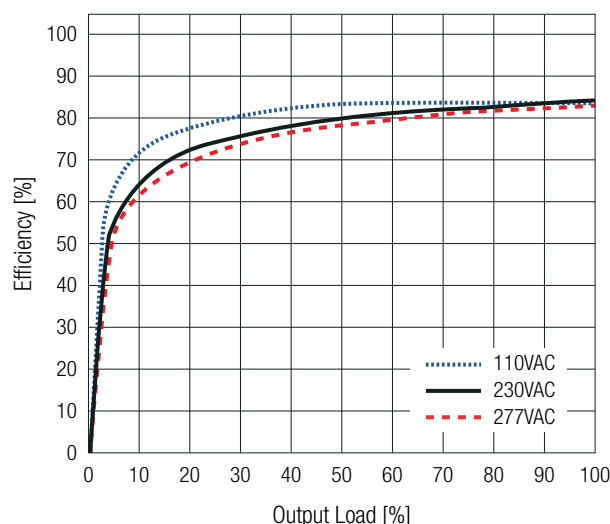

# RAC10E-K/277 Series $\diamond$ AC/DC Power Supply

## 10W $\diamond$ Input: 100-277VAC



**REGULATIONS (measured @  $T_{AMB} = 25^{\circ}C$ , nom.  $V_{IN}$ , full load and after warm-up unless otherwise stated)**

Parameter	Condition		Value
Output Accuracy			$\pm 2.0\%$ typ.
Line Regulation	low line to high line		$\pm 0.5\%$ typ.
Load Regulation	0% to 100% load	RAC10E-3.3SK/277	1.5% typ.
		others	0.5% typ.
Transient Response	25% load step change		3.0% max.
	recovery time		500 $\mu$ s max.

**Deviation vs. Load**

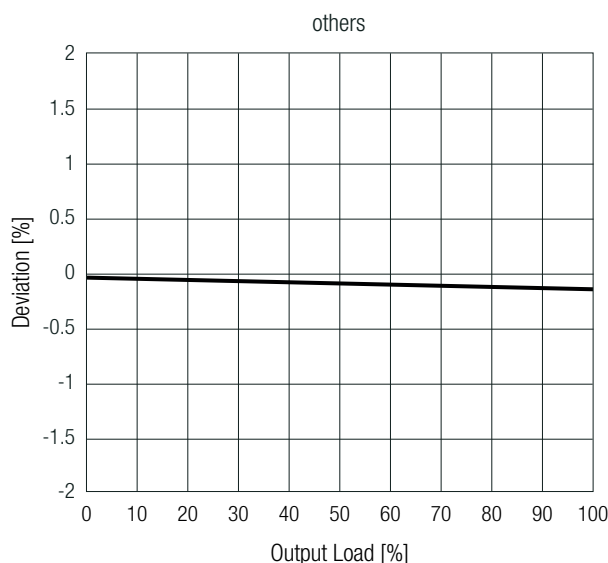
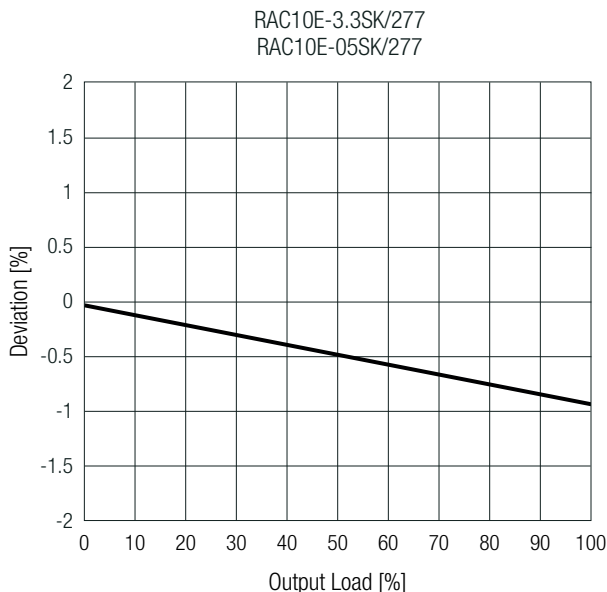

**PROTECTIONS (measured @  $T_{AMB} = 25^{\circ}C$ , nom.  $V_{IN}$ , full load and after warm-up unless otherwise stated)**

Parameter	Type	Value
Input Fuse	internal	T2A, slow blow type
Short Circuit Protection (SCP)	below 100m $\Omega$	hiccup mode, automatic restart
Over Voltage Protection (OVP)		105-120%, clamping, automatic restart
Over Current Protection (OCP)		128-155%, hiccup mode
Over Voltage Category (OVC)	according to 61558	OVC III (2000m)
	according to 62368-1	OVC II (5000m)
Isolation Voltage <sup>(4)</sup>	I/P to O/P	1 minute 4kVAC
Isolation Resistance		$V_{ISO} = 500VDC$ 1G $\Omega$ min.
Isolation Capacitance		I/P to O/P, 100kHz/0.1VDC 100pF max.
Insulation Grade	I/P to O/P	reinforced
Leakage Current	$V_{IN} = 277VAC$	0.05mA max.

Note4: For repeat Hi-Pot testing, reduce the time and/or the test voltage

# RAC10E-K/277 Series $\diamond$ AC/DC Power Supply

10W  $\diamond$  Input: 100-277VAC

**ENVIRONMENTAL** (measured @  $T_{AMB} = 25^{\circ}\text{C}$ , nom.  $V_{IN}$ , full load and after warm-up unless otherwise stated)

Parameter	Condition	Value	
Operating Ambient Temperature Range	@ natural convection (0.1m/s), refer to „Derating Graph“	-40°C to +90°C	
Maximum Case Temperature		+110°C	
Temperature Coefficient		$\pm 0.02\%/K$	
Operating Altitude	according to 62368-1	5000m (OVC II)	
	according to 61558	2000m (OVC III)	
Operating Humidity	non-condensing	95% RH max.	
Pollution Degree		PD2	
Vibration	according to MIL-STD-202G	10-500Hz, 2G 10min./1cycle, period 60min. each along x,y,z axes	
	according to IEC 60068-2-27	3 axis, 40 g half sine, 11 ms shock	
	according to IEC 60068-2-65	5-500Hz, 20m/s <sup>2</sup> , 1 Oct/min, 15min	
MTBF	according to MIL-HDBK-217F, G.B.	$T_{AMB} = +25^{\circ}\text{C}$	1710 x 10 <sup>3</sup> hours
		$T_{AMB} = +40^{\circ}\text{C}$	1460 x 10 <sup>3</sup> hours
		$T_{AMB} = +55^{\circ}\text{C}$	>35 x 10 <sup>3</sup> hours
Design Lifetime	$V_{IN} = 230\text{VAC}/60\text{Hz}$ and full load	$T_{AMB} = +55^{\circ}\text{C}$	>35 x 10 <sup>3</sup> hours

## Derating Graph

(@ Chamber and natural convection 0.1m/s)

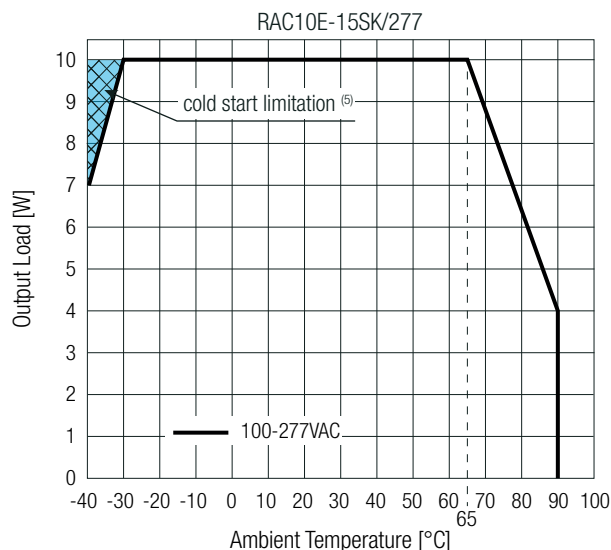
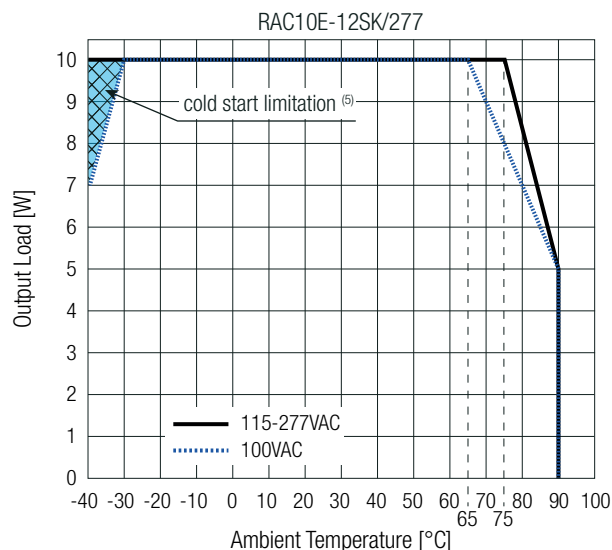
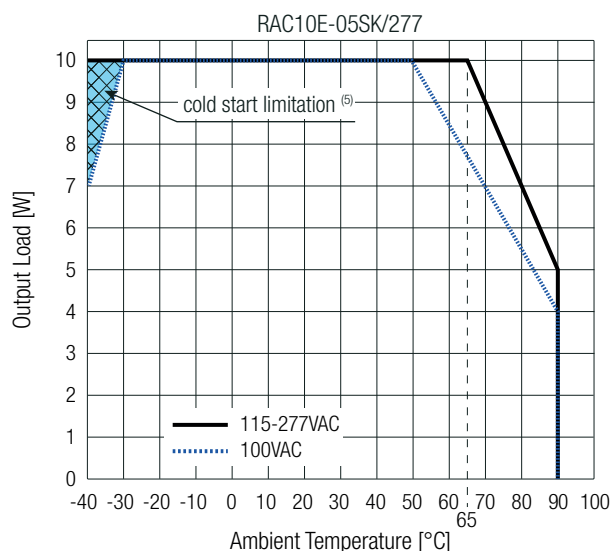
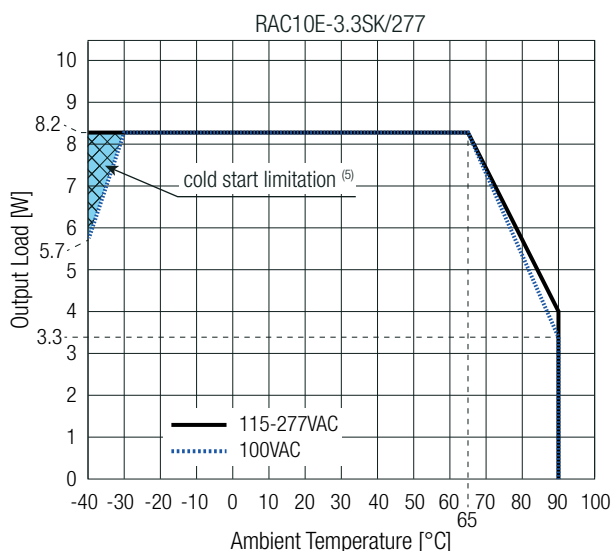

Note5: Cold start is limited to reduced output Power for 15V in general and for 3.3 to 12V versions at use in low line conditions

**ENVIRONMENTAL** (measured @  $T_{AMB} = 25^{\circ}\text{C}$ , nom.  $V_{IN}$ , full load and after warm-up unless otherwise stated)

### Derating Graph

(@ Chamber and natural convection 0.1m/s)

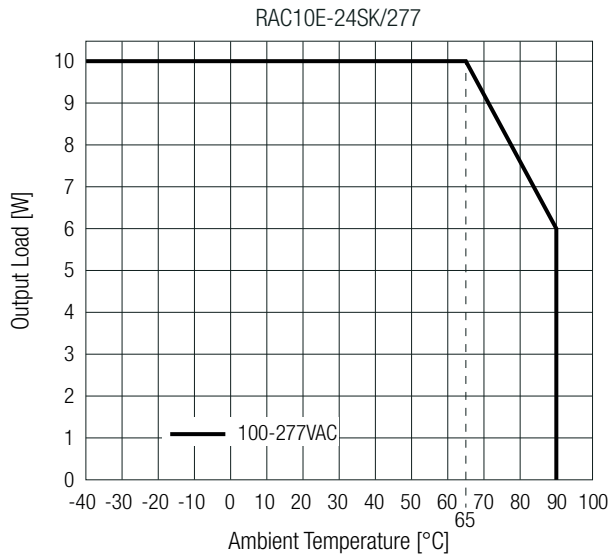

### SAFETY & CERTIFICATIONS

Certificate Type (Safety)	Report Number	Standard
Audio/Video, information and communication technology equipment - Safety requirements	E491408-A6019-UL	UL62368-1:2019 3rd Ed. CAN/CSA-C22.2 No. 62368-1:2019 3rd Ed.
Audio/video, information and communication technology equipment. Safety requirements (CB Scheme)	210824013	IEC62368-1:2018 3rd Ed.
Audio/video, information and communication technology equipment. Safety requirements (LVD)	210824013	EN IEC 62368-1:2020 + A11:2020
Audio/video, information and communication technology equipment. Safety requirements (CB Scheme)	210824014	IEC62368-1:2014 2nd Ed.
Audio/video, information and communication technology equipment. Safety requirements (LVD)		EN62368-1:2014 + A11:2017
Safety of power transformers, power supplies, reactors and similar products for supply voltages up to 1100 V (CB Scheme)	CN21F0GR-001 (OVC II)	IEC61558-1:2017
Safety of power transformers, power supplies, reactors and similar products for supply voltages up to 1100 V Part 2: Particular requirements (CB Scheme)		IEC61558-2-16:2009 1st Edition + A1:2013
Safety of power transformers, power supplies, reactors and similar products for supply voltages up to 1100 V (LVD)	CN21N7KP-001 (OVC II)	EN IEC 61558-1:2019
Safety of power transformers, power supplies, reactors and similar products for supply voltages up to 1100 V Part 2: Particular requirements (LVD)		EN61558-2-16:2009 + A1:2013
Safety of power transformers, power supplies, reactors and similar products for supply voltages up to 1100 V (CB Scheme)	CN21LEIF-001 (OVC III)	IEC61558-1:2017
Safety of power transformers, power supplies, reactors and similar products for supply voltages up to 1100 V Part 2: Particular requirements (CB Scheme)		IEC61558-2-16:2009 1st Edition + A1:2013
Safety of power transformers, power supplies, reactors and similar products for supply voltages up to 1100 V	CN21V98T-001 (OVC III)	EN IEC 61558-1:2019
Safety of power transformers, power supplies, reactors and similar products for supply voltages up to 1100 V Part 2: Particular requirements		EN61558-2-16:2009 + A1:2013
RoHS2		RoHS-2011/65/EU + AM-2015/863

### SAFETY & CERTIFICATIONS

EMC Compliance	Condition	Standard / Criterion
Electromagnetic compatibility of multimedia equipment - Emission requirements <sup>(6)</sup>	O/P connected to GND: refer to: „PELV installation“ and floating output; without external filter	EN55032:2017, Class B
Low voltage power supplies, d.c. output Part 3: Electromagnetic compatibility (EMC)		EN IEC 61204-3:2018, Class B
Limitations on the amount of electromagnetic interference allowed from digital and electronic devices, industrial, scientific, and medical equipment		FCC 47 CFR Part 18
ESD Electrostatic discharge immunity test	Air: $\pm 2, 4, 8$ kV Contact: $\pm 4$ kV	IEC61000-4-2:2008, Criteria A EN61000-4-2:2009, Criteria A
Radiated, radio-frequency, electromagnetic field immunity test	10 V/m (80-1000 MHz) 3 V/m (1400-2000MHz) 1 V/m (2000-2700MHz)	IEC/EN61000-4-3:2006+A2:2010, Criteria A
Fast Transient and Burst Immunity	AC Power Port: L, N: $\pm 2$ kV	IEC/EN61000-4-4:2012, Criteria A
	AC Power Port: L-N: $\pm 2$ kV	IEC/EN61000-4-4:2012, Criteria B
Surge Immunity	AC Power Port: L-N 1.0kV	IEC/EN61000-4-5:2014, Criteria B
Immunity to conducted disturbances, induced by radio-frequency fields	AC Power Port: 10 Vrms (0.15-80MHz)	IEC61000-4-6:2013, Criteria A EN61000-4-6:2014, Criteria A
Power Magnetic Field Immunity	30 A/m	IEC61000-4-8:2009, Criteria A EN61000-4-8:2010, Criteria A
Voltage Dips	100% (0.5P, 1.0P) 20, 30, 60%	IEC/EN61000-4-11:2004, Criteria A
Voltage Interruptions	100%	IEC/EN61000-4-11:2004, Criteria B
Limits of Harmonic Current Emissions		EN61000-3-2:2014
Limits of Voltage Fluctuations & Flicker		EN61000-3-3:2013

### Suggested external filter for PELV installation

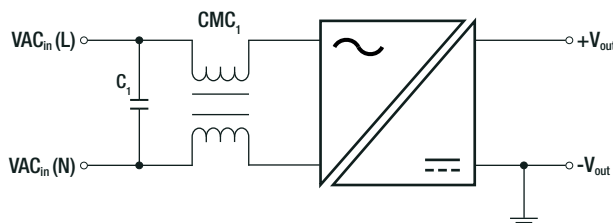

### Component List

$C_1$ <sup>(7)</sup>	$CMC_1$
100nF	45mH: RACMC45-500/UF9.8 (coming soon)

Note6: For PE or earth referenced output connections, it is suggested to add a 45mH CMC to the AC-Inlet, to meet EN55032 class “B” requirements

Note7: For usage with longer cables it is recommended to add an additional 100nF

### DIMENSION & PHYSICAL CHARACTERISTICS

Parameter	Type	Value
Materials	case/baseplate	black plastic, (UL94-V0)
	potting	silicone, (UL94-V0)
	PCB	FR4, (UL94-V0)
Dimension (LxWxH)		45.7 x 25.4 x 21.5mm 1.8 x 1.0 x 0.85 inch
Weight		52g typ. 0.11 lbs

### DIMENSION & PHYSICAL CHARACTERISTICS

Dimension Drawing (mm)

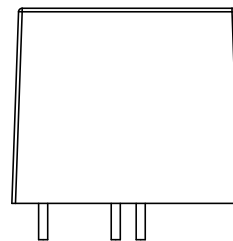
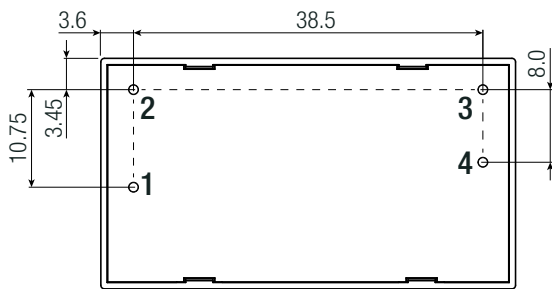
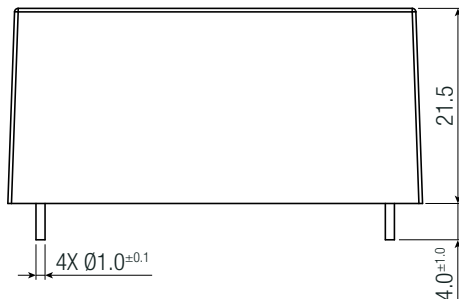
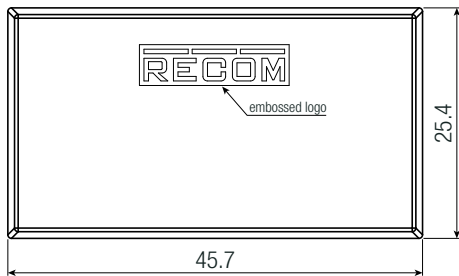
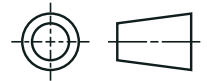

Recommended Footprint Details

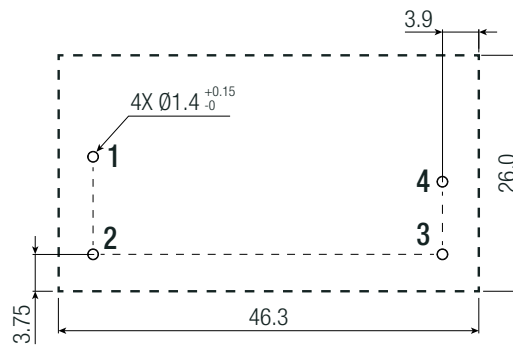

Pinning Information

Pin #	Function
1	VAC in (N)
2	VAC in (L)
3	-Vout
4	+Vout

Tolerance: x.x= ±0.5mm  
x.xx= ±0.25mm

### PACKAGING INFORMATION

Parameter	Type	Value
Packaging Dimension (LxWxH)	tube	490.0 x 56.0 x 36.0mm
Packaging Quantity		17pcs
Storage Temperature Range		-40°C to +85°C
Storage Humidity	non-condensing	20-90% RH max.

The product information and specifications may be subject to changes even without prior written notice. The product has been designed for various applications; its suitability lies in the responsibility of each customer. The products are not authorized for use in safety-critical applications without RECOM's explicit written consent. A safety-critical application is an application where a failure may reasonably be expected to endanger or cause loss of life, inflict bodily harm or damage property. The applicant shall indemnify and hold harmless RECOM, its affiliated companies and its representatives against any damage claims in connection with the unauthorized use of RECOM products in such safety-critical applications.

## Looking for pricing, stock, or lifecycle information?

Click below to explore more details on WIN SOURCE:

- ⊖ [View RAC10E-12SK/277 on WIN SOURCE](#)
- ⊖ [Recom Power Information](#)

## Optimize Your Supply Chain with WIN SOURCE Solutions

- ✓ Global Sourcing Solution
- ✓ Obsolete Management
- ✓ Cost Control Management
- ✓ Shortage Management
- ✓ Alternative Solution
- ✓ Excess Inventory Management