

# Features

# Switching Regulator

- Efficiency up to 97%, no heatsinks required
- Pin compatible with LM78XX linears
- Low profile (L/W/H=11.5 x 8.5 x 17.5mm)
- Wide input range
- Short circuit protection, thermal shutdown
- Low ripple and noise
- „L“ version with 90° pins
- Positive to negative converter

# RECOM DC/DC Converter

## R-78B-1.0(L)

1.0 Amp  
SIP3  
Single Output



### Description

The R-78Bxx-1.0 series high efficiency switching regulators are ideally suited to replace 78xx linear regulators and are pin compatible. The efficiency of up to 97% means that very little energy is wasted as heat so there is no need for any heat sinks with their additional space and mounting costs. The L-Version with 90° pins allows direct replacement for laid-flat regulators where component height is at a premium. Low ripple and noise figures and a short circuit input current of typically only 10mA round off the specifications of this versatile converter series.

### Selection Guide

| Part Number                 | Input Voltage Range [VDC] | Output Voltage [VDC] | Output Current [A] | Efficiency    |                |
|-----------------------------|---------------------------|----------------------|--------------------|---------------|----------------|
|                             |                           |                      |                    | @ min Vin [%] | @ max. Vin [%] |
| R-78B1.5-1.0 <sup>(1)</sup> | 4.75 - 26                 | 1.5                  | 1.0                | 77            | 71             |
| R-78B1.8-1.0 <sup>(1)</sup> | 4.75 - 26                 | 1.8                  | 1.0                | 80            | 74             |
| R-78B2.5-1.0 <sup>(1)</sup> | 4.75 - 32                 | 2.5                  | 1.0                | 85            | 78             |
| R-78B3.3-1.0 <sup>(1)</sup> | 4.75 - 32                 | 3.3                  | 1.0                | 89            | 83             |
| R-78B5.0-1.0 <sup>(1)</sup> | 6.5 - 32                  | 5.0                  | 1.0                | 93            | 88             |
| R-78B6.5-1.0 <sup>(1)</sup> | 9.0 - 32                  | 6.5                  | 1.0                | 94            | 90             |
| R-78B9.0-1.0 <sup>(1)</sup> | 12 - 32                   | 9.0                  | 1.0                | 95            | 93             |
| R-78B12-1.0 <sup>(1)</sup>  | 16 - 32                   | 12                   | 1.0                | 96            | 95             |
| R-78B15-1.0 <sup>(1)</sup>  | 20 - 32                   | 15                   | 1.0                | 97            | 96             |

### Model Numbering

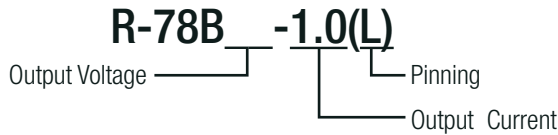

#### Notes:

Note1: add suffix "L" for 90° bent pins, e.g. R-78B5.0-1.0L

### Specifications (measured @ Ta= 25°C, 10% minimum load, unless otherwise stated)

| BASIC CHARACTERISTICS                  |  |                                       |        |                    |                    |
|--|--|---------------------------------------|--------|--------------------|--------------------|
| Parameter                              | Condition  |                                       | Min.   | Typ.               | Max.               |
| Absolute Maximum Input Voltage         | 1.5Vout , 1.8Vout<br>2.5Vout to 15Vout   |                                       |        |                    | 26VDC<br>34VDC     |
| Quiescent Current                      | nom. Vin= 24VDC  |                                       |        | 5mA                | 7mA                |
| Internal Power Dissipation             | Vout= 1.5VDC   |                                       |        |                    | 0.65W              |
| Internal Operating Frequency           | nom. Vin= 24VDC  |                                       | 280kHz | 330kHz             | 380kHz             |
| Minimum Load <sup>(2)</sup>            |  |                                       | 0%     |                    |                    |
| Output Ripple and Noise <sup>(3)</sup> | 20MHz BW   | 1.5Vout to 6.5Vout<br>9Vout to 15Vout |        | 15mVp-p<br>25mVp-p | 20mVp-p<br>35mVp-p |
| Ref. Back Ripple Current               |  |                                       |        | 150mA              | 200mA-p-p          |
| Absolute Maximum Capacitive Load       | 1 second start up, no external components<br><1 second start up + diode protection circuit |                                       |        |                    | 470µF<br>6800µF    |

#### Notes:

Note2: Operation under no load will not harm the converter, but specifications may not be met  
A minimum load of 10mA is recommended

Note3: Output Ripple and Noise is tested from 10% to 100% load

continued on next page

EN55032 compliant  
IEC/EN60950-1 certified

Specifications (measured @ Ta= 25°C, 10% minimum load, unless otherwise stated)

Efficiency vs. Vin (full load)

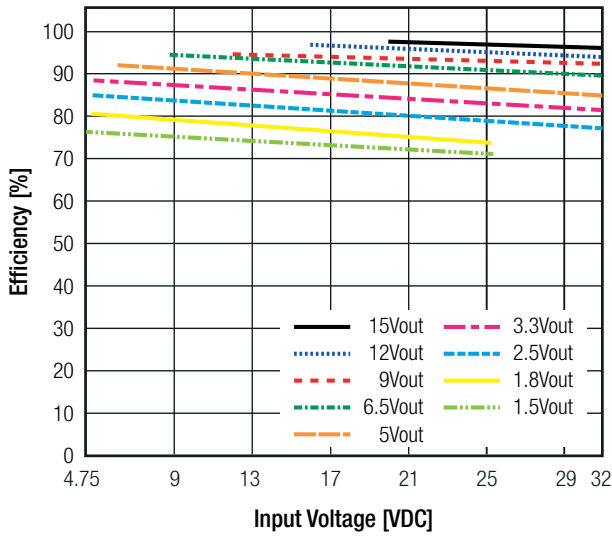

Ripple vs. Vin (full load)

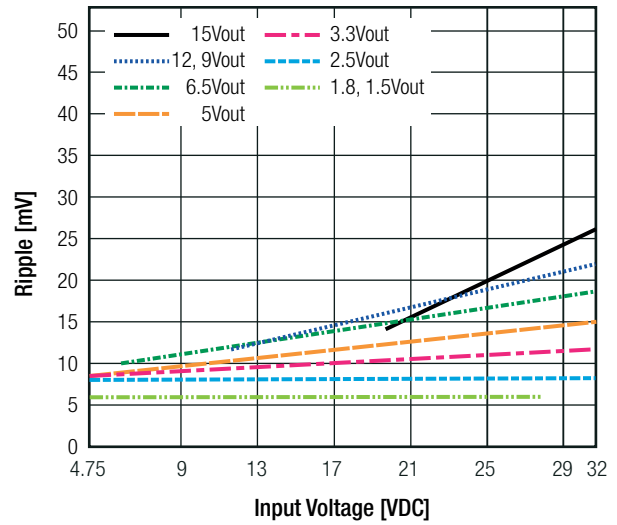

Efficiency vs. Load (max. Vin)

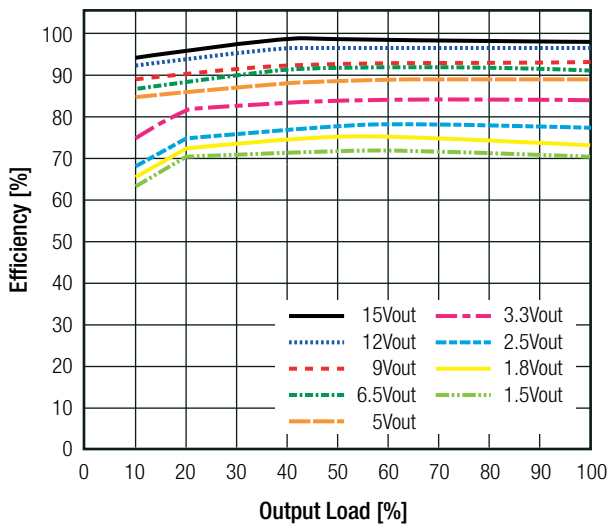

Ripple vs. Load (max. Vin)

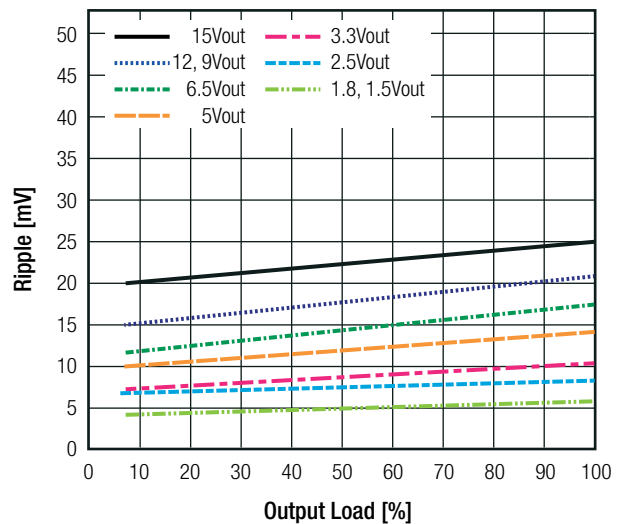

Efficiency vs. Load (min. Vin)

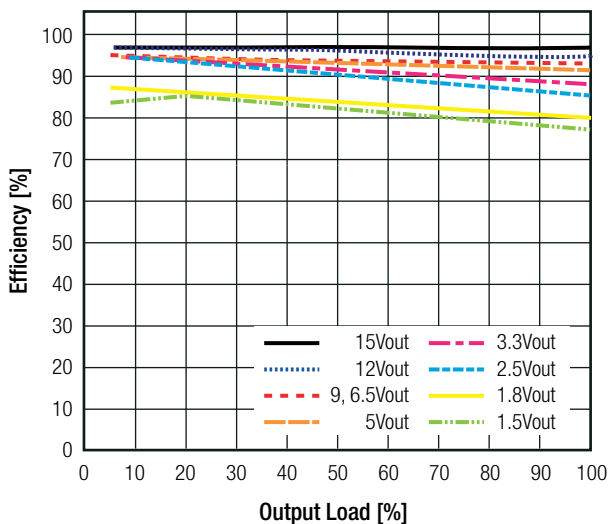

Ripple vs. Load (min. Vin)

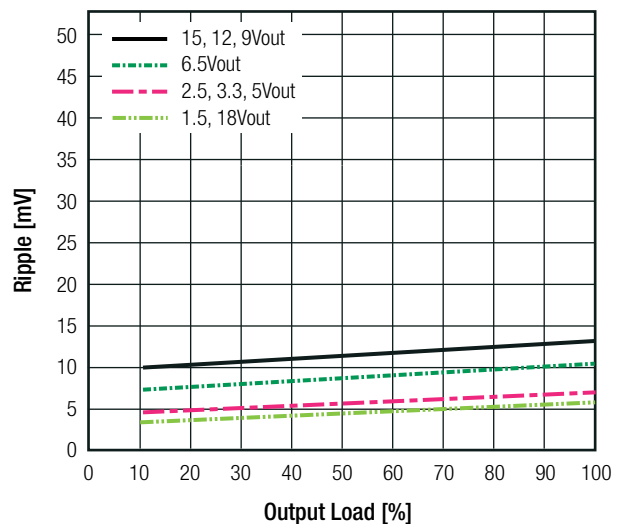

**Specifications** (measured @ Ta= 25°C, 10% minimum load, unless otherwise stated)

**REGULATIONS**

| Parameter          | Condition                        |                    | Value                     |
|--------------------|----------------------------------|--------------------|---------------------------|
| Output Accuracy    | 100% load                        |                    | ±2.0% typ / ±3.0% max.    |
| Line Regulation    | low line to high line, 100% load | 1.5Vout to 6.5Vout | ±0.2% typ. / ±0.4% max.   |
|                    |                                  | 9Vout to 15Vout    | ±0.1% typ. / ±0.2% max.   |
| Load Regulation    | 10% to 100% load                 | 1.5Vout to 6.5Vout | ±0.4% typ. / ±0.6% max.   |
|                    |                                  | 9Vout to 15Vout    | ±0.25% typ. / ±0.4% max.  |
| Transient Response | 100% <-> 50% load                |                    | ±100mV typ. / ±150mV max. |
|                    | Recovery Time                    |                    | 1.0ms typ. / 1.5ms max.   |

**PROTECTIONS**

| Parameter                      | Condition       | Value                          |
|--------------------------------|-----------------|--------------------------------|
| Short Circuit Protection (SCP) | below 100mΩ     | continuous, automatic recovery |
| Short Circuit Input Current    | nom. Vin= 24VDC | 60mA max.                      |

**Optional Diode Protection Circuit**

Add a blocking diode to Vout if current can flow backwards into the output, as this can damage the converter when it is powered down.

The diode can either be fitted across the device if the source is low impedance or fitted in series with the output (recommended).

**Optional Protection 1:**

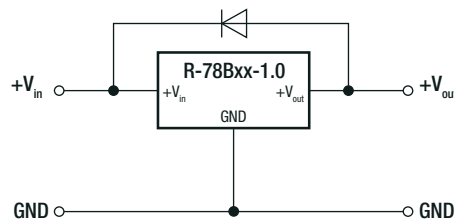

**Optional Protection 2:**

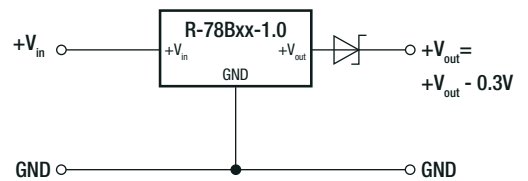

**Protection Circuit**

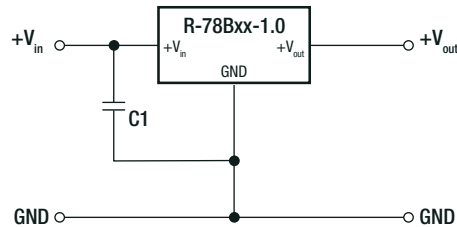

To protect the converter during power-up, use C1=22µF if Vin>30V

**ENVIRONMENTAL**

| Parameter                   | Condition                        |       | Value                        |
|-----------------------------|----------------------------------|-------|------------------------------|
| Operating Temperature Range | with derating (see graph)        |       | -40°C to +85°C               |
| Maximum Case Temperature    |                                  |       | +100°C                       |
| Temperature Coefficient     |                                  |       | ±0.015%/K                    |
| Thermal Impedance           | 0.1m/s, vertical                 |       | 60K/W                        |
| Operating Altitude          |                                  |       | 2000m                        |
| Operating Humidity          | non-condensing                   |       | 95% RH max.                  |
| Pollution Degree            |                                  |       | PD2                          |
| MTBF                        | according to MIL-HDBK-217F, G.B. | +25°C | 8593 x 10 <sup>3</sup> hours |

continued on next page

**Specifications** (measured @ Ta= 25°C, 10% minimum load, unless otherwise stated)

Derating Graph

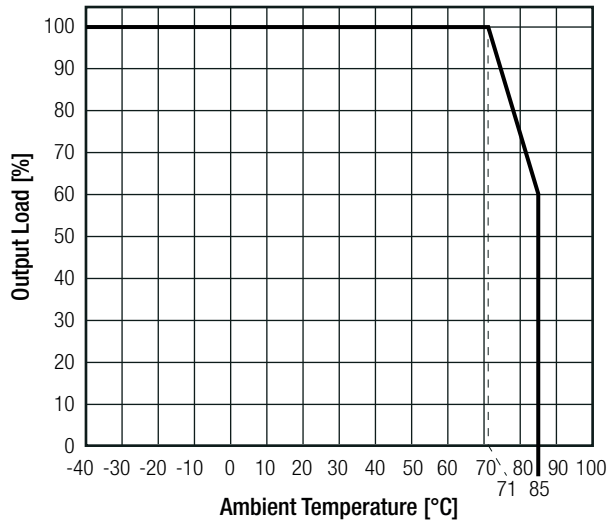

**SAFETY AND CERTIFICATIONS**

| Certificate Type (Safety)   | Report / File Number | Standard   |
|---|----------------------|--|
| Information Technology Equipment, General Requirements for Safety | 1603123              | IEC60950-1:2005, 2nd Edition + AM 2:2013<br>EN60950-1:2006 + AM 2:2013 |
| EAC   | RU-AT.49.09571       | TP TC 004/2011   |
| RoHS 2+   |                      | RoHS 2011/65/EU + AM2015/863   |

| EMC Compliance  | Condition  | Standard / Criterion    |
|---|--|-------------------------|
| Electromagnetic compatibility of multimedia equipment - Emission requirements | with external filter (see filter suggestion below) | EN55032, Class A and B  |
| ESD Electrostatic discharge immunity test                                     | Air ±8kV, Contact ±4kV                             | EN61000-4-2, Criteria A |
| Radiated, radio-frequency, electromagnetic field immunity test                | 3V/m   | EN61000-4-3, Criteria A |

**EMC Filter Suggestion according to EN55032**

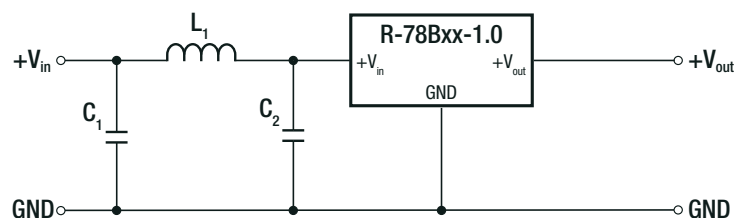

**Component List Class A**

| MODEL           | C1                | C2                | L1                     |
|-----------------|-------------------|-------------------|------------------------|
| R-78B5.0-1.0(L) | 10µF<br>100V MLCC | 4.7µF<br>50V MLCC | 3.9µH choke<br>RLS-397 |
| R-78B12-1.0(L)  |                   |                   |                        |
| R-78B15-1.0(L)  |                   |                   |                        |

**Component List Class B**

| MODEL           | C1                | C2                | L1                    |
|-----------------|-------------------|-------------------|-----------------------|
| R-78B5.0-1.0(L) | 10µF<br>100V MLCC | 10µF<br>100V MLCC | 12µH choke<br>RLS-126 |
| R-78B12-1.0(L)  |                   |                   |                       |
| R-78B15-1.0(L)  |                   |                   |                       |

**Notes:**

Note4: Filter suggestions are valid for indicated part numbers only. For other part numbers, please contact RECOM tech support for advice

**Specifications** (measured @ Ta= 25°C, 10% minimum load, unless otherwise stated)

### DIMENSION AND PHYSICAL CHARACTERISTICS

| Parameter                 | Type         | Value  |
|---------------------------|--------------|--|
| Material                  | case potting | non-conductive black plastic, (UL94 V-0)<br>silicone, (UL94 V-0) |
| Package Dimension (LxWxH) |              | 11.5 x 8.5 x 17.5mm  |
| Package Weight            |              | 4g typ.  |

#### Dimension Drawing (mm)

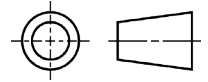
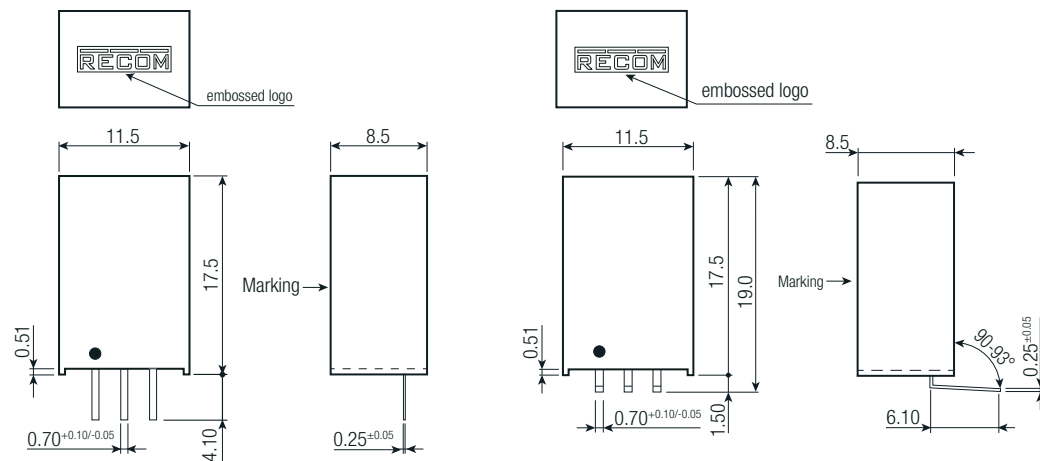

#### Pin Connections

| Pin # | Single |
|-------|--------|
| 1     | +Vin   |
| 2     | GND    |
| 3     | +Vout  |

Tolerance: xx.x= ±0.5mm  
xx.xx= ±0.25mm

#### Recommended Footprint Details

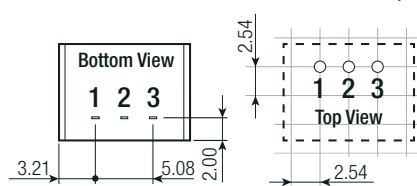

#### Recommended Footprint Details

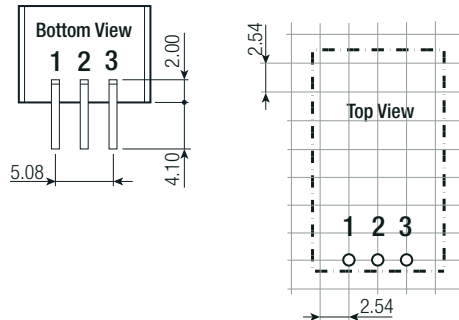

### INSTALLATION AND APPLICATION

#### Positive to Negative Converter

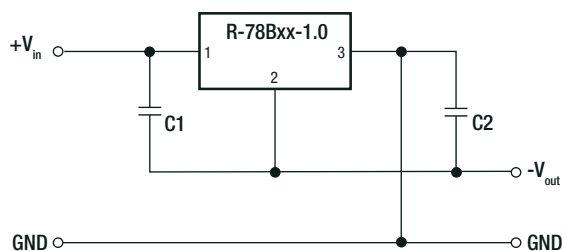

C1 and C2 are required and should be fitted close to the converter pins.

Maximum capacitive load including C2 is 220µF

#### Pin Connections

| Pin # | Negative | Positive |
|-------|----------|----------|
| 1     | +Vin     | +Vin     |
| 2     | -Vout    | GND      |
| 3     | GND      | +Vout    |

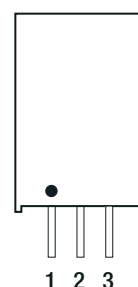

continued on next page

**Specifications** (measured @ Ta= 25°C, 10% minimum load, unless otherwise stated)

### Selection Guide - Negative Output

| Part Number  | Input Voltage Range [VDC] | Output Voltage [VDC] | Output Current [A] | Efficiency    |                | External Capacitor |                   |
|--------------|---------------------------|----------------------|--------------------|---------------|----------------|--------------------|-------------------|
|              |                           |                      |                    | @ min Vin [%] | @ max. Vin [%] | C1                 | C2 <sup>(5)</sup> |
| R-78B1.5-1.0 | 4.75 - 28                 | -1.5                 | -0.6               | 70            | 68             | 10µF/50V           | 22µF/6.3V         |
| R-78B1.8-1.0 | 4.75 - 28                 | -1.8                 | -0.6               | 72            | 72             | 10µF/50V           | 22µF/6.3V         |
| R-78B2.5-1.0 | 4.75 - 28                 | -2.5                 | -0.6               | 75            | 77             | 10µF/50V           | 22µF/6.3V         |
| R-78B3.3-1.0 | 4.75 - 28                 | -3.3                 | -0.6               | 77            | 80             | 10µF/50V           | 22µF/6.3V         |
| R-78B5.0-1.0 | 6.5 - 28                  | -5.0                 | -0.6               | 83            | 85             | 10µF/50V           | 22µF/10V          |
| R-78B6.5-1.0 | 8.0 - 26                  | -6.5                 | -0.4               | 84            | 87             | 10µF/50V           | 10µF/10V          |
| R-78B9.0-1.0 | 8.0 - 18                  | -9.0                 | -0.4               | 88            | 89             | 10µF/25V           | 10µF/25V          |
| R-78B12-1.0  | 8.0 - 18                  | -12                  | -0.3               | 89            | 90             | 10µF/25V           | 10µF/25V          |
| R-78B15-1.0  | 8.0 - 18                  | -15                  | -0.3               | 89            | 91             | 10µF/25V           | 10µF/25V          |

**Notes:**

Note5: Maximum Capacitive Load including C2 is 220µF

### Dual Output (two Converters) with Negative Output

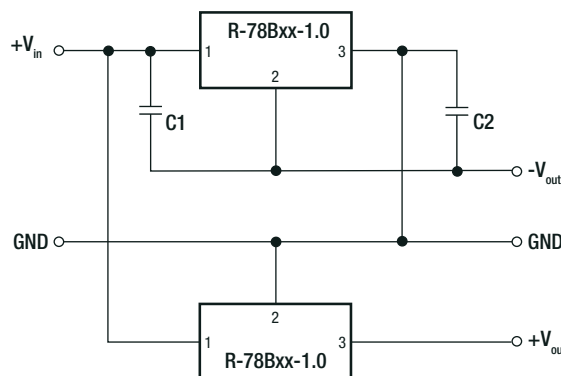

### Application Examples

#### High Efficiency Multiple Output

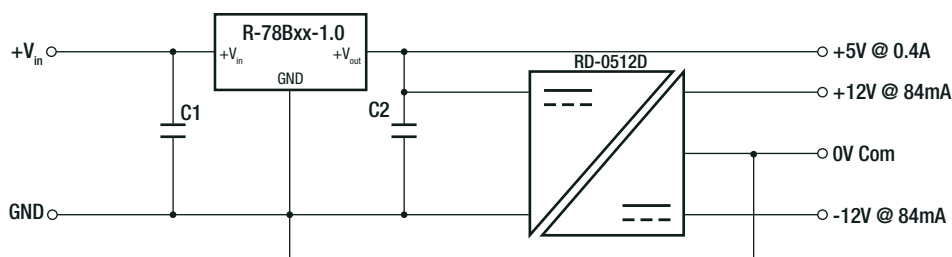

C1 optional;  
C2 required (further decoupling filtering may be necessary between the two converters)

- Wide input range 4.75V to 34V
- ±12V outputs for analogue circuits, e.g. instrumentation amplifier
- +5V output for digital circuits

continued on next page

**Specifications** (measured @ Ta= 25°C, 10% minimum load, unless otherwise stated)

**Isolated, Wide Input Range, Distributed Power Architecture (Point-of-Load)**

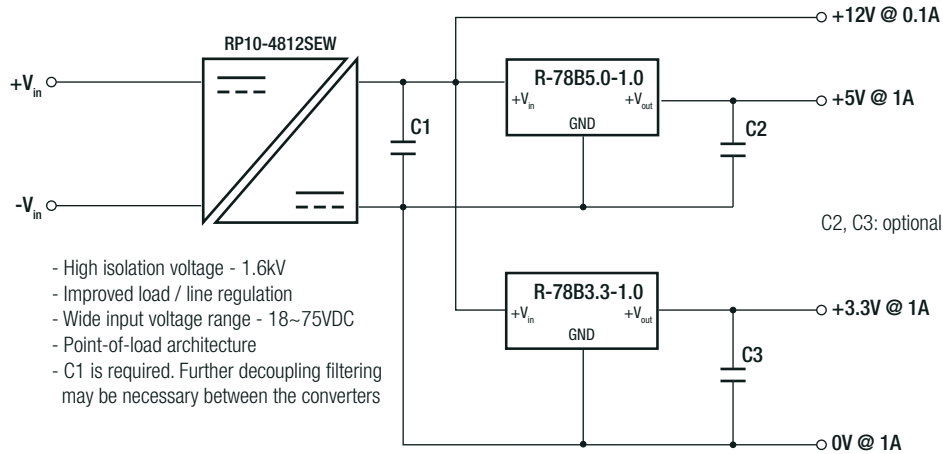



**PACKAGING INFORMATION**

| Parameter                   | Type |                                   | Value  |
|-----------------------------|------|-----------------------------------|--|
|                             | tube | without suffix<br>with suffix "L" |  |
| Packaging Dimension (LxWxH) |      |                                   | 520.0 x 25.1 x 10.6mm<br>520.0 x 26.1 x 15.8mm |
| Packaging Quantity          | tube |                                   | 42pcs  |
| Storage Temperature Range   |      |                                   | -55°C to +125°C                                |
| Storage Humidity            |      |                                   | 95% RH max.                                    |

The product information and specifications may be subject to changes even without prior written notice. The product has been designed for various applications; its suitability lies in the responsibility of each customer. The products are not authorized for use in safety-critical applications without RECOM's explicit written consent. A safety-critical application is an application where a failure may reasonably be expected to endanger or cause loss of life, inflict bodily harm or damage property. The applicant shall indemnify and hold harmless RECOM, its affiliated companies and its representatives against any damage claims in connection with the unauthorized use of RECOM products in such safety-critical applications.

## Looking for pricing, stock, or lifecycle information?

Click below to explore more details on WIN SOURCE:

-  [View R-78B12-1.0L on WIN SOURCE](#)
-  [Recom Power Information](#)

## Optimize Your Supply Chain with WIN SOURCE Solutions

-  Global Sourcing Solution
-  Obsolete Management
-  Cost Control Management
-  Shortage Management
-  Alternative Solution
-  Excess Inventory Management