



# QPA2640T

## 20 – 40 GHz 8 Watt GaN Power Amplifier

### Product Overview

Qorvo's QPA2640T is a high power MMIC amplifier fabricated on Qorvo's production 0.15 um GaN on SiC process (QGaN15), mounted to a high thermal conductivity tab. The QPA2640T operates from 20 – 40 GHz, provides 8 W of saturated output power with 12 dB of large signal gain and 12% power-added efficiency.

To simplify system integration, the QPA2640T is fully matched to 50 ohms with integrated DC blocking caps on both I/O ports.

The QPA2640T is ideal for supporting communications and radar applications in both commercial and military markets.

The QPA2640T is 100% DC and RF tested on-wafer to ensure compliance to electrical specifications.

Lead-free and RoHS compliant



### Key Features

- Frequency Range: 20 – 40 GHz
- $P_{SAT}$  ( $P_{IN} = 27$  dBm): 39 dBm
- PAE ( $P_{IN} = 27$  dBm): 12 %
- Power Gain ( $P_{IN} = 27$  dBm): 12 dB
- Small Signal Gain: 22 dB
- Return Losses: > 7 dB
- Bias:  $V_D = 18$  V,  $I_{DQ} = 2040$  mA,  $V_G \approx -2.3$  V typ.
- Dimensions: 3.58 x 6.05 x 0.33 mm

*Performance is typical across frequency. Please reference electrical specification table and data plots for more details.*

### Functional Block Diagram

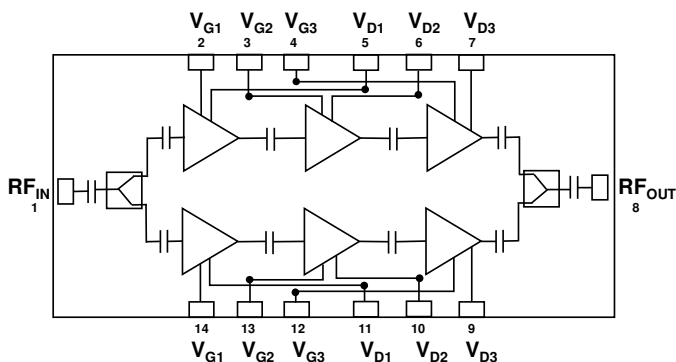

### Applications

- Communications
- Radar
- Point-to-Point Radio
- Electronic Warfare

### Ordering Information

Part No.	Description
QPA2640T	20 – 40 GHz 8 Watt GaN Amplifier
QPA2640DEVB01	Evaluation Board for QPA2640T



### Absolute Maximum Ratings

Parameter	Value / Range
Drain Voltage ( $V_D$ )	29.5 V
Gate Voltage Range ( $V_G$ )	-4 V to 0 V
Drain Current, stage 1 ( $I_{D1}$ )	1440 mA
Drain Current, stage 2 ( $I_{D2}$ )	2030 mA
Drain Current, stage 3 ( $I_{D3}$ )	3200 mA
Drain Current, total ( $I_D$ )	6670 mA
Gate Current ( $I_G$ )	See chart p. 17
Power Dissipation ( $P_{DISS}$ ), $T_{BASE} = 85\text{ }^\circ\text{C}$	74 W
Input Power ( $P_{IN}$ ), 50 $\Omega$ , CW, $V_D = 18\text{ V}$ , $I_D = 2040\text{ mA}$ , $T_{BASE} = 85\text{ }^\circ\text{C}$	33 dBm
Input Power ( $P_{IN}$ ), 3:1 VSWR, CW, $V_D = 18\text{ V}$ , $I_D = 2040\text{ mA}$ , $T_{BASE} = 85\text{ }^\circ\text{C}$	33 dBm
Mounting Temperature (30 seconds)	320 $^\circ\text{C}$
Storage Temperature	-55 to +150 $^\circ\text{C}$

Operation of this device outside the parameter ranges given above may cause permanent damage. These are stress ratings only, and functional operation of the device at these conditions is not implied.

### Recommended Operating Conditions

Parameter	Min	Typ.	Max	Units
Drain Voltage ( $V_D$ )		18	20	V
Drain Current, Quiescent ( $I_D$ )		2040		mA
Drain Current, RF ( $I_{D\_Drive}$ )	See charts p. 6, 10, 13, 16			mA
Gate Voltage Typ. Range ( $V_G$ )	-1.7 to -2.9			V
Gate Current, RF ( $I_{G\_Drive}$ )	See charts p. 6			mA
Input Power @ Saturation, ( $P_{IN}$ )	$T_{BASE} -40\text{ }^\circ\text{C}$ :	27		dBm
	$T_{BASE} +25\text{ }^\circ\text{C}$ :	27		
	$T_{BASE} +85\text{ }^\circ\text{C}$ :	30		
Operating Temp. Range ( $T_{BASE}^{1/}$ )	-40		+85	$^\circ\text{C}$

1/  $T_{BASE}$  is back side of QPA2640T

Electrical specifications are measured at specified test conditions. Specifications are not guaranteed over all recommended operating conditions.

### Electrical Specifications

Parameter	Conditions <sup>(1)</sup> <sup>(2)</sup>	Min	Typ.	Max	Units
Operational Frequency Range		20		40	GHz
Output Power at Saturation, $P_{SAT}$	$P_{IN} = +27\text{ dBm}$		39		dBm
Power Added Efficiency, PAE	$P_{IN} = +27\text{ dBm}$		12		%
Large Signal Gain	$P_{IN} = +27\text{ dBm}$		12		dB
Small Signal Gain, $S_{21}$			22		dB
Input Return Loss, IRL			> 7		dB
Output Return Loss, ORL			> 7		dB
$P_{SAT}$ Temperature Coefficient	$T_{DIFF} = -40\text{ }^\circ\text{C}$ to $+85\text{ }^\circ\text{C}$ ; $P_{IN} = +27\text{ dBm}$		-0.03		dBm/ $^\circ\text{C}$
$S_{21}$ Temperature Coefficient	$T_{DIFF} = -40\text{ }^\circ\text{C}$ to $+85\text{ }^\circ\text{C}$		-0.10		dB/ $^\circ\text{C}$

Notes:

1. Test conditions unless otherwise noted: CW,  $V_D = 18\text{ V}$ ,  $I_D = 2040\text{ mA}$ ,  $V_G = -2.3\text{ V} \pm 0.6\text{ V}$  typical,  $T_{BASE} = +25\text{ }^\circ\text{C}$ ,  $Z_0 = 50\text{ }\Omega$
2.  $T_{BASE}$  is back side of QPA2640T

Performance Plots – Small Signal

Test conditions, unless otherwise noted: CW,  $V_D = 18\text{ V}$ ,  $I_{DQ} = 2040\text{ mA}$ ,  $T_{BASE} = 25\text{ }^\circ\text{C}$  ( $T_{BASE}$  is backside of QPA2640T)

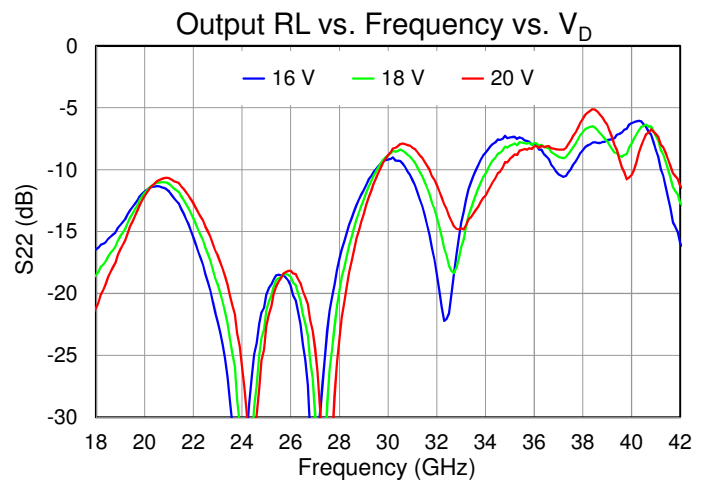
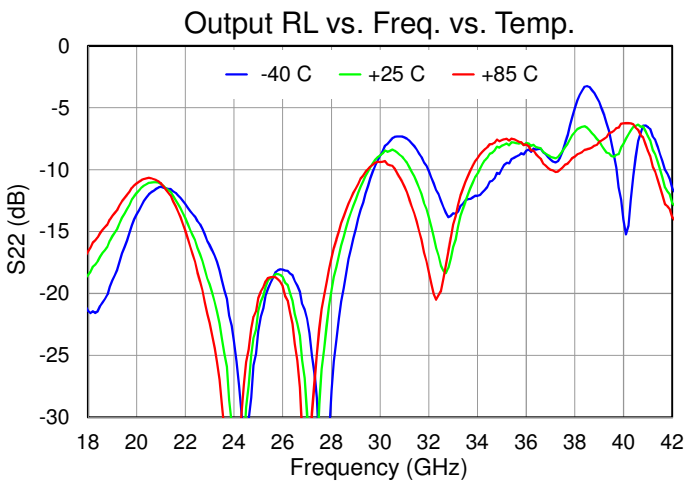
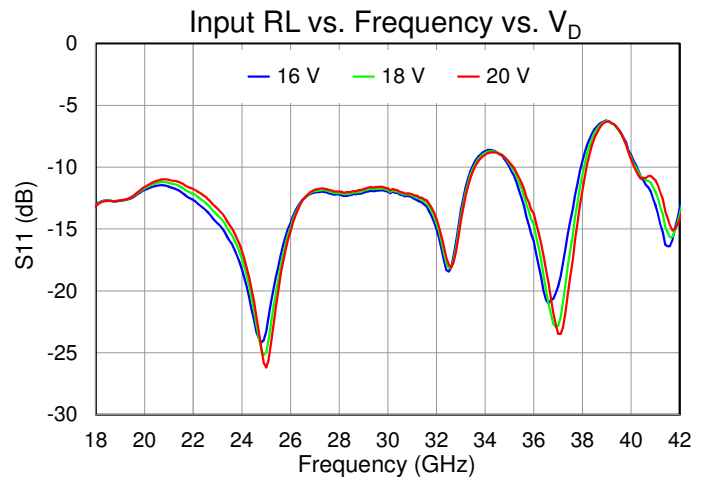
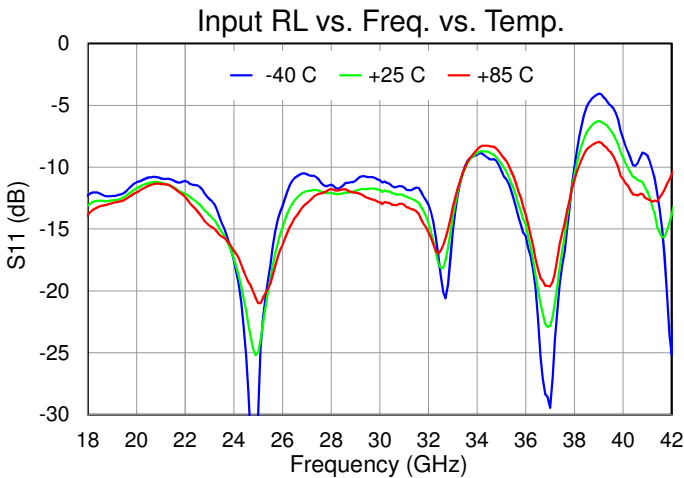
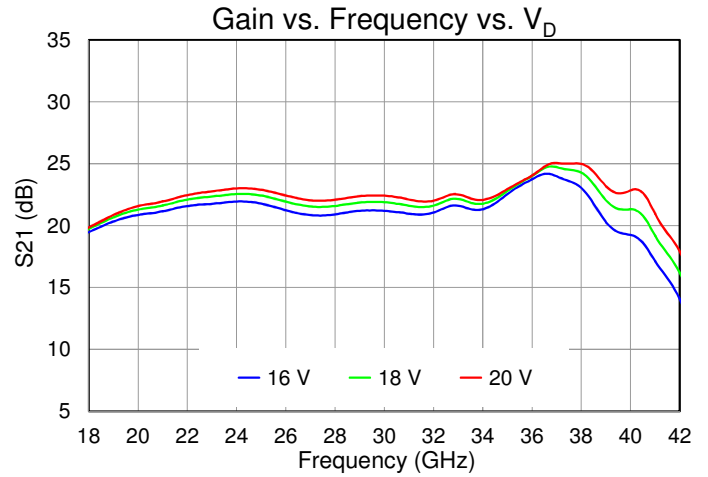
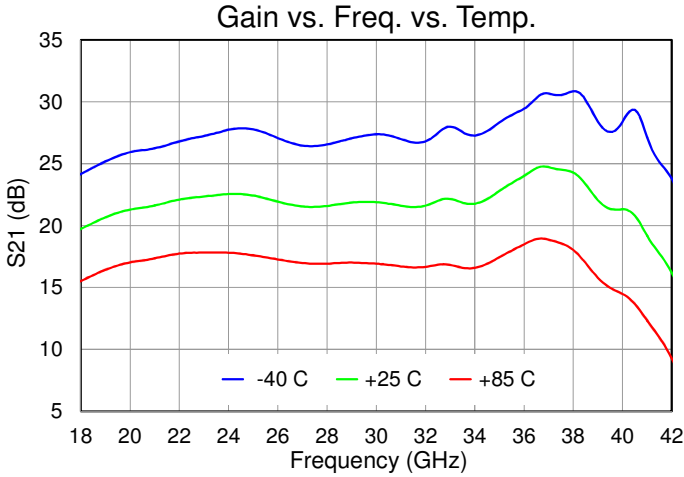

**Performance Plots – Small Signal**

Test conditions, unless otherwise noted: CW,  $V_D = 18\text{ V}$ ,  $I_{DQ} = 2040\text{ mA}$ ,  $T_{BASE} = 25\text{ }^\circ\text{C}$  ( $T_{BASE}$  is backside of QPA2640T)

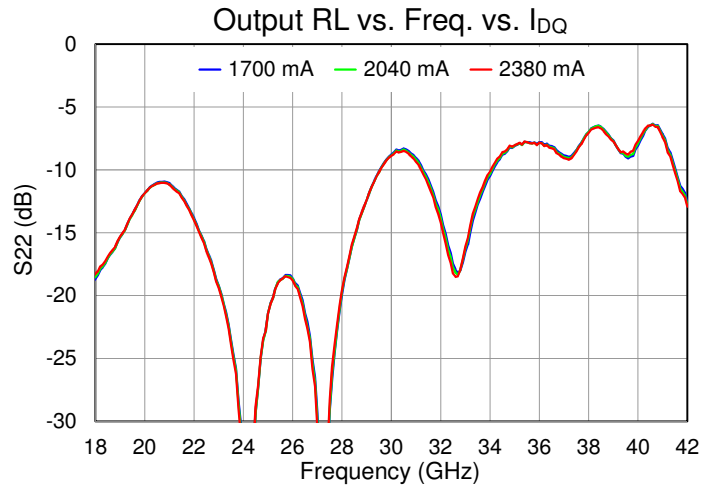
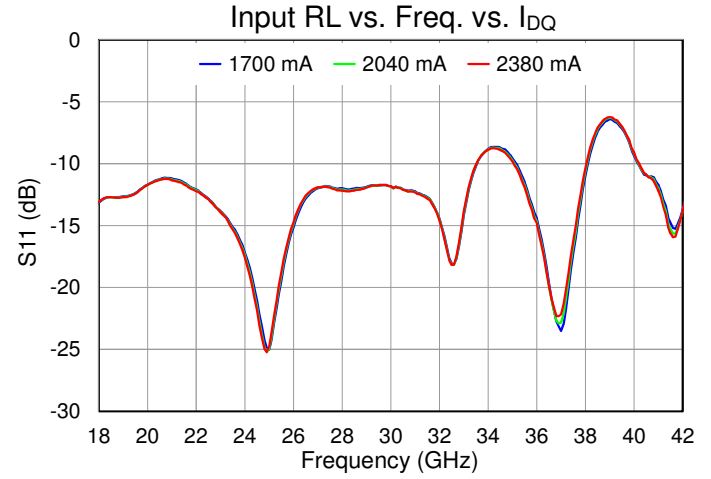
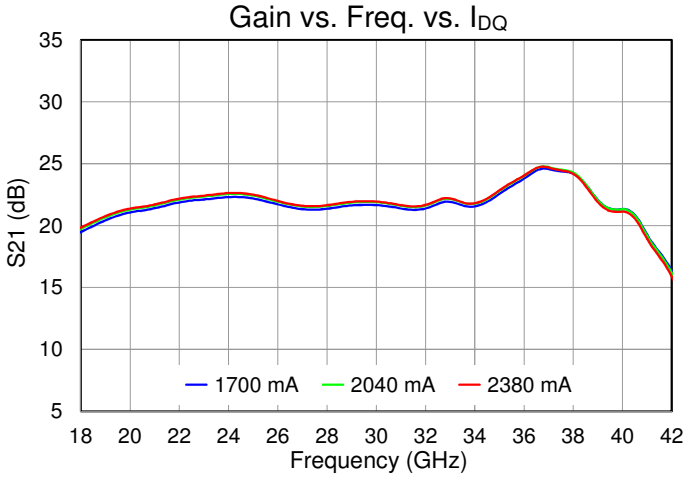

## Performance Plots – Large Signal

Test conditions, unless otherwise noted: CW,  $V_D = 18\text{ V}$ ,  $I_{DQ} = 2040\text{ mA}$ ,  $P_{IN} = 27\text{ dBm}$ ,  $T_{BASE} = 25\text{ }^\circ\text{C}$  ( $T_{BASE}$  is backside of QPA2640T)

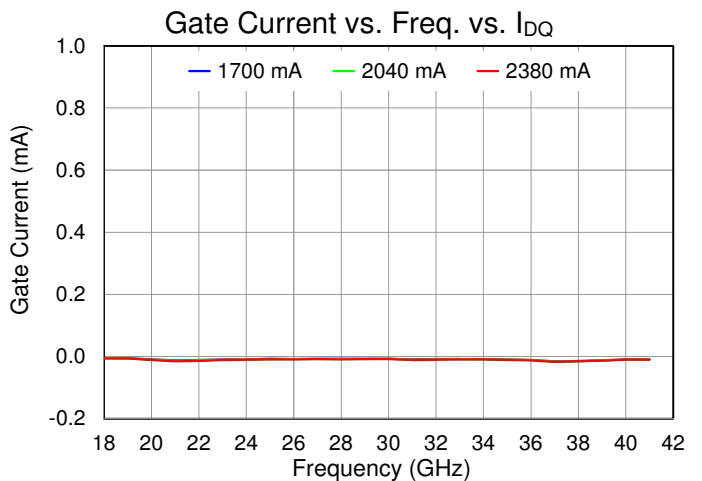
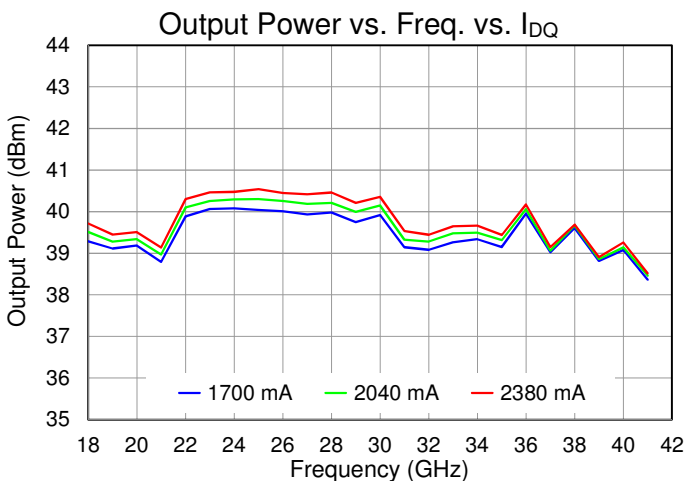
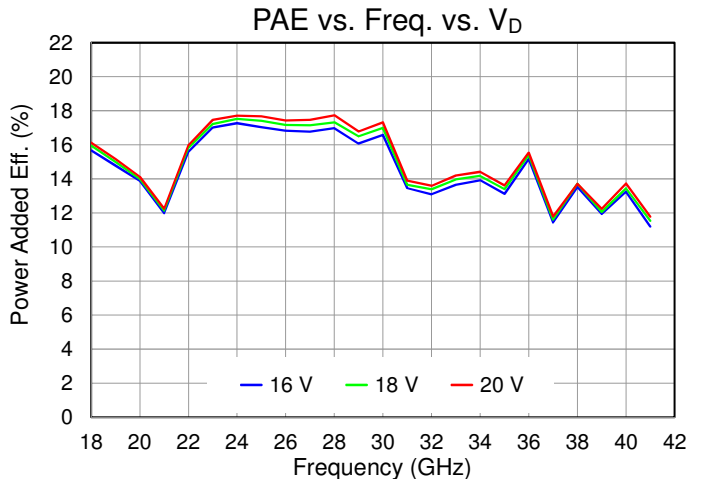
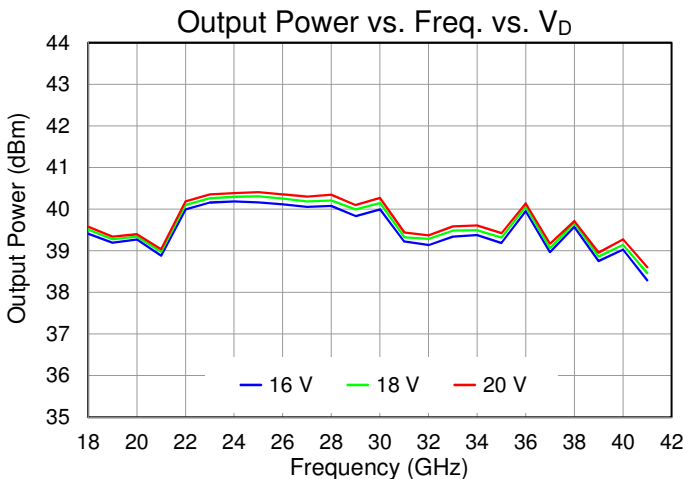
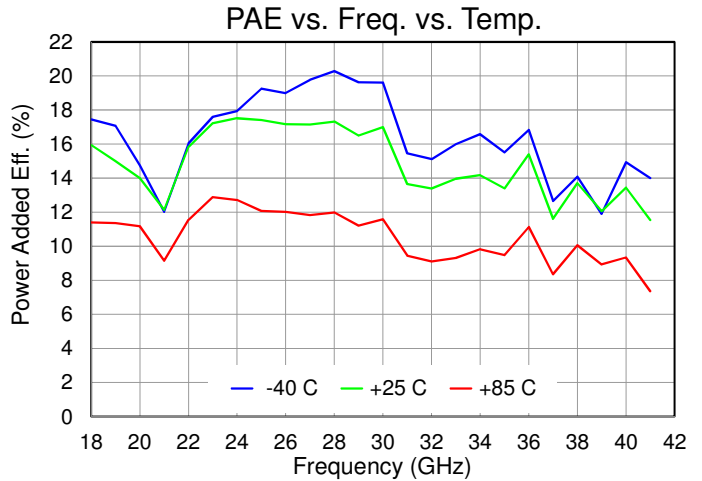
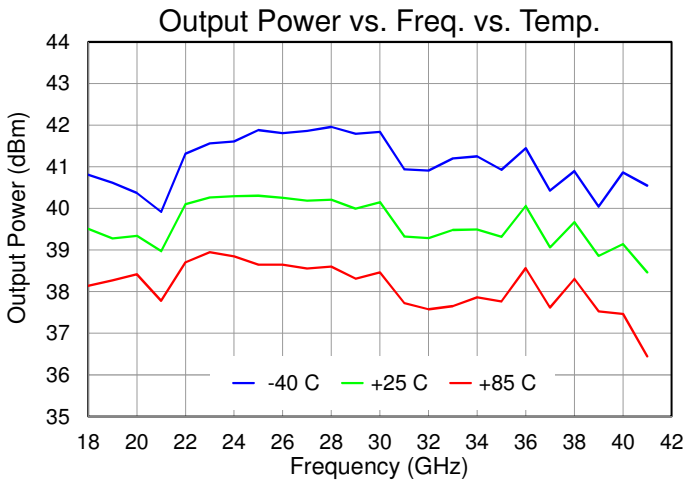

## Performance Plots – Large Signal

Test conditions, unless otherwise noted: CW,  $V_D = 18\text{ V}$ ,  $I_{DQ} = 2040\text{ mA}$ ,  $P_{IN} = 27\text{ dBm}$ ,  $T_{BASE} = 25\text{ }^\circ\text{C}$  ( $T_{BASE}$  is backside of QPA2640T)

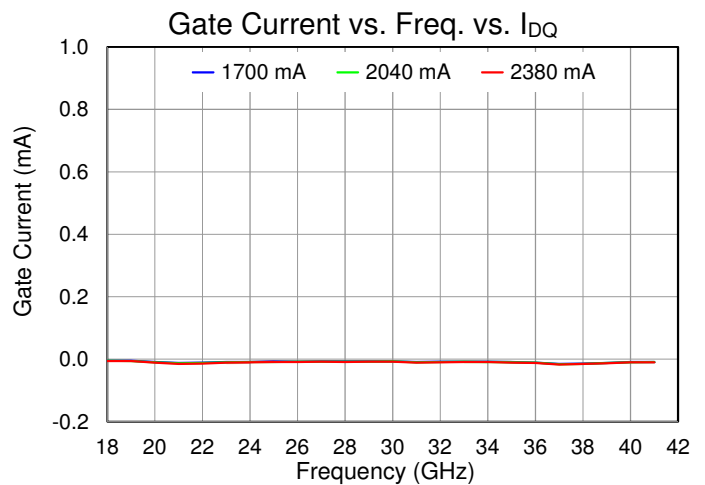
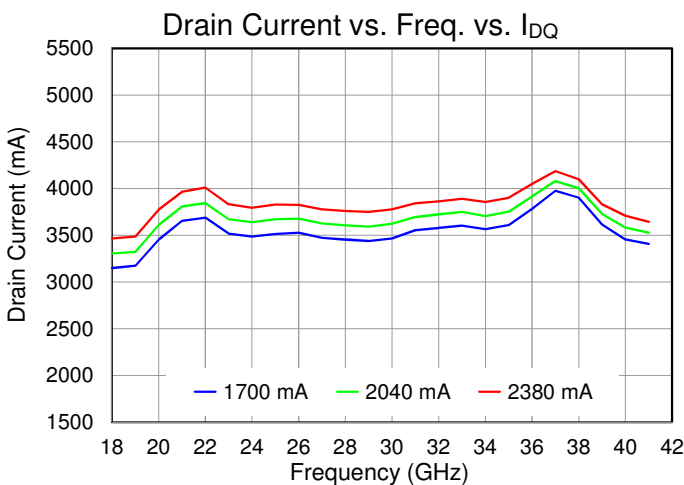
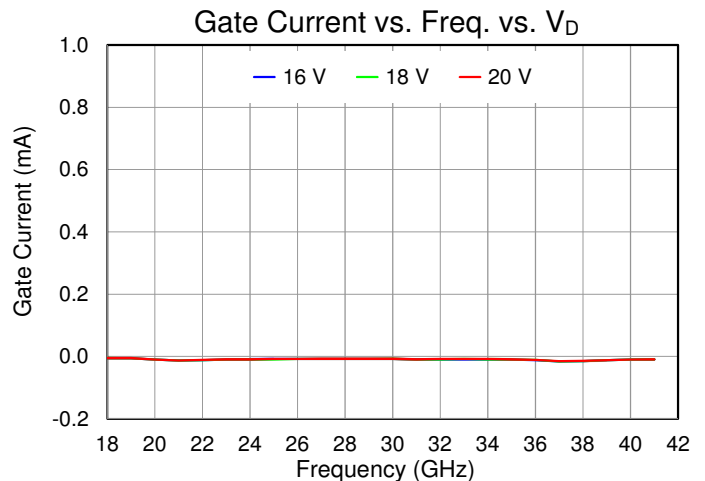
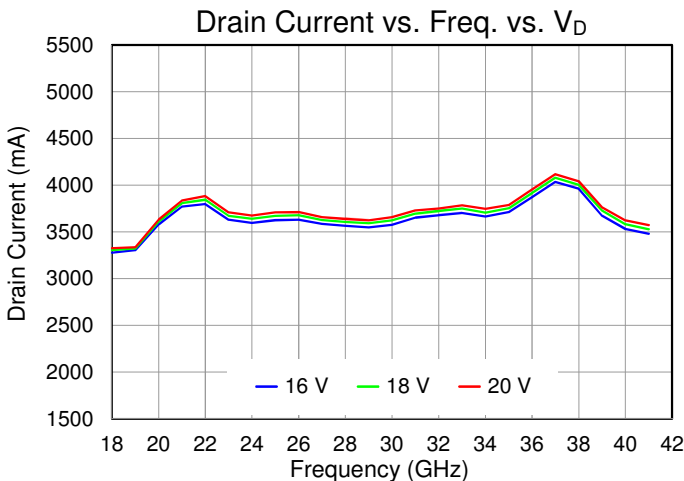
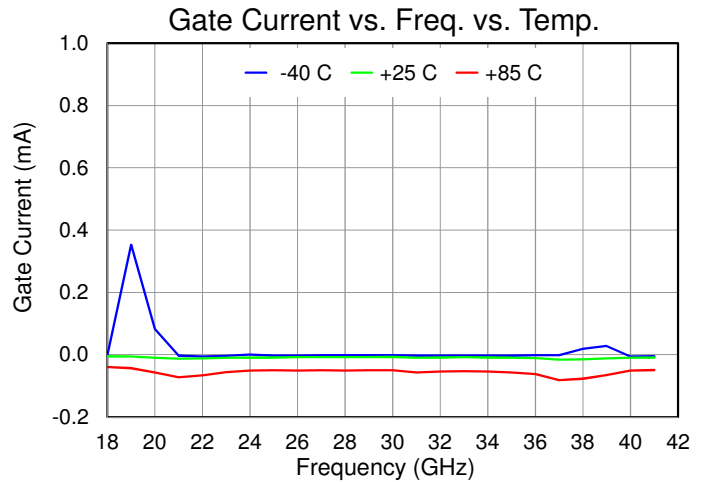
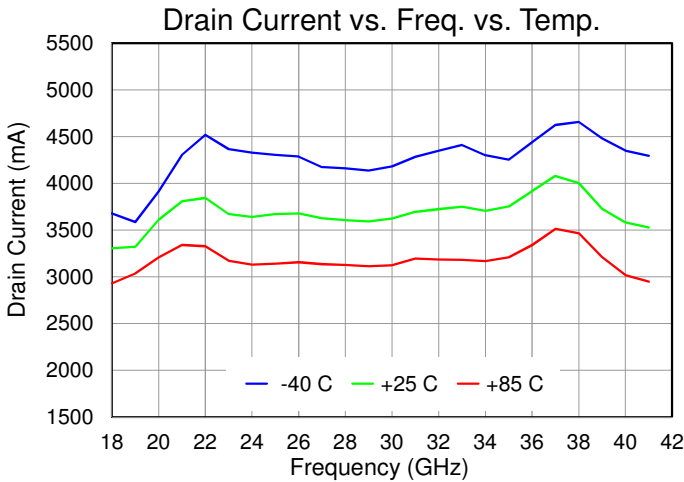

## Performance Plots – Large Signal

Test conditions, unless otherwise noted: CW,  $V_D = 18\text{ V}$ ,  $I_{DQ} = 2040\text{ mA}$ ,  $P_{IN} = 27\text{ dBm}$ ,  $T_{BASE} = 25\text{ }^\circ\text{C}$  ( $T_{BASE}$  is backside of QPA2640T)

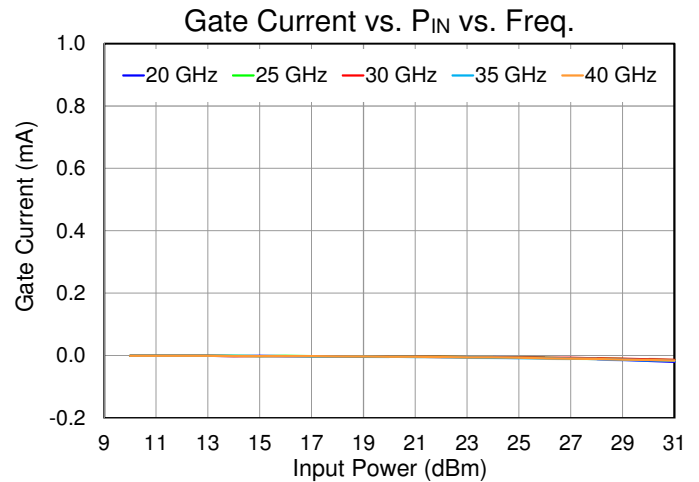
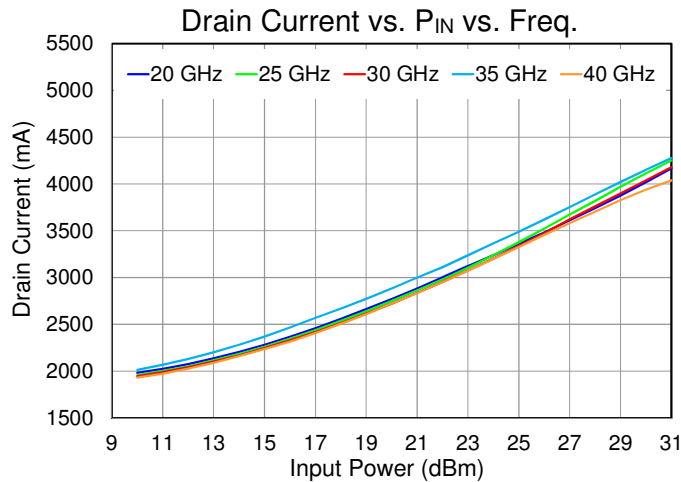
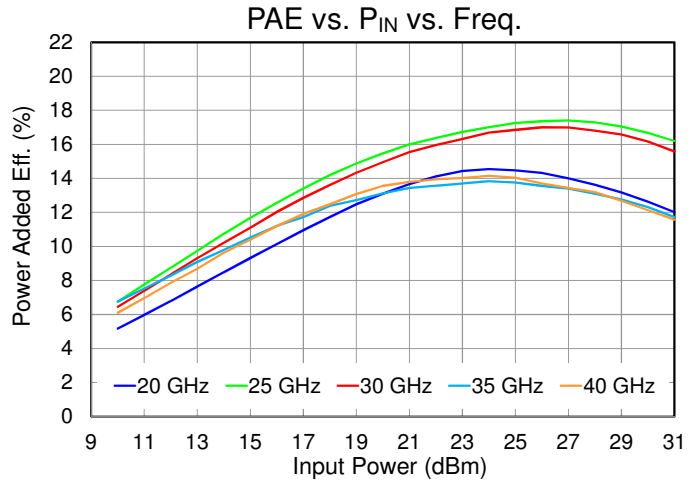
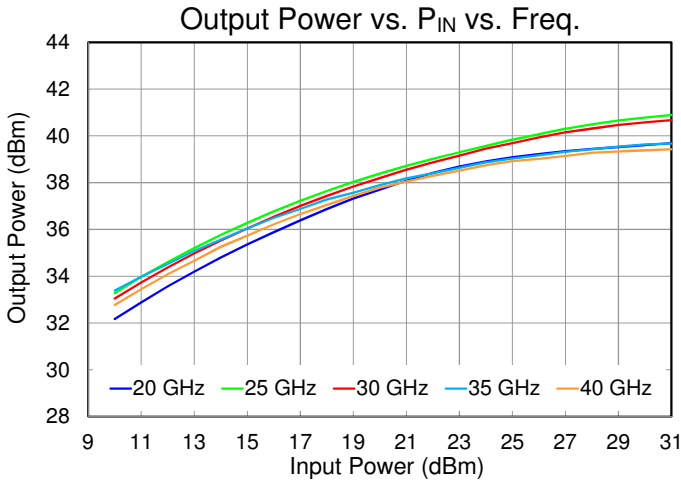

**Performance Plots – Large Signal**

Test conditions, unless otherwise noted: CW,  $V_D = 18\text{ V}$ ,  $I_{DQ} = 2040\text{ mA}$ ,  $P_{IN} = 27\text{ dBm}$ ,  $T_{BASE} = 25\text{ }^\circ\text{C}$  ( $T_{BASE}$  is backside of QPA2640T)

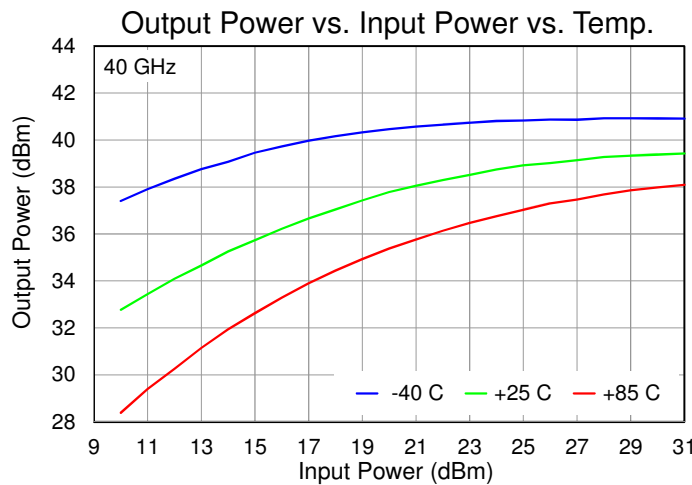
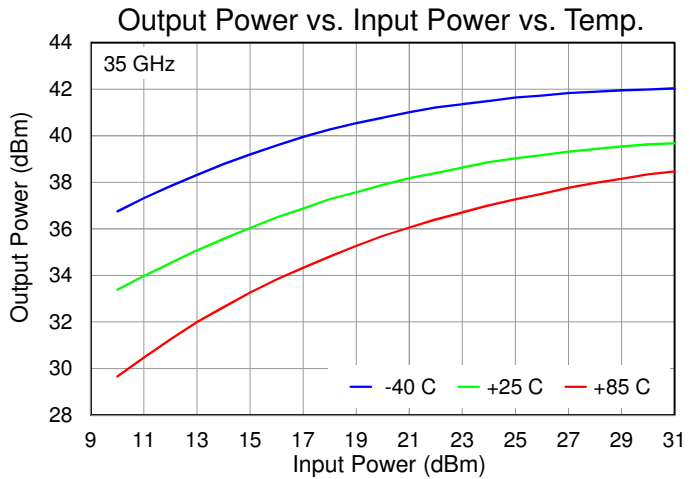
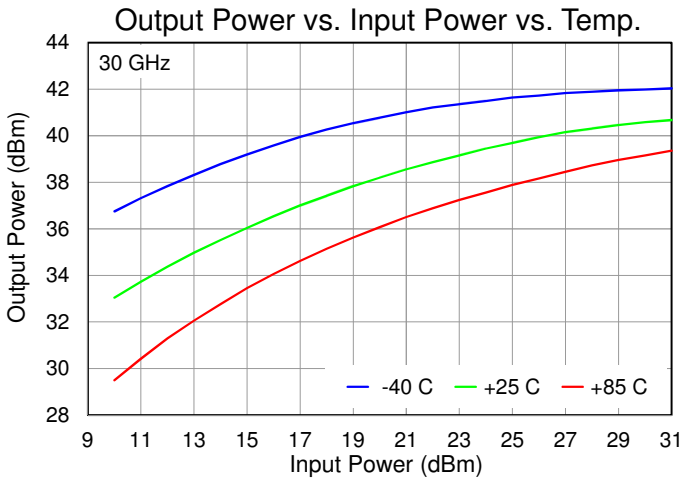
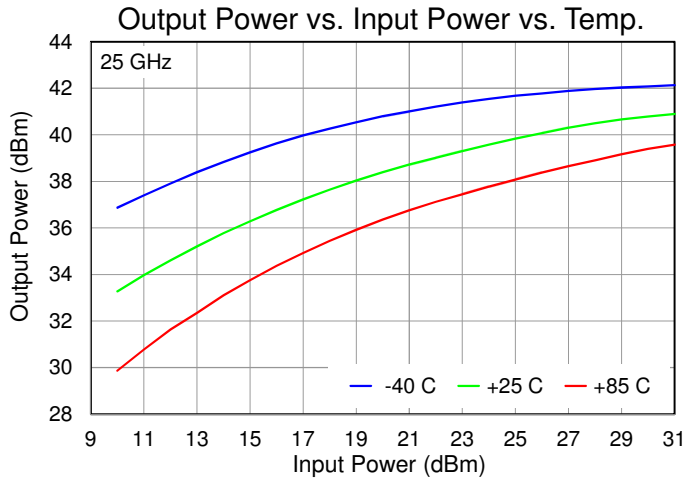
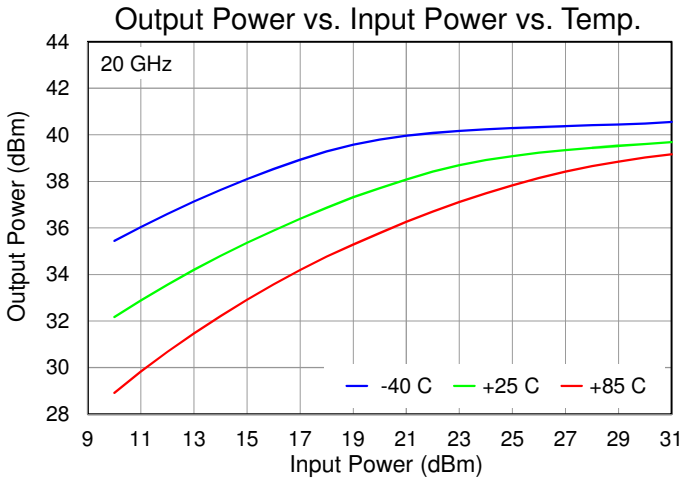

**Performance Plots – Large Signal**

Test conditions, unless otherwise noted: CW,  $V_D = 18\text{ V}$ ,  $I_{DQ} = 2040\text{ mA}$ ,  $P_{IN} = 27\text{ dBm}$ ,  $T_{BASE} = 25\text{ }^\circ\text{C}$  ( $T_{BASE}$  is backside of QPA2640T)

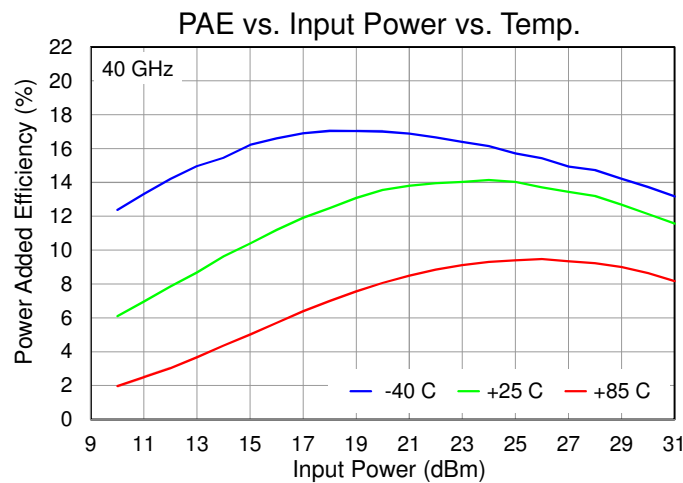
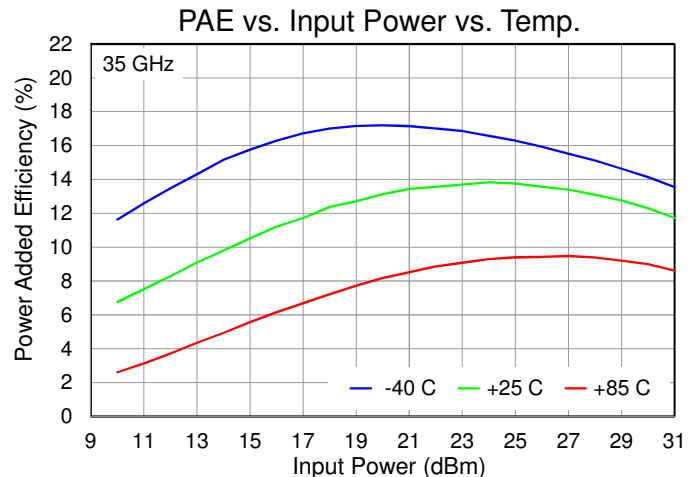
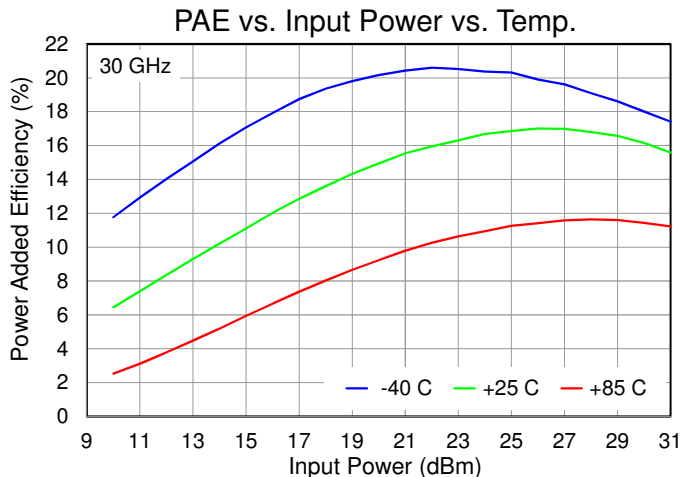
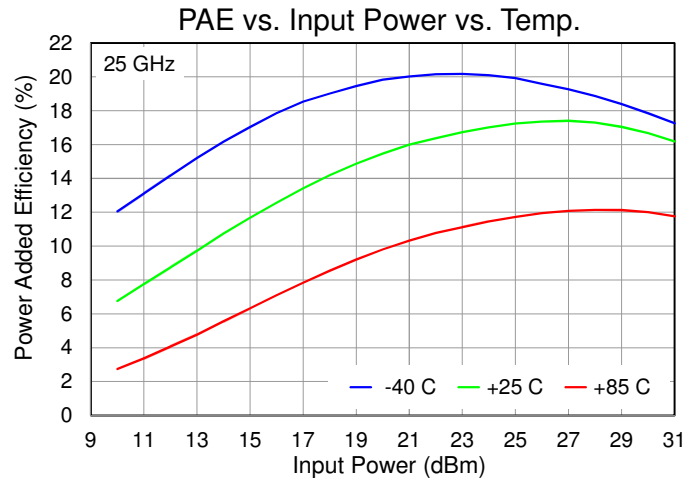
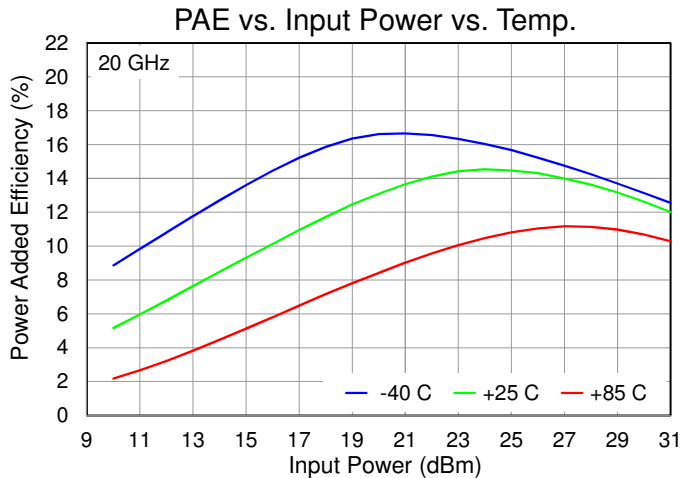

**Performance Plots – Large Signal**

Test conditions, unless otherwise noted: CW,  $V_D = 18\text{ V}$ ,  $I_{DQ} = 2040\text{ mA}$ ,  $P_{IN} = 27\text{ dBm}$ ,  $T_{BASE} = 25\text{ }^\circ\text{C}$  ( $T_{BASE}$  is backside of QPA2640T)

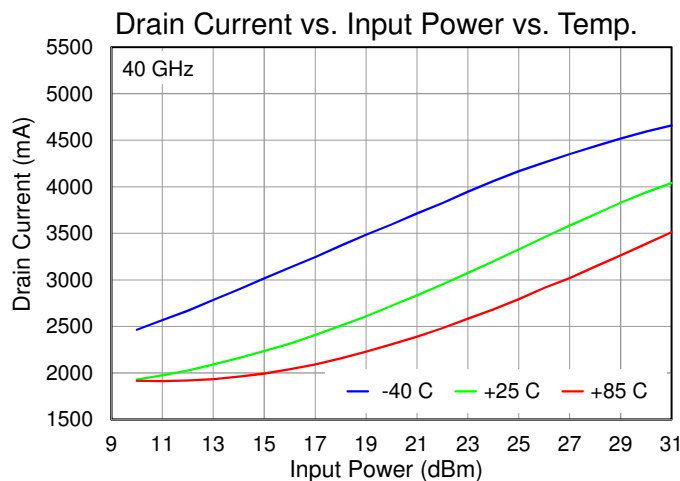
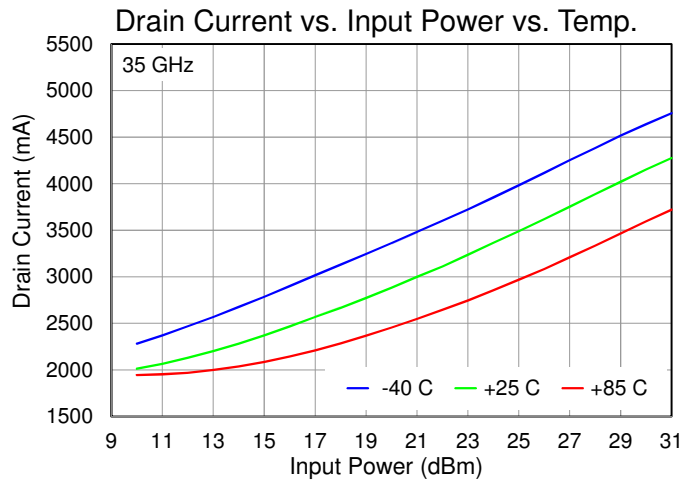
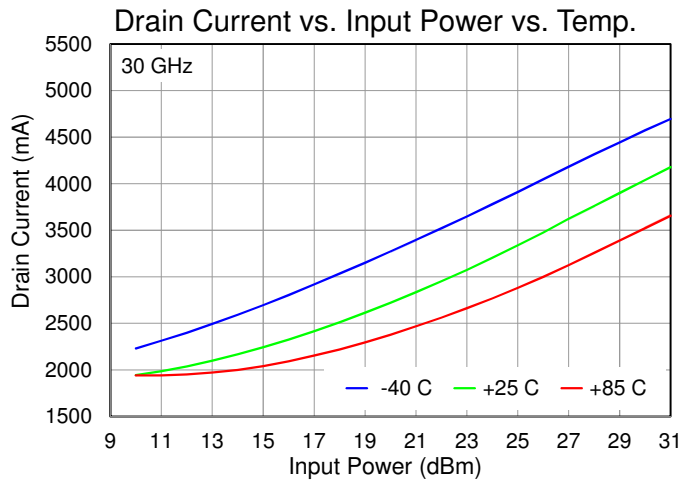
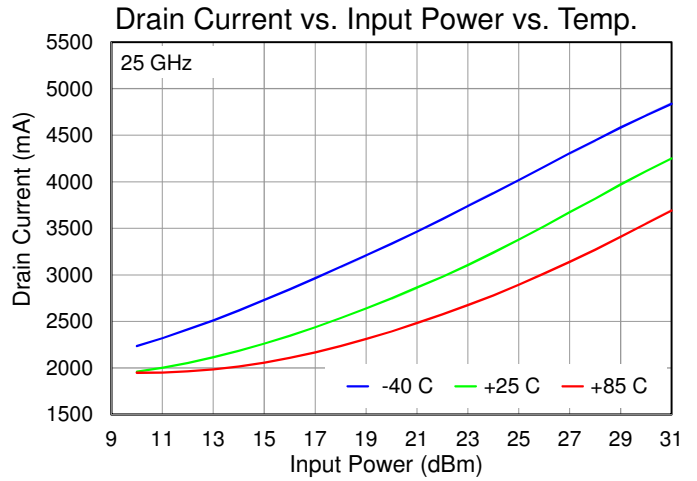
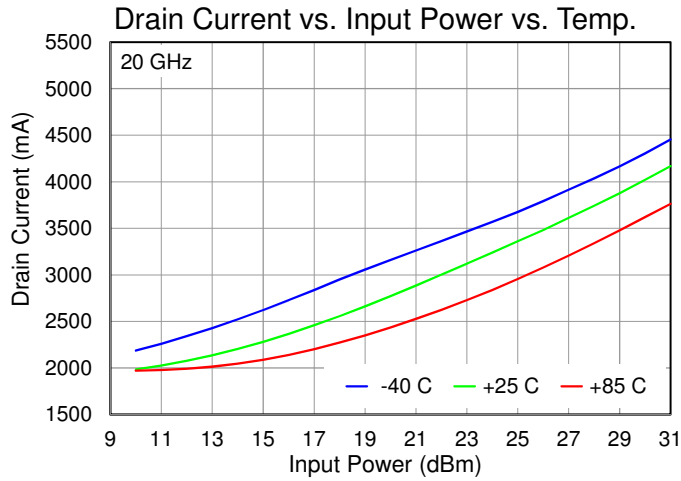

Performance Plots – Large Signal

Test conditions, unless otherwise noted: CW,  $V_D = 18\text{ V}$ ,  $I_{DQ} = 2040\text{ mA}$ ,  $P_{IN} = 27\text{ dBm}$ ,  $T_{BASE} = 25\text{ }^\circ\text{C}$  ( $T_{BASE}$  is backside of QPA2640T)

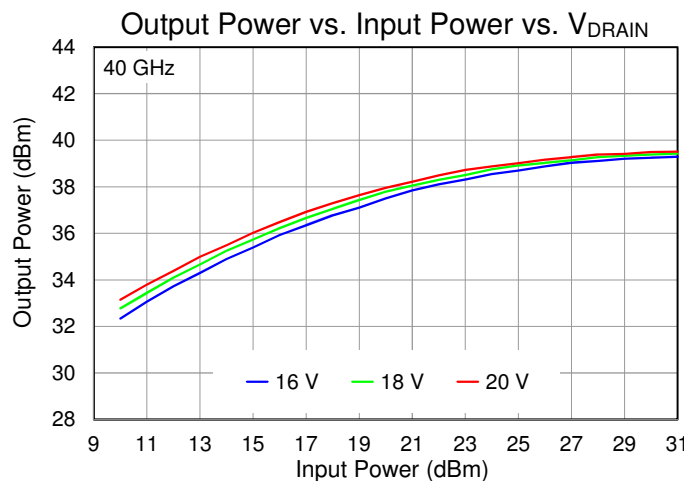
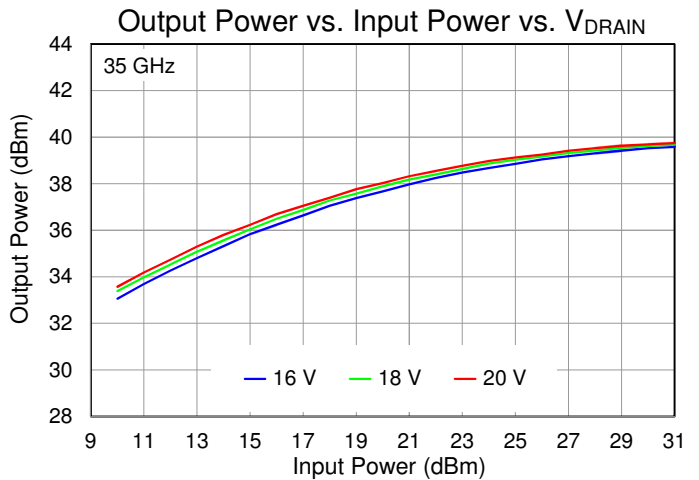
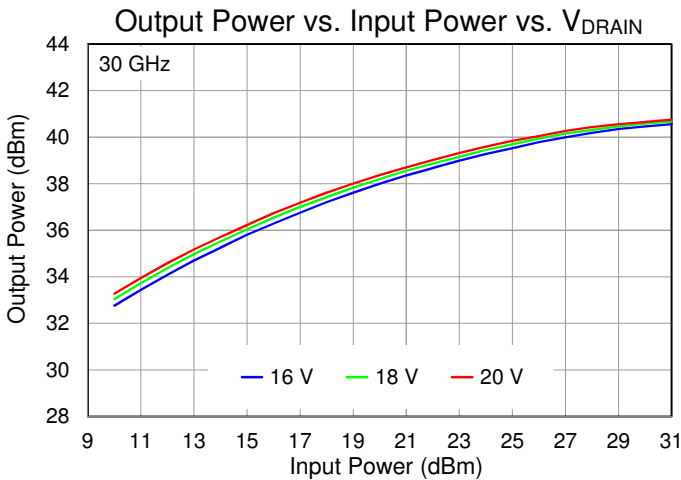
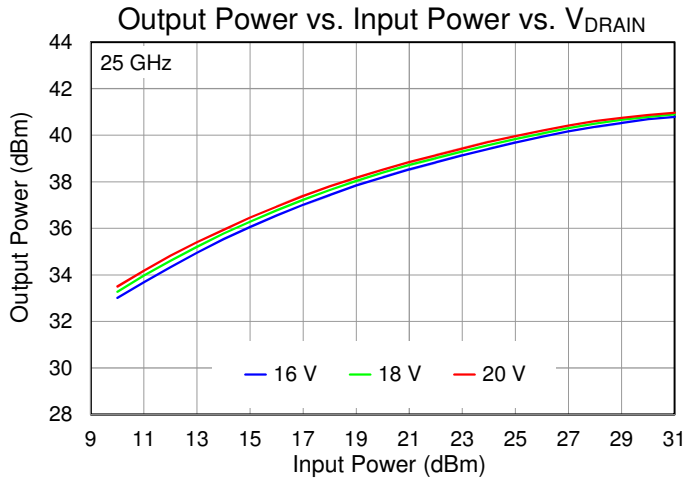
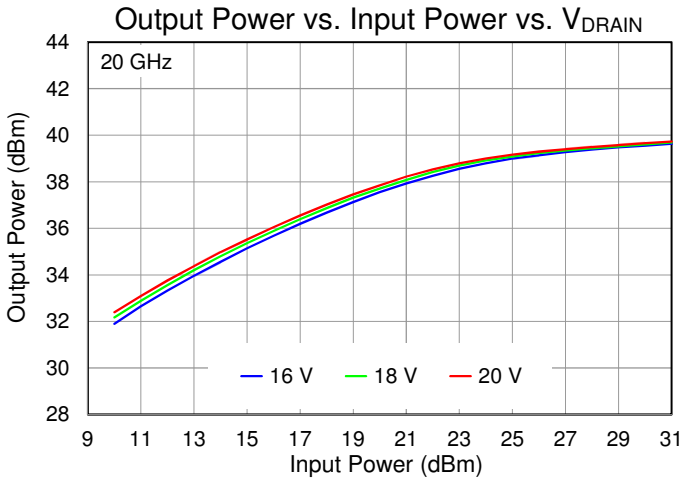

## Performance Plots – Large Signal

Test conditions, unless otherwise noted: CW,  $V_D = 18\text{ V}$ ,  $I_{DQ} = 2040\text{ mA}$ ,  $P_{IN} = 27\text{ dBm}$ ,  $T_{BASE} = 25\text{ }^\circ\text{C}$  ( $T_{BASE}$  is backside of QPA2640T)

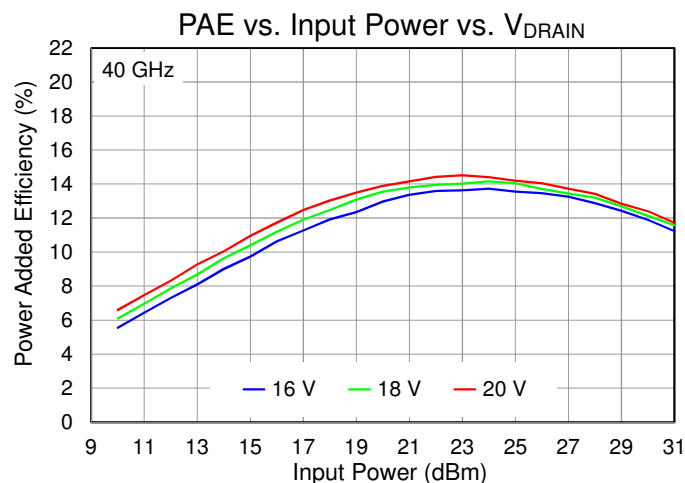
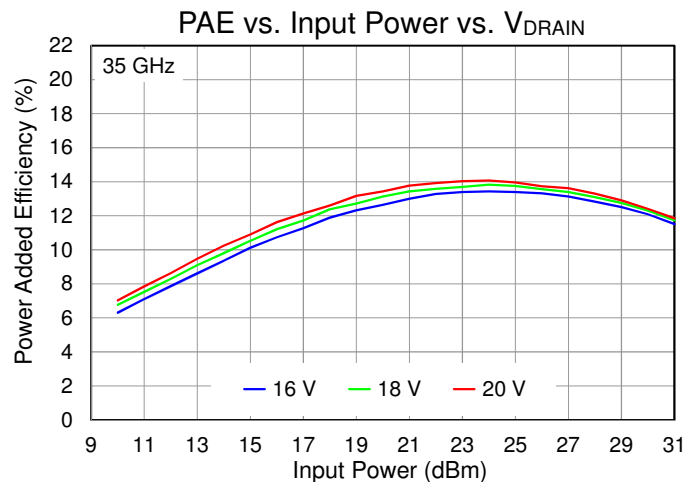
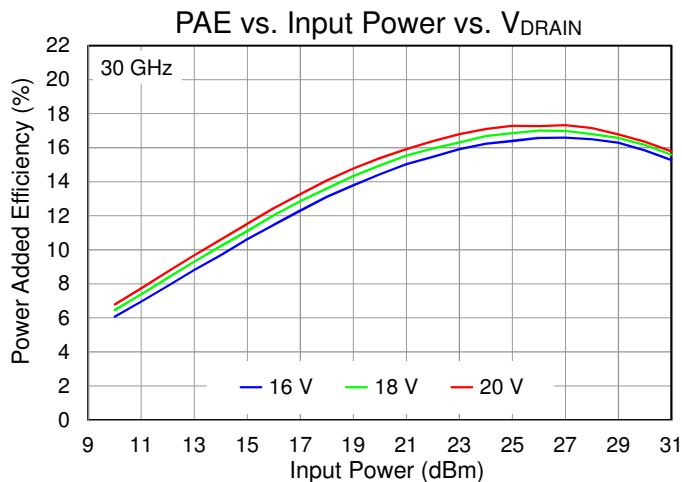
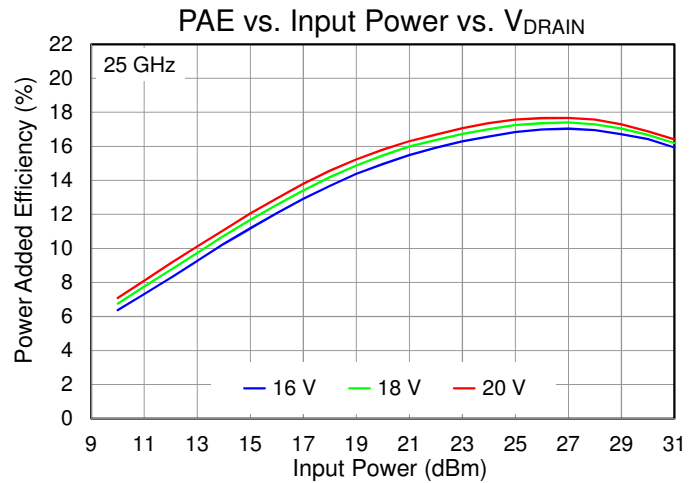
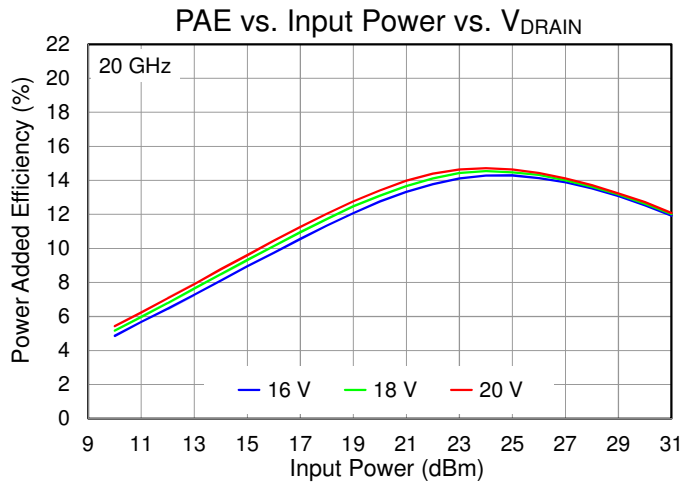

Performance Plots – Large Signal

Test conditions, unless otherwise noted: CW,  $V_D = 18\text{ V}$ ,  $I_{DQ} = 2040\text{ mA}$ ,  $P_{IN} = 27\text{ dBm}$ ,  $T_{BASE} = 25\text{ °C}$  ( $T_{BASE}$  is backside of QPA2640T)

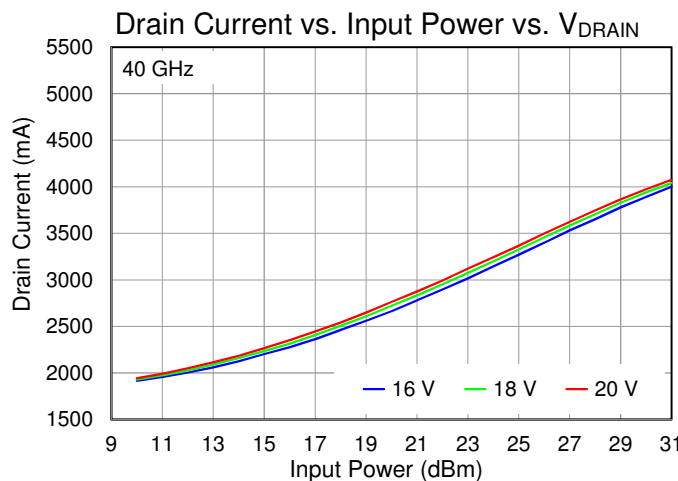
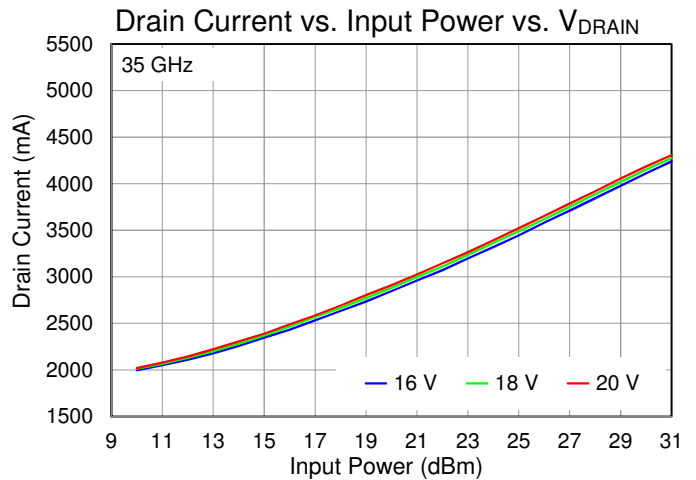
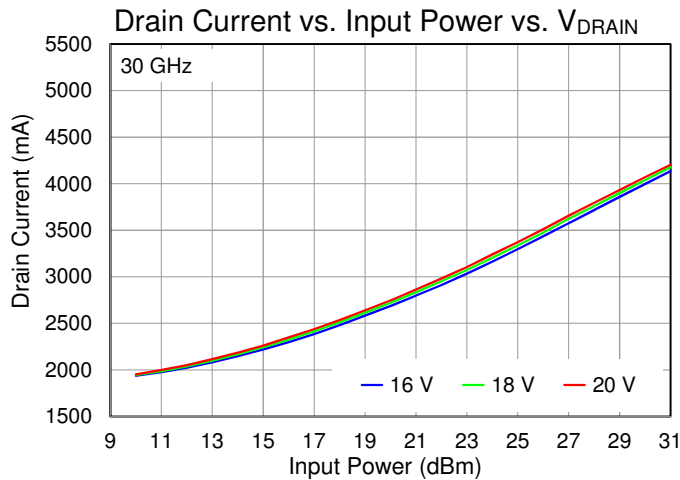
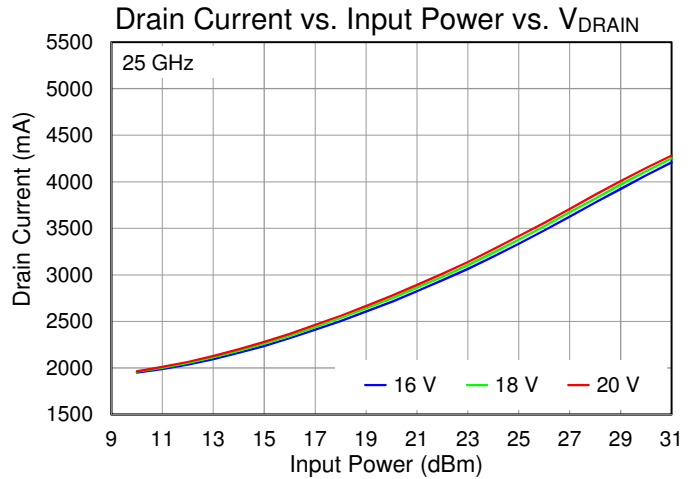
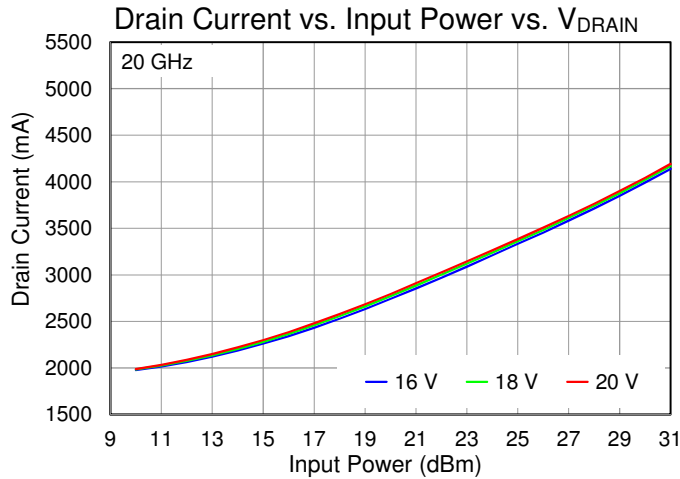

Performance Plots – Large Signal

Test conditions, unless otherwise noted: CW,  $V_D = 18\text{ V}$ ,  $I_{DQ} = 2040\text{ mA}$ ,  $P_{IN} = 27\text{ dBm}$ ,  $T_{BASE} = 25\text{ }^\circ\text{C}$  ( $T_{BASE}$  is backside of QPA2640T)

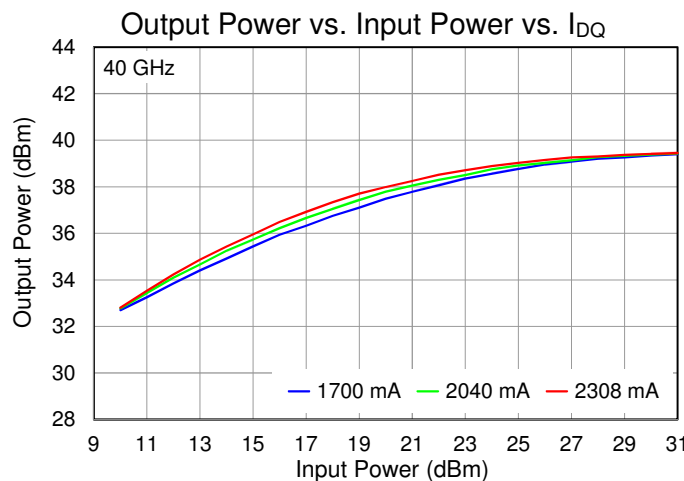
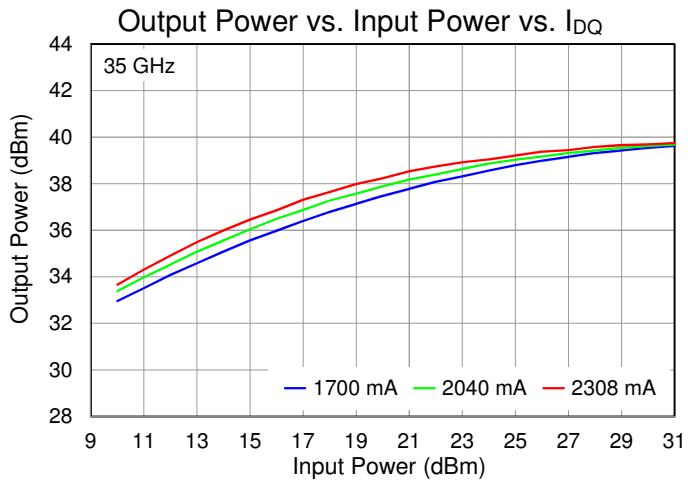
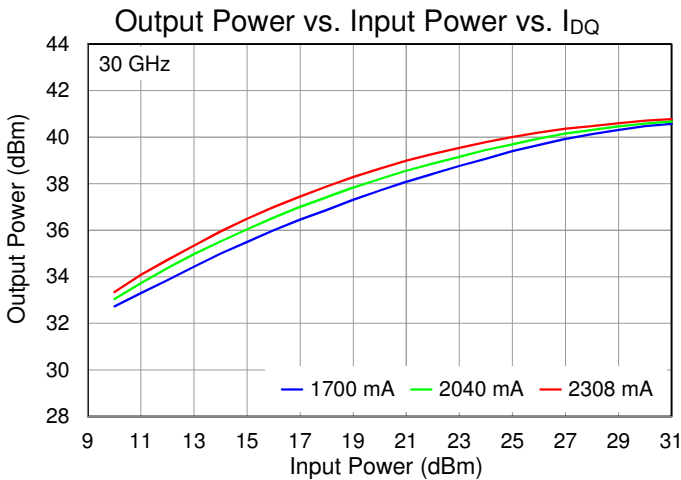
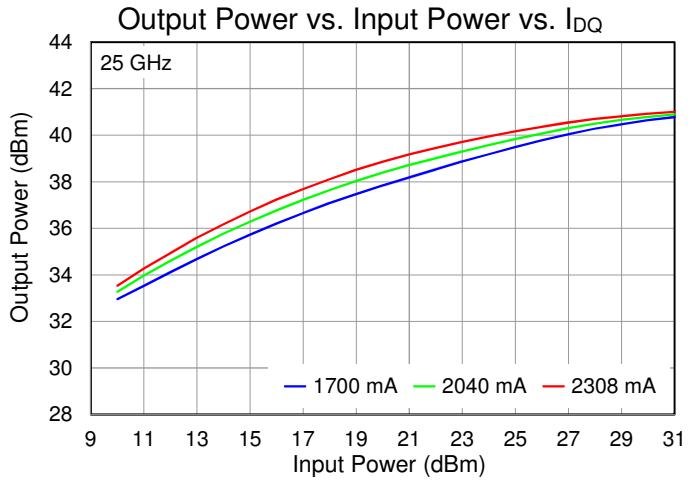
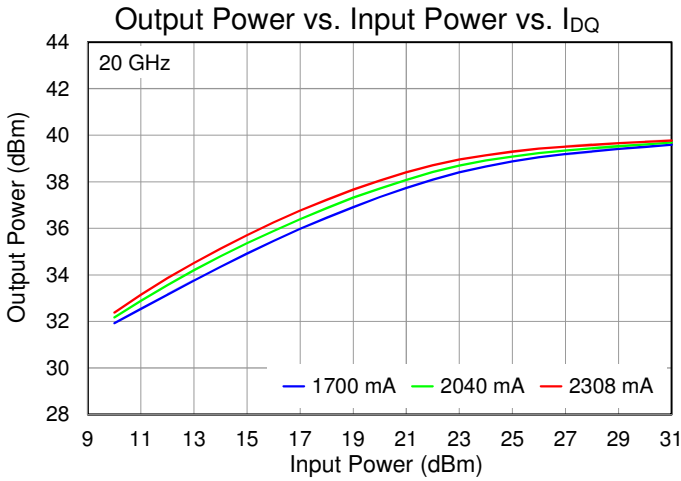

Performance Plots – Large Signal

Test conditions, unless otherwise noted: CW,  $V_D = 18\text{ V}$ ,  $I_{DQ} = 2040\text{ mA}$ ,  $P_{IN} = 27\text{ dBm}$ ,  $T_{BASE} = 25\text{ }^\circ\text{C}$  ( $T_{BASE}$  is backside of QPA2640T)

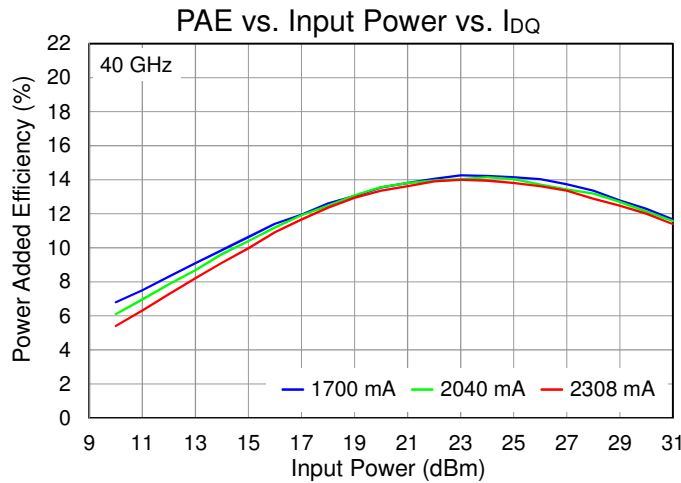
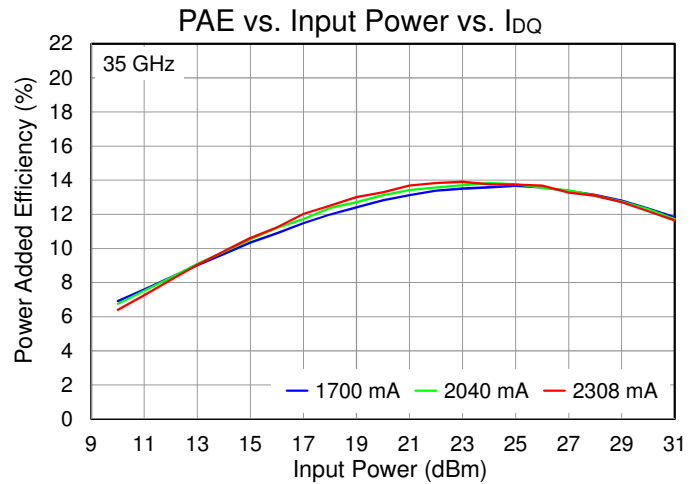
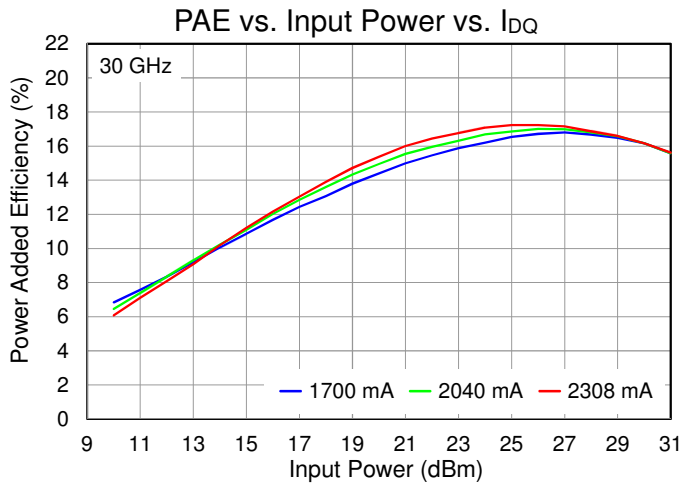
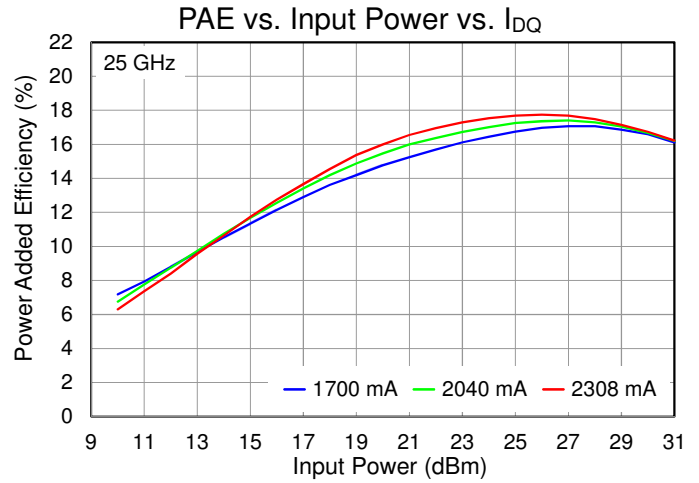
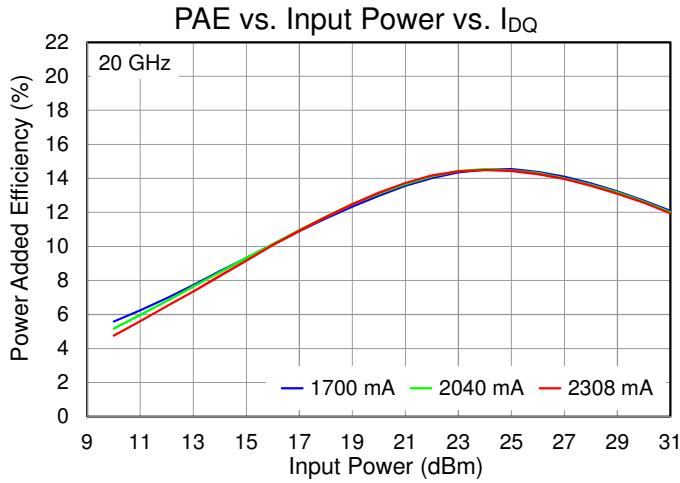

Performance Plots – Large Signal

Test conditions, unless otherwise noted: CW,  $V_D = 18\text{ V}$ ,  $I_{DQ} = 2040\text{ mA}$ ,  $P_{IN} = 27\text{ dBm}$ ,  $T_{BASE} = 25\text{ }^\circ\text{C}$  ( $T_{BASE}$  is backside of QPA2640T)

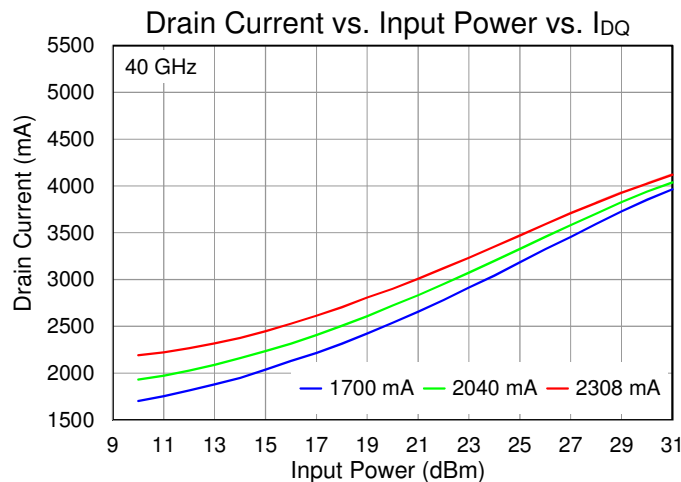
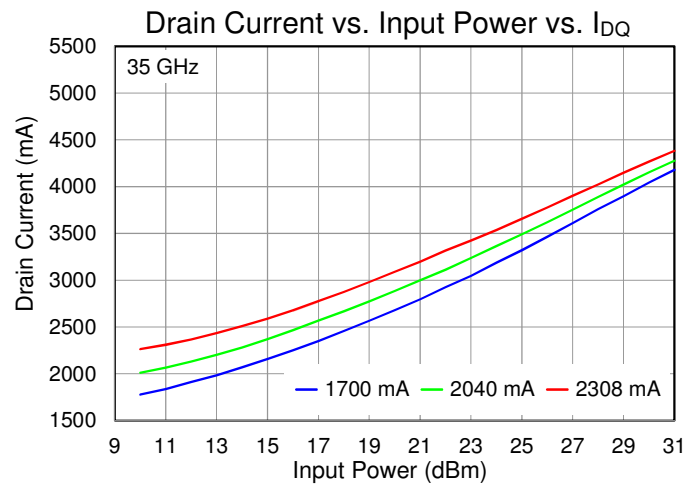
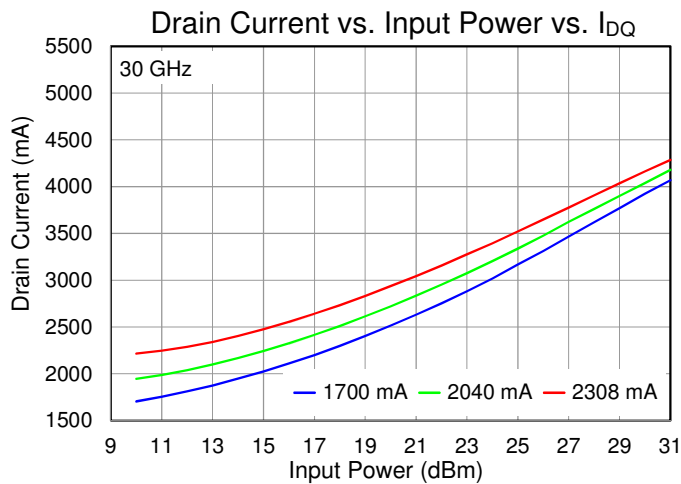
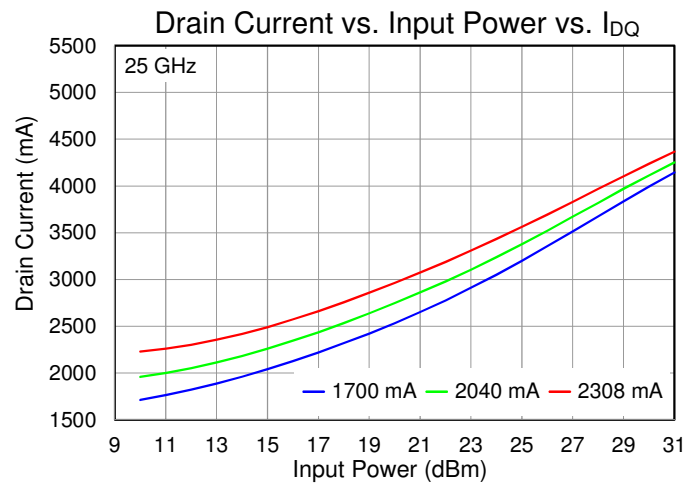
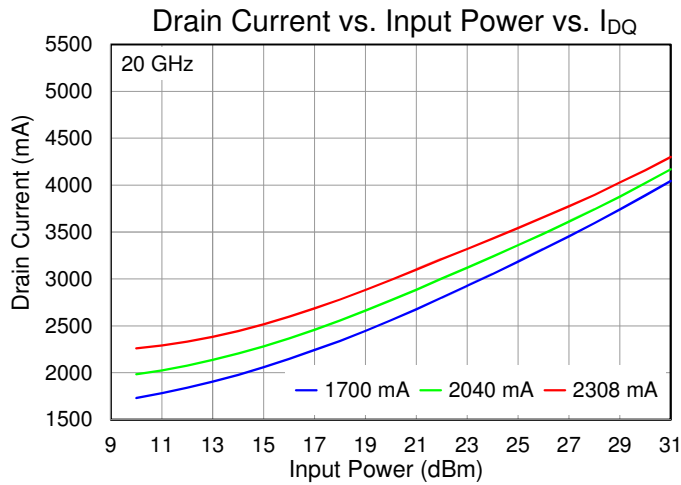

## Thermal and Reliability Information

Parameter	Test Conditions	Value	Units
Thermal Resistance, $\theta_{JC}$ <sup>(1)</sup>	Quiescent	1.17	$^{\circ}C/W$
Channel Temperature, $T_{CH}$ <sup>(2)</sup>	$T_{base} = 85^{\circ}C$ , $V_D = 18 V$ , $I_{DQ} = 2040 mA$ , $P_{DISS} = 36.7 W$	128	$^{\circ}C$
Thermal Resistance, $\theta_{JC}$ <sup>(1)</sup>	CW, $T_{base} = 85^{\circ}C$ , $V_D = 18 V$ , $I_{DQ} = 2040 mA$ , Freq = 37 GHz, $I_{D\_Drive} = 3515 mA$ , $P_{IN} = 27 dBm$ , $P_{OUT} = 37.6 dBm$ , $P_{DISS} = 58 W$	1.50	$^{\circ}C/W$
Channel Temperature, $T_{CH}$ <sup>(2)</sup>		172	$^{\circ}C$

Notes:

1. Thermal resistance determined to the back side of QPA2640T ( $T_{BASE} = 85^{\circ}C$ )
2. Channel temperature indicated is an IR scan equivalent temperature. Thermal resistance is calculated using this value. Additional information can be found in the Qorvo Applications Note "GaN Device TCHMAX Theta-JC and Reliability Estimates," located here <https://www.qorvo.com/products/d/da006480>

## Dissipated Power and Maximum Gate Current

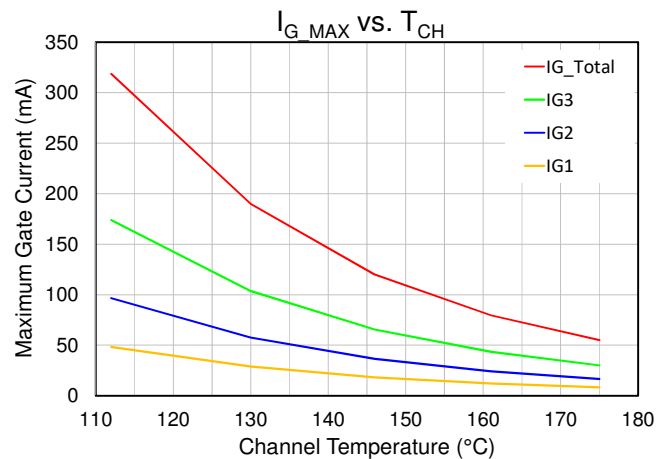
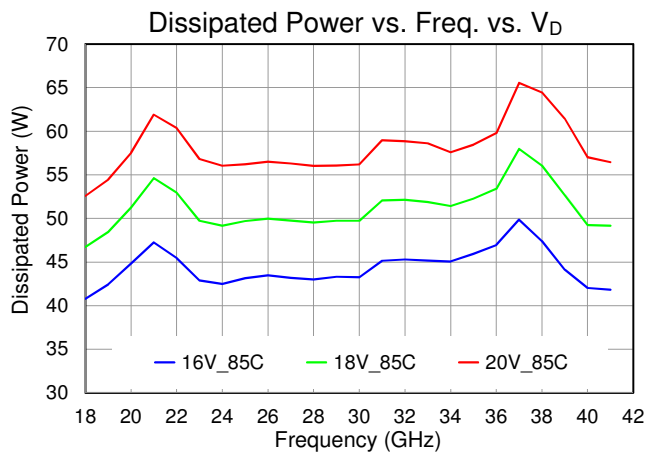

Test conditions, unless otherwise noted: CW,  $V_D = 18 V$ ,  $I_{DQ} = 2040 mA$ ,  $P_{IN} = 27 dBm$ ,  $T_{BASE} = 85^{\circ}C$  ( $T_{BASE}$  is backside of QPA2640T)

### Applications Information

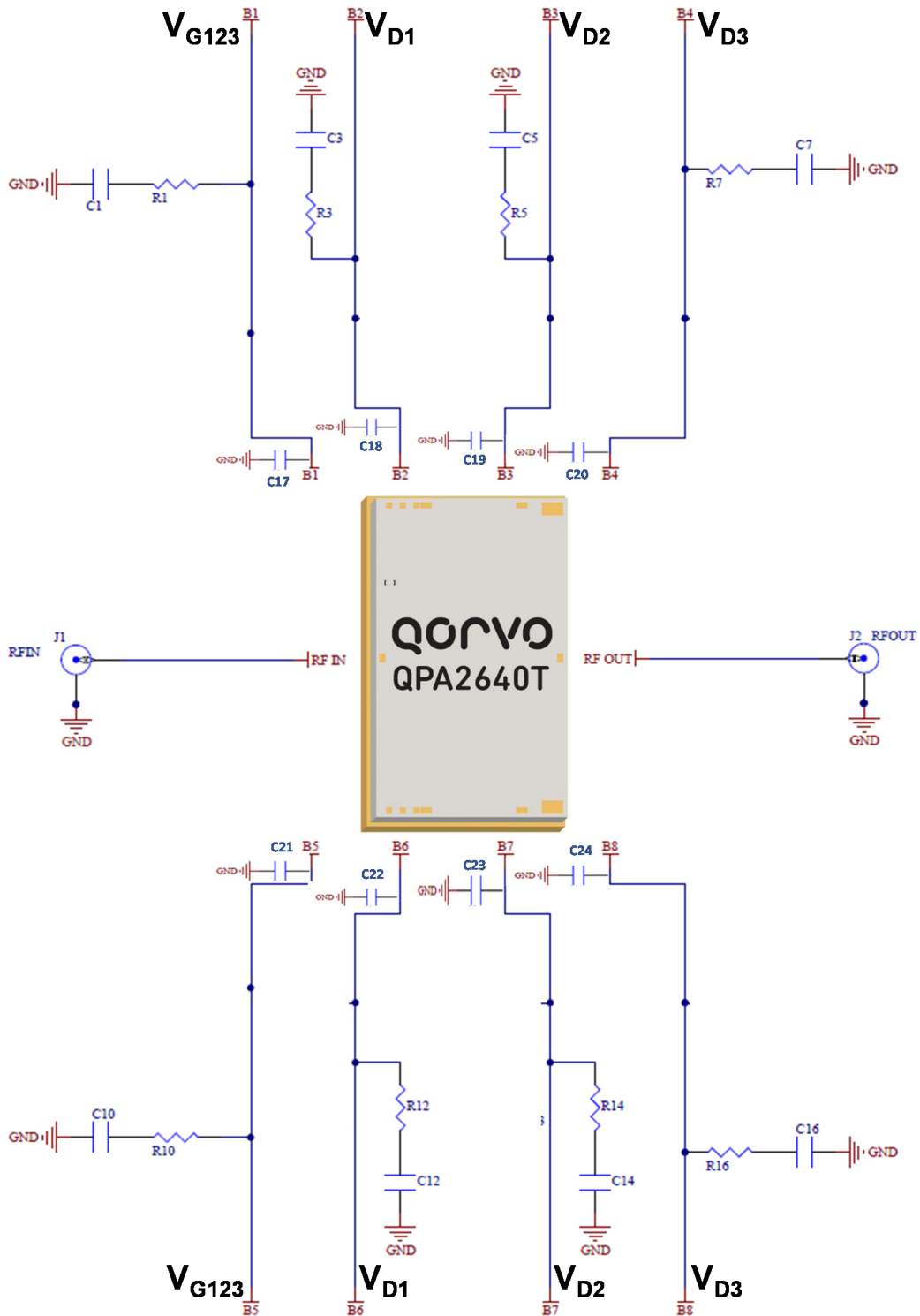

DC must be biased from both sides

Evaluation Board (EVB) Layout

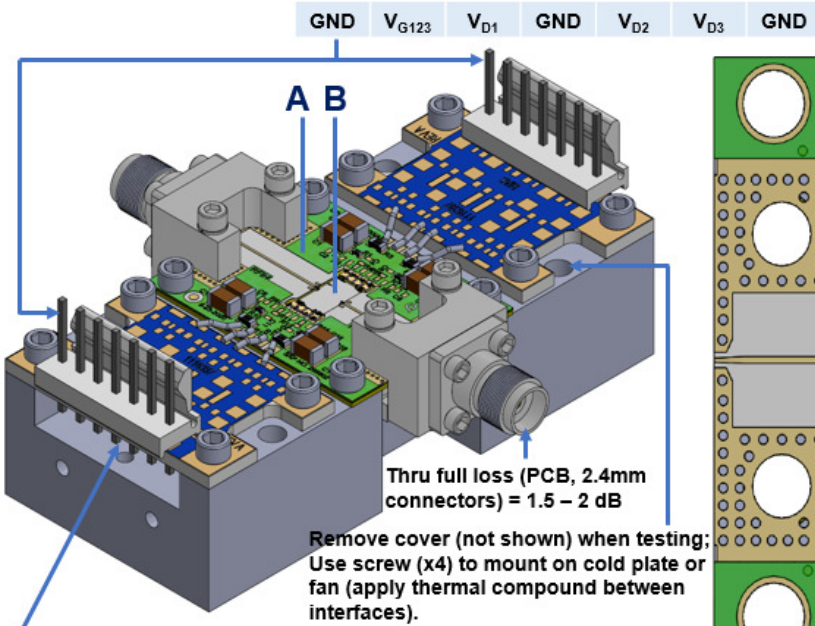

T<sub>BASE</sub> is backside of QPA2640T  
Slide in Thermocouple into H-block's hole (behind DC pins)  
T<sub>BASE</sub> ≈ Thermocouple + 32 °C

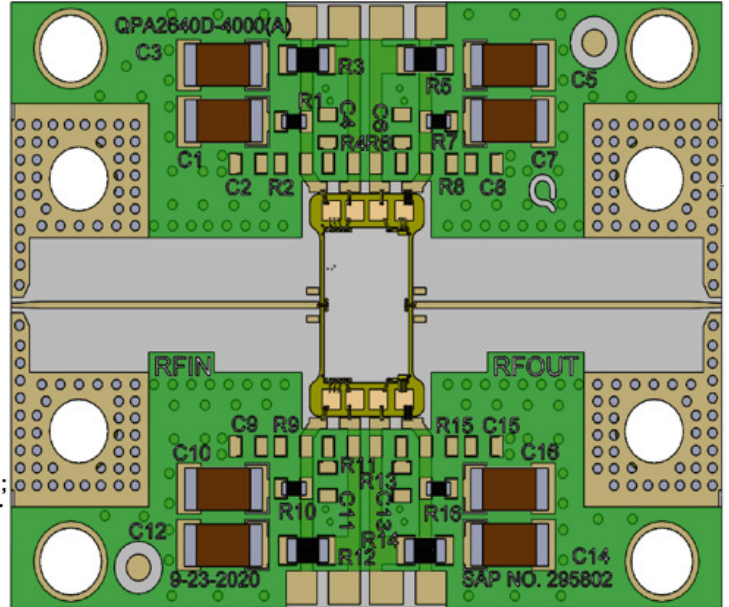

DETAIL A

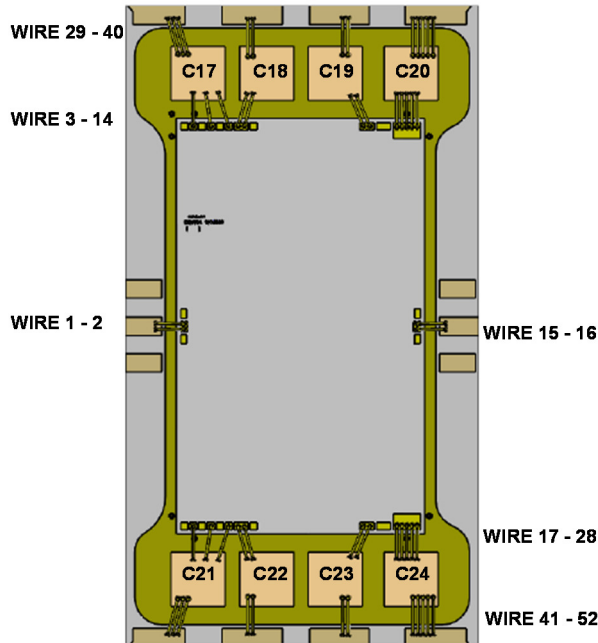

DETAIL B

EVB as shown is for the QPA2640D (bare die) which also is used for QPA2640T

## Bill of Materials

Reference Des.	Qty	Value	Description	Part Number
C1, C3, C5, C7, C10, C12, C14, C16	8	10 uF	CAP, 10uF, 20%, 50V, 20%, X5R, 1206	
C17 – C24	8	10 nF	CAP, 10nF, ±15%, 30V, SLC, 0303	
R1, R7, R10, R16	4	0 Ω	RES, 0 Ohm, JMPR, 0402	
R3, R5, R12, R14	4		RES, 0 Ohm, 1/10W, 0603	
PCB_MMIC	1		PCB for MMIC, Taconics RF-35HTC 0.005", 0.5oz Ni/Pd/Au plating both sides, total thickness 0.009"	Qorvo, Custom
PCB_Bias	2		PCB for DC Bias	Qorvo, Custom
H1, H2	2		CONN, HDR, Male-vert, 7 PIN, 1 RAW, MTA	
J1, J2	2		Connector, RF 2.4mm, F, Pin 0.005, Diel 0.029	Southwest Microwave 1492-04A-12
CP	1		Carrier Plate, CuMo, 0.9 x 1.15 x 0.02T	Qorvo, Custom
H-Block	1		H-Block, Copper C110, 1.14 x 2.49 x 0.59T	Qorvo, Custom
S1 – S4	12		Screw, Cap, Socket Head, 2-56X1/8"	
S5 – S12	8		Screw, Cap, Socket Head, 2-56X3/16"	
AuSn			AuSn Solder preform	
Epoxy			Epoxy preform	
Ablebond			Epoxy, Ablebond 84-1LMI	
Solder			Paste, solder, Syntech, Sn63/Pb37	
TC			Thermal Compound, Silver 5GR	Artic Silver 5 AS5-5G

Bill of Materials based on the EVB for the QPA2640D (bare die)

### Bias-Up Procedure

1. Set  $I_D$  limit to 5 A,  $I_G$  limit to 50 mA
2. Set  $V_G$  to  $-3.8$  V
3. Set  $V_D$  18 V. Ensure  $I_{DQ} \sim 0$  mA
4. Adjust  $V_G$  more positive until  $I_D = 2040$  mA;  
 $V_G \approx -2.3$  V +/- 0.6V typical range
5. Apply RF signal

### Bias-Down Procedure

1. Turn off RF signal
2. Reduce  $V_G$  to  $-3.8$  V. Ensure  $I_{DQ} \sim 0$  mA
3. Set  $V_D$  to 0 V
4. Turn off  $V_D$  supply
5. Turn off  $V_G$  supply

Mechanical Information (MMIC Only)

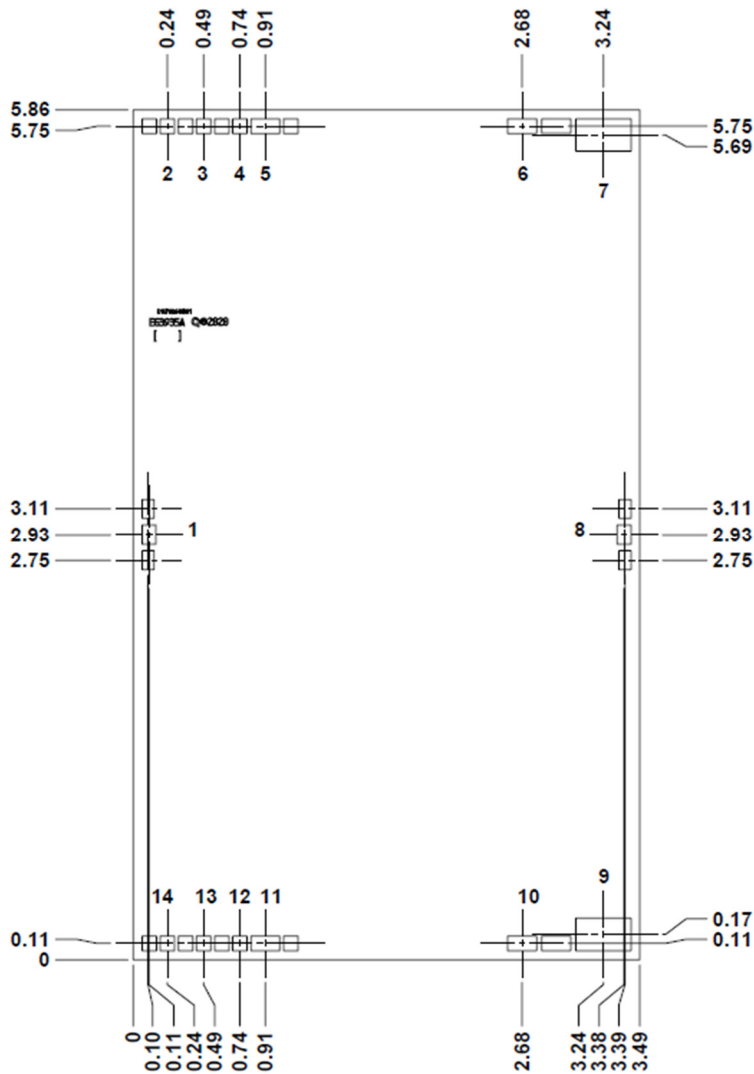

Dimensions: mm; Thickness: 0.05 mm; Die x, y size tolerance: ± 0.050; Ground is backside of die

Bond Pad Description

Pad No.	Symbol	Pad Size (mm)	Description
1	RF <sub>IN</sub>	0.10 x 0.14	RF Input. Matched to 50 Ω, DC blocked
2, 14	V <sub>G1</sub>	0.10 x 0.10	Gate voltage for stage 1*
3, 13	V <sub>G2</sub>	0.10 x 0.10	Gate voltage for stage 2*
4, 12	V <sub>G3</sub>	0.10 x 0.10	Gate voltage for stage 3*
5, 11	V <sub>D1</sub>	0.20 x 0.10	Drain voltage for stage 1*
6, 10	V <sub>D2</sub>	0.20 x 0.22	Drain voltage for stage 2*
7, 9	V <sub>D3</sub>	0.30 x 0.10	Drain voltage for stage 3*
8	RF <sub>OUT</sub>	0.10 x 0.14	RF Output. Matched to 50 Ω, DC blocked

\* External bypassing required; refer to page 18 for recommendation

Mechanical Information (MMIC on Tab)

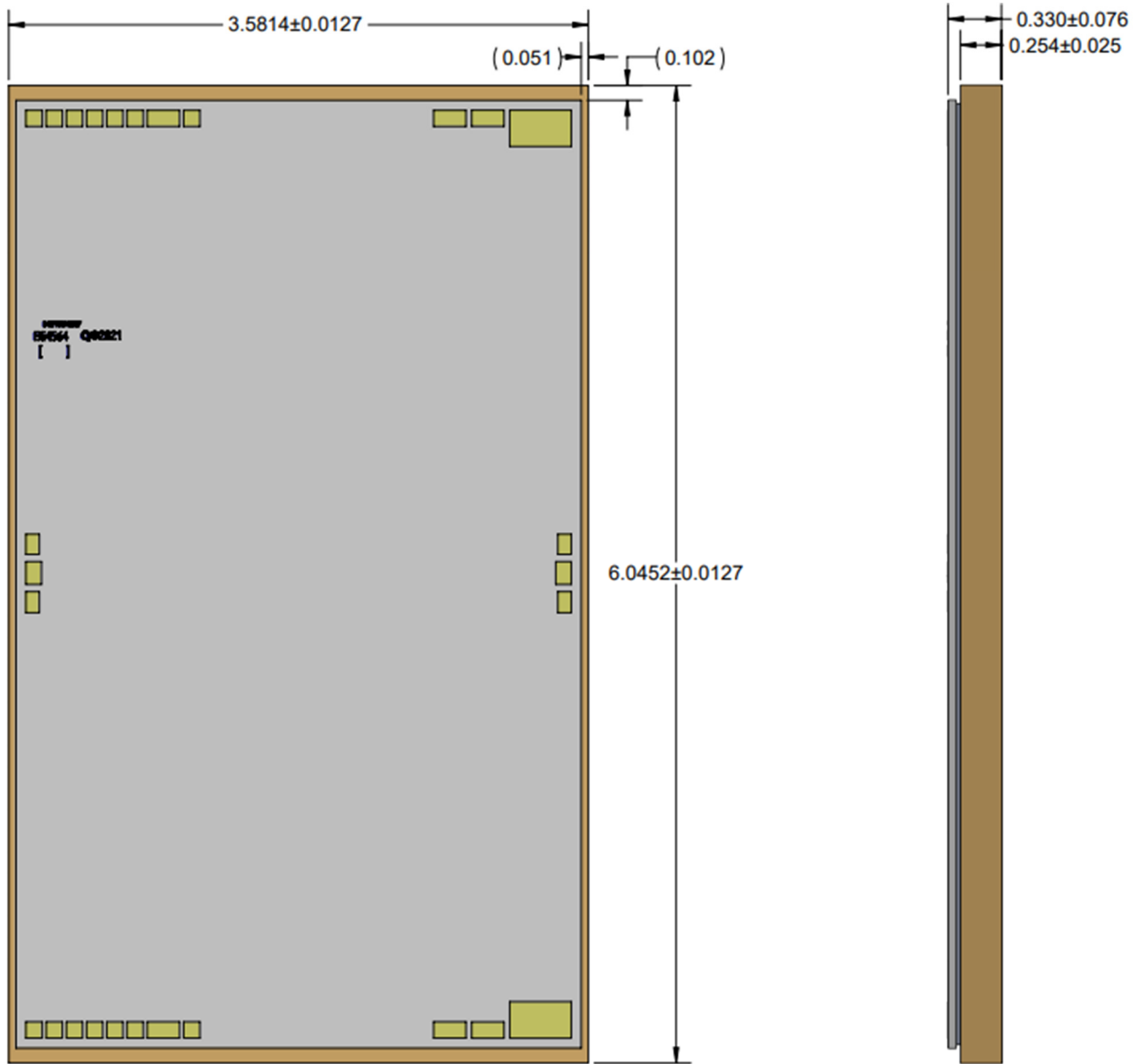

Dimensions: mm  
 Tab material: CuMo  
 Tab plating: Au

## Assembly Notes

---

Component placement and adhesive attachment assembly notes:

- Vacuum pencils and/or vacuum collets are the preferred method of pick up.
- Air bridges must be avoided during placement.
- The force impact is critical during auto placement.

Interconnect process assembly notes:

- Thermosonic ball bonding is the preferred interconnect technique.
- Force, time, and ultrasonic are critical parameters.
- Aluminum wire should not be used.
- Devices with small pad sizes should be bonded with 0.0007-inch wire.
- Maximum stage temperature is 200 °C.

## Handling Precautions

Parameter	Rating	Standard
ESD – Human Body Model (HBM)	1A	ANSI/ESD/JEDEC JS-001



Caution!  
 ESD-Sensitive Device

## RoHS Compliance

This part is compliant with 2011/65/EU RoHS directive (Restrictions on the Use of Certain Hazardous Substances in Electrical and Electronic Equipment) as amended by Directive 2015/863/EU.

This product also has the following attributes:

- Lead Free
- Halogen Free (Chlorine, Bromine)
- Antimony Free
- TBBP-A (C<sub>15</sub>H<sub>12</sub>Br<sub>4</sub>O<sub>2</sub>) Free
- PFOS Free
- SVHC Free

## Contact Information

For the latest specifications, additional product information, worldwide sales and distribution locations:

**Web:** [www.qorvo.com](http://www.qorvo.com)

**Tel:** 1-844-890-8163

**Email:** [customer.support@qorvo.com](mailto:customer.support@qorvo.com)

## Important Notice

The information contained herein is believed to be reliable; however, Qorvo makes no warranties regarding the information contained herein and assumes no responsibility or liability whatsoever for the use of the information contained herein. All information contained herein is subject to change without notice. Customers should obtain and verify the latest relevant information before placing orders for Qorvo products. The information contained herein or any use of such information does not grant, explicitly or implicitly, to any party any patent rights, licenses, or any other intellectual property rights, whether with regard to such information itself or anything described by such information. **THIS INFORMATION DOES NOT CONSTITUTE A WARRANTY WITH RESPECT TO THE PRODUCTS DESCRIBED HEREIN, AND QORVO HEREBY DISCLAIMS ANY AND ALL WARRANTIES WITH RESPECT TO SUCH PRODUCTS WHETHER EXPRESS OR IMPLIED BY LAW, COURSE OF DEALING, COURSE OF PERFORMANCE, USAGE OF TRADE OR OTHERWISE, INCLUDING THE IMPLIED WARRANTIES OF MERCHANTABILITY AND FITNESS FOR A PARTICULAR PURPOSE.**

Without limiting the generality of the foregoing, Qorvo products are not warranted or authorized for use as critical components in medical, life-saving, or life-sustaining applications, or other applications where a failure would reasonably be expected to cause severe personal injury or death.

Copyright 2022 © Qorvo, Inc. | Qorvo is a registered trademark of Qorvo, Inc.

## Looking for pricing, stock, or lifecycle information?

Click below to explore more details on WIN SOURCE:

 [View QPA2640T on WIN SOURCE](#)

 [Qorvo US Inc. Information](#)

## Optimize Your Supply Chain with WIN SOURCE Solutions

-  Global Sourcing Solution
-  Obsolete Management
-  Cost Control Management
-  Shortage Management
-  Alternative Solution
-  Excess Inventory Management