

Product Overview

Qorvo's QPA2212T is a Ka-band power amplifier fabricated on Qorvo's 0.15um GaN on SiC process (QGaN15), mounted to a high thermal conductivity tab. Operating between 27.5 and 31 GHz, it achieves 10 W linear power with -25 dBc intermodulation distortion products and 22 dB small signal gain. Saturated output power is 25 W with power-added efficiency of 25%.

QPA2212T is ideally suited to support satellite communications and 5G infrastructure.

To simplify system integration, the QPA2212T is fully matched to 50 ohms with integrated DC blocking caps on both I/O ports.

The QPA2212T is 100% DC and RF tested on-wafer to ensure compliance to electrical specifications.

Lead-free and RoHS compliant.



Key Features

- Frequency Range: 27.5–31 GHz
- P_{SAT} ($P_{IN}=25$ dBm): 43.4 dBm
- PAE ($P_{IN}=25$ dBm): 25 %
- Power Gain ($P_{IN}=25$ dBm): 18.4 dB
- IMD3 (at 37 dBm/tone): -25 dBc
- Small Signal Gain: 22 dB
- Bias: $V_D = 22$ V, $I_{DQ} = 460$ mA
- Tab Dimensions: 3.759 mm x 5.258 mm x 0.254 mm

Performance is typical across frequency. Please reference electrical specification table and data plots for more details.

Functional Block Diagram

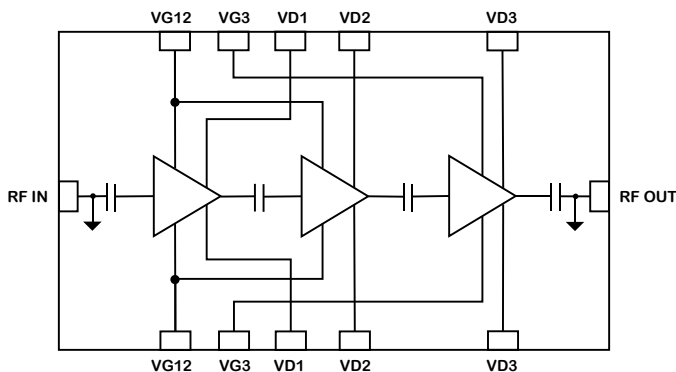

Applications

- 5G Infrastructure
- Satellite Communications

Ordering Information

Part No.	Description
QPA2212T	27.5–31 GHz 25 Watt GaN Amplifier (100 Pcs.)

Absolute Maximum Ratings

Parameter	Value / Range
Drain Voltage (V_D)	29.5 V
Gate Voltage Range (V_G)	-5 V to 0 V
Drain Current (I_D)	5860 mA
Gate Current (I_G)	See plot pg. 17
Power Dissipation (P_{DISS}), 85 °C	80.3 W
Input Power (P_{IN}), 50 Ω , $V_D=22$ V, $I_{DQ}=460$ mA, 85 °C	34 dBm
Input Power (P_{IN}), 3:1 VSWR, $V_D=22$ V, $I_{DQ}=460$ mA, 85 °C	34 dBm
Storage Temperature	-55 to +150 °C

Operation of this device outside the parameter ranges given above may cause permanent damage. These are stress ratings only, and functional operation of the device at these conditions is not implied.

Electrical Specifications

Parameter		Min	Typ	Max	Units
Operational Frequency		27.5		31	GHz
Output Power ($P_{IN}=25$ dBm)	27.5 GHz 29 GHz 31 GHz		44.0 44.2 43.9		dBm dBm dBm
Power Added Efficiency ($P_{IN}=25$ dBm)	27.5 GHz 29 GHz 31 GHz		27.2 26.9 25.3		% % %
Small Signal Gain	27.5 GHz 29 GHz 31 GHz		23.0 22.4 21.7		dB dB dB
Input Return Loss	27.5 GHz 29 GHz 31 GHz		9 17 29		dB dB dB
Output Return Loss	27.5 GHz 29 GHz 31 GHz		9 14 9		dB dB dB
IMD3 ($P_{OUT}/\text{Tone} = 37$ dBm, 10 MHz tone spacing)	27.5 GHz 29 GHz 31 GHz		-38 -38 -29		dBc dBc dBc
P_{OUT} Temp. Coeff. (85 °C to 25 °C, $P_{IN} = 25$ dBm))			-0.033		dB/°C
Sm. Sig. Gain Temp. Coefficient (85 °C to -40 °C)			-0.119		dB/°C

1. Test conditions, unless otherwise noted: $T = +25$ °C, $V_D = 22$ V, $I_{DQ} = 460$ mA
2. All performance data presented is for the QPA2212D (bare die)

¹ Typical P_{SAT} measured on die evaluation board. Manufacturing Test RF probe minimum P_{SAT} specification is 42.5 dBm at 27.5 and 31 GHz, 43 dBm at 28, 29, and 30 GHz.

Recommended Operating Conditions

Parameter	Value / Range
Drain Voltage (V_D)	22 V
Drain Current (I_{DQ})	460 mA
Operating Temperature	-40 to +85 °C

Electrical specifications are measured at specified test conditions. Specifications are not guaranteed over all recommended operating conditions.

Performance Plots – Large Signal

Test conditions, unless otherwise noted: $V_D = 22\text{ V}$, $I_{DQ} = 460\text{ mA}$, $T = +25\text{ }^\circ\text{C}$, $P_{IN} = 25\text{ dBm}$
All performance data presented is for the QPA2212D (bare die)

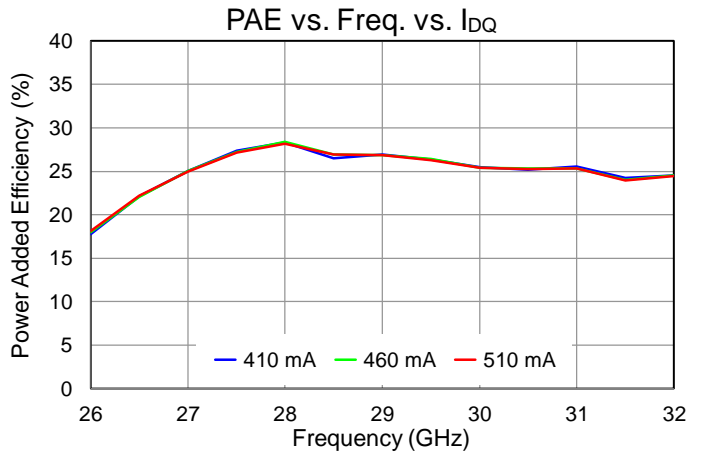
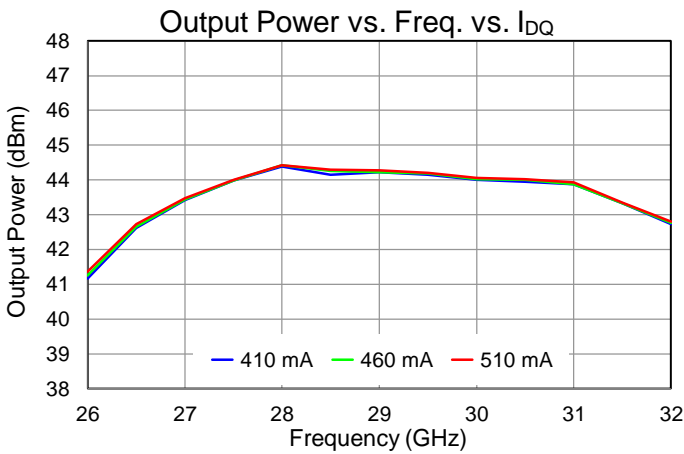
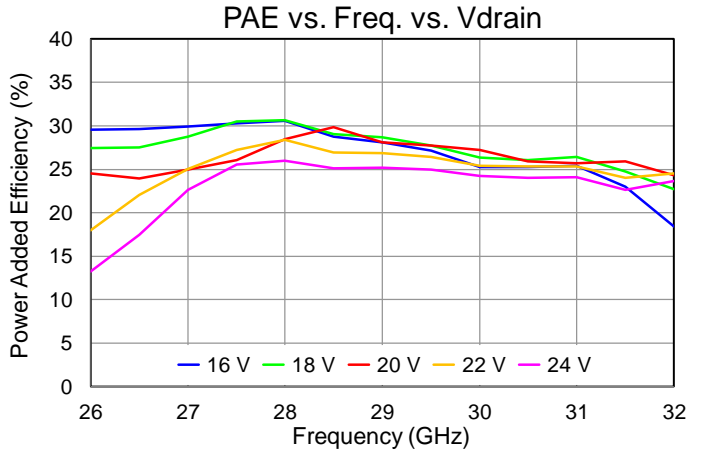
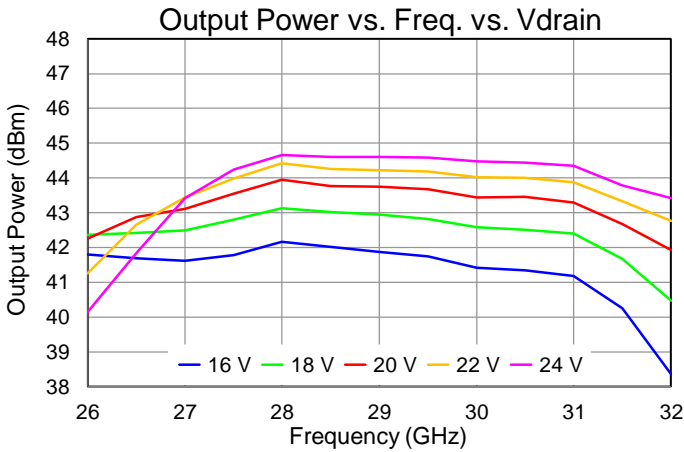
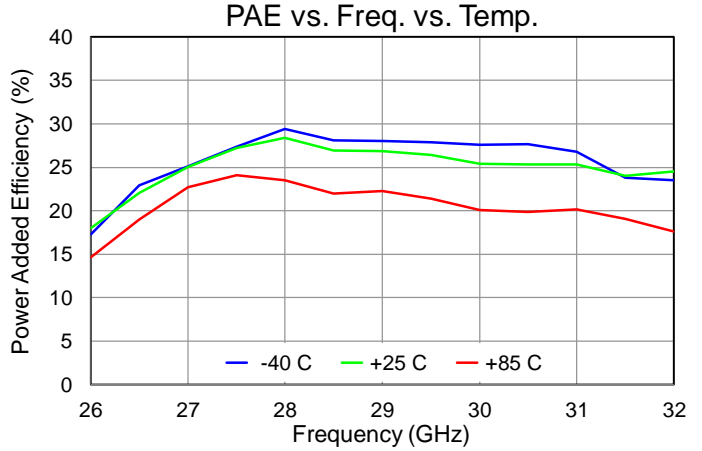
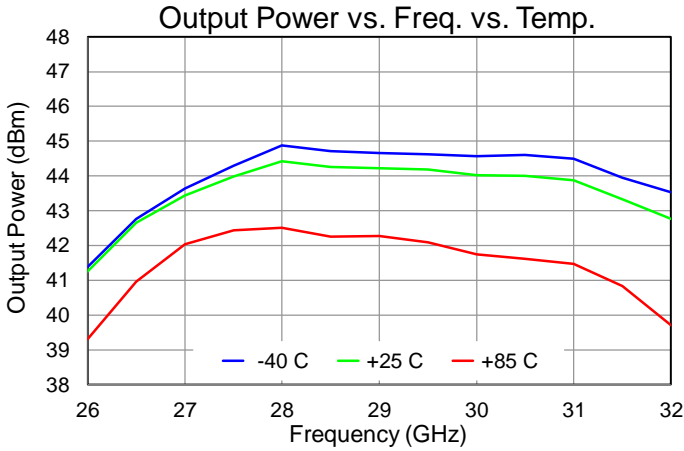

Performance Plots – Large Signal

Test conditions, unless otherwise noted: $V_D = 22\text{ V}$, $I_{DQ} = 460\text{ mA}$, $T = +25\text{ }^\circ\text{C}$, $P_{IN} = 25\text{ dBm}$
All performance data presented is for the QPA2212D (bare die)

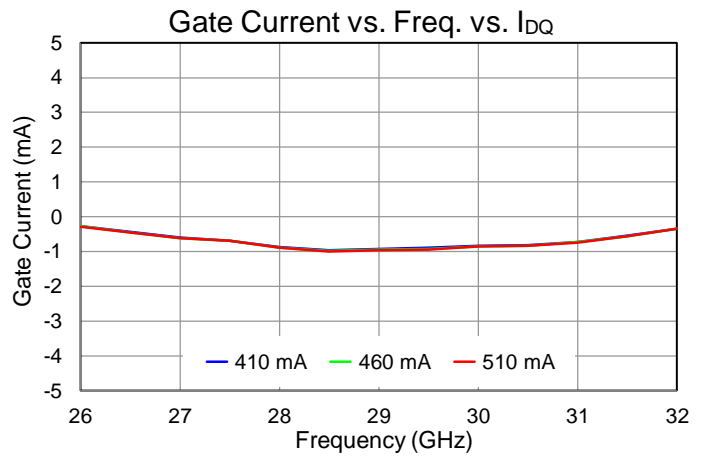
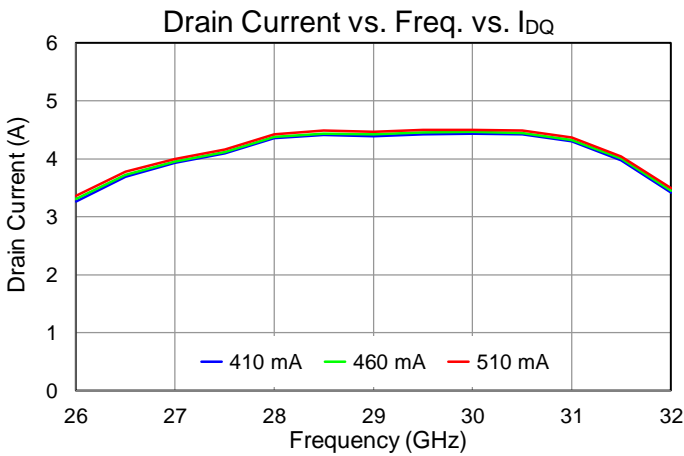
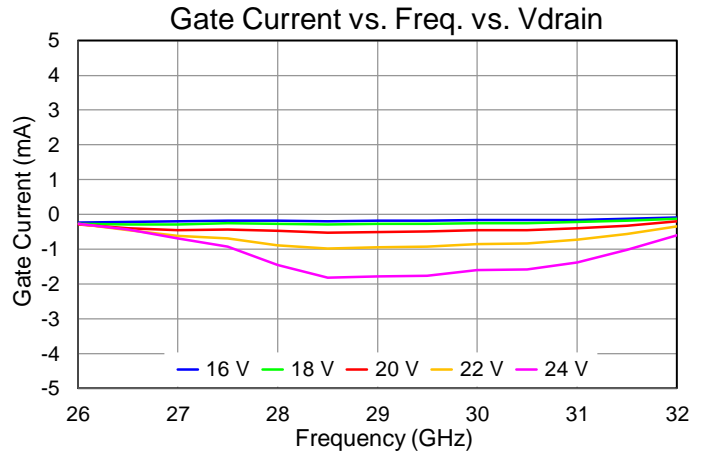
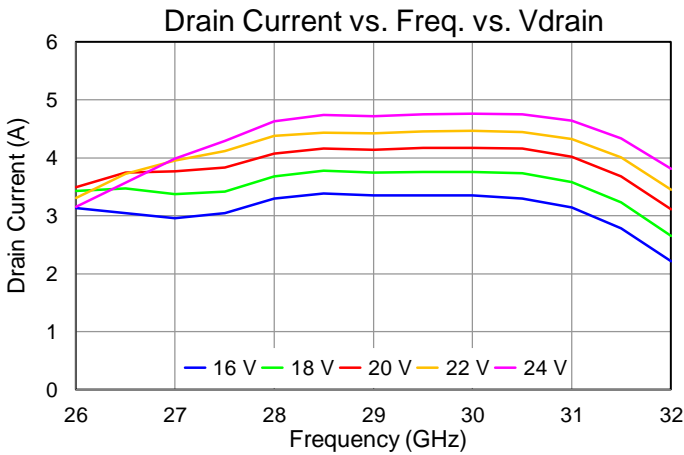
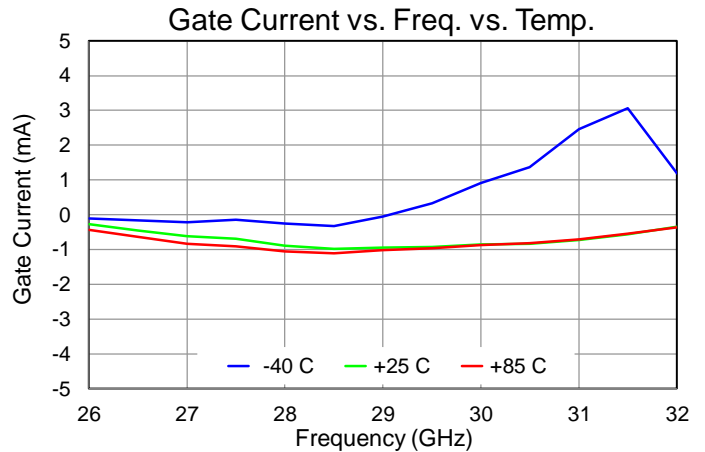
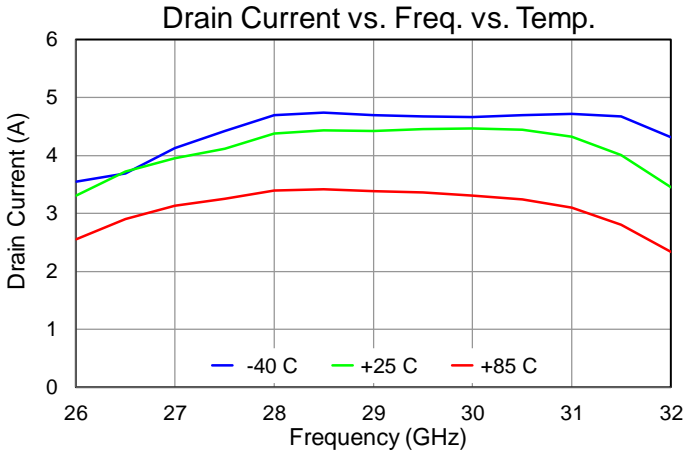

Performance Plots – Large Signal

Test conditions, unless otherwise noted: $V_D = 22\text{ V}$, $I_{DQ} = 460\text{ mA}$, $T = +25\text{ }^\circ\text{C}$
All performance data presented is for the QPA2212D (bare die)

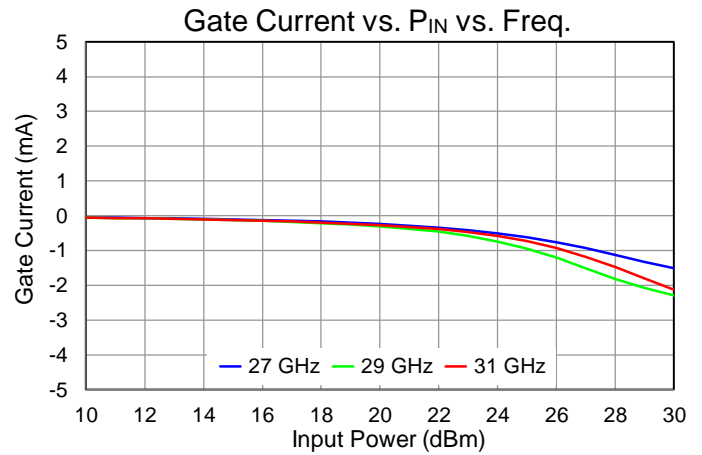
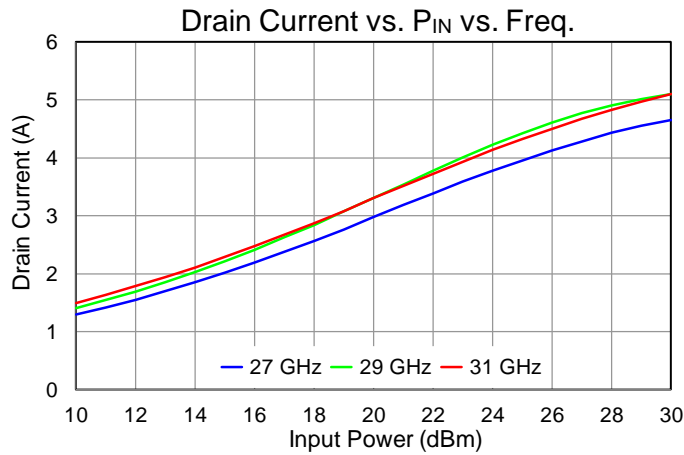
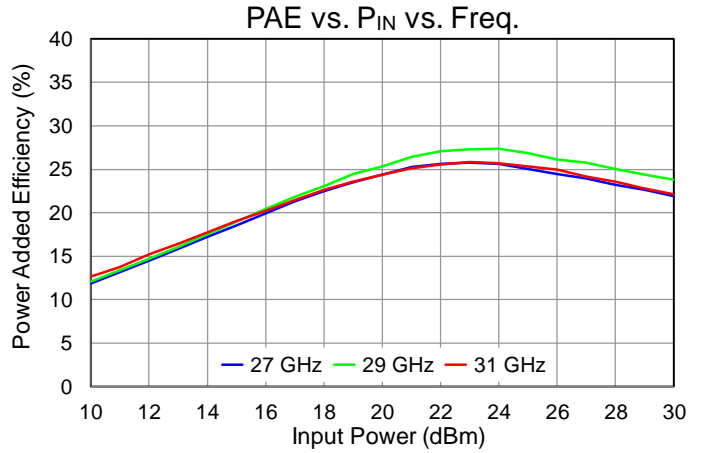
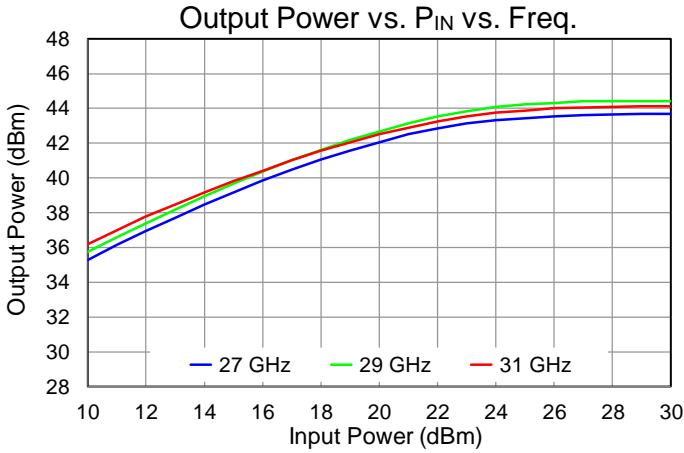

Performance Plots – Large Signal

Test conditions, unless otherwise noted: $V_D = 22\text{ V}$, $I_{DQ} = 460\text{ mA}$, $T = +25\text{ }^\circ\text{C}$
All performance data presented is for the QPA2212D (bare die)

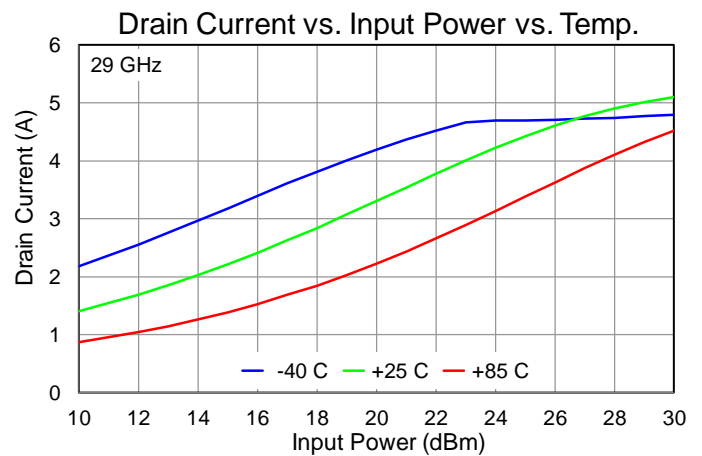
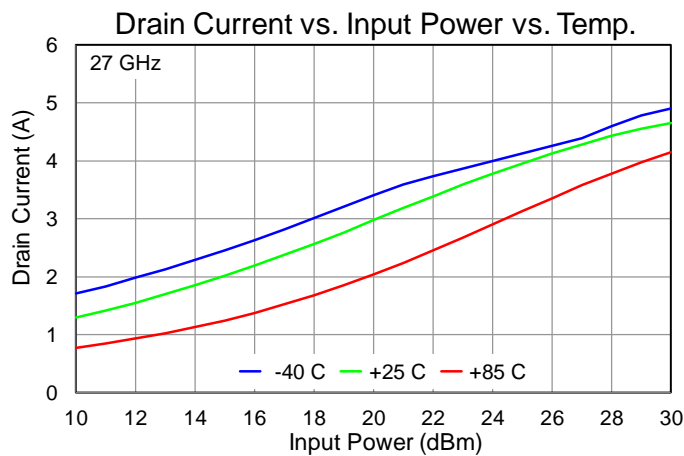
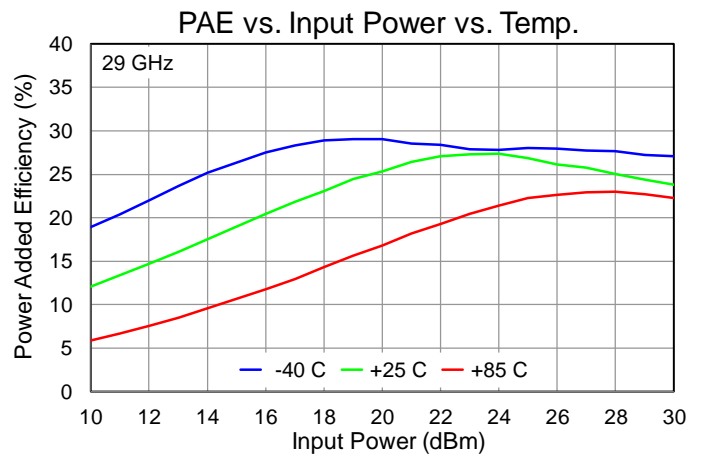
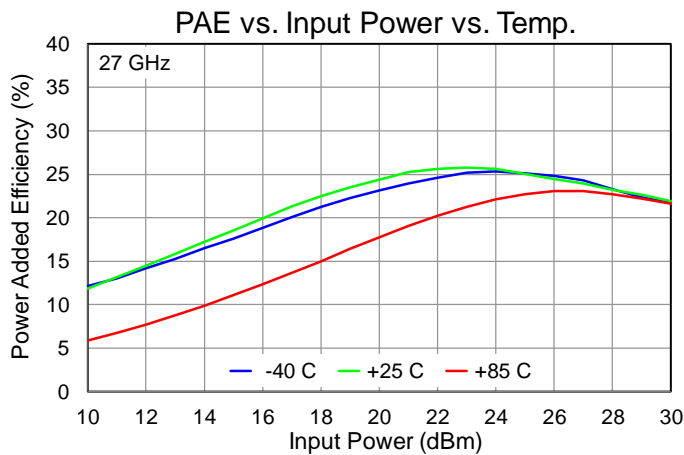
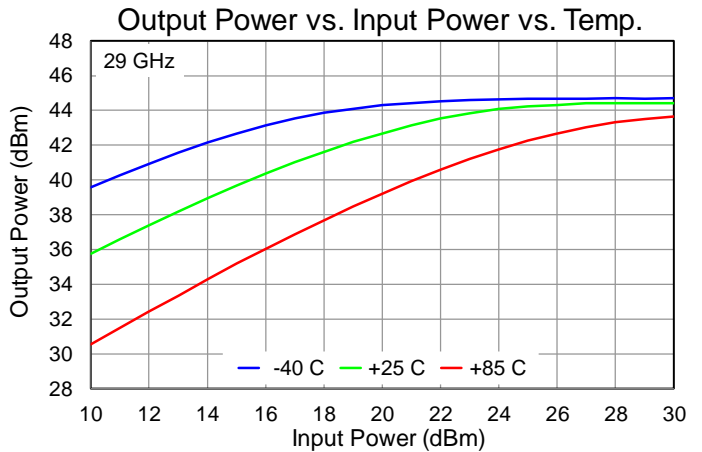
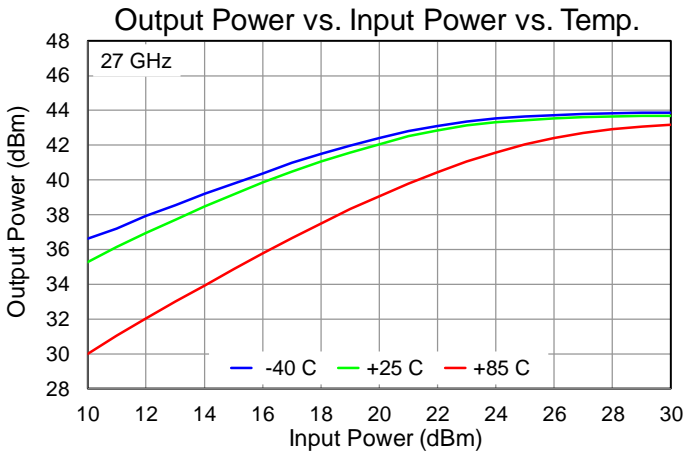

Performance Plots – Large Signal

Test conditions, unless otherwise noted: $V_D = 22\text{ V}$, $I_{DQ} = 460\text{ mA}$, $T = +25\text{ }^\circ\text{C}$
All performance data presented is for the QPA2212D (bare die)

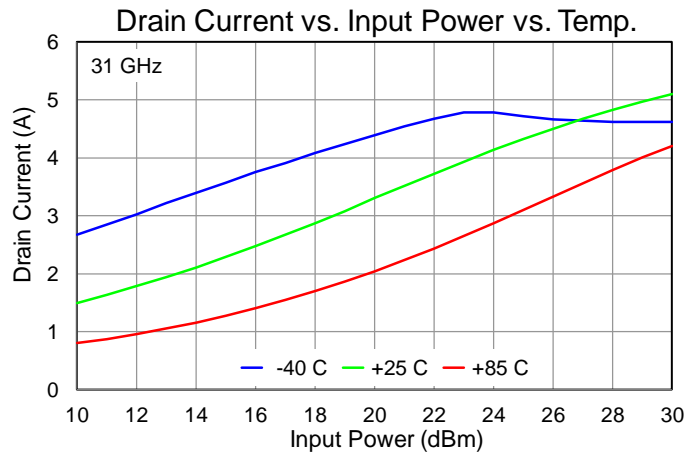
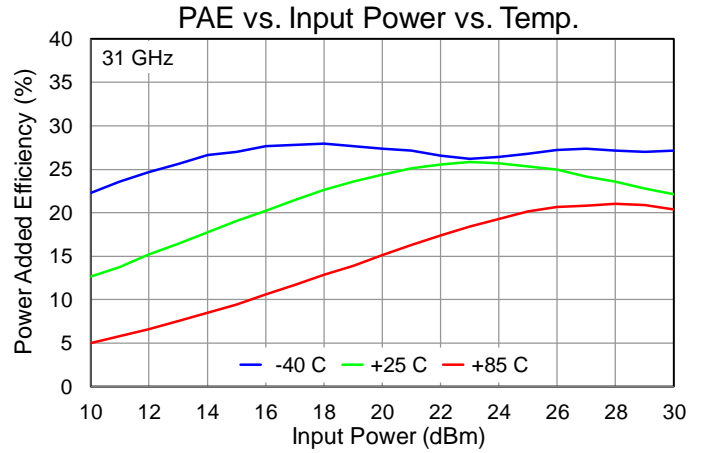
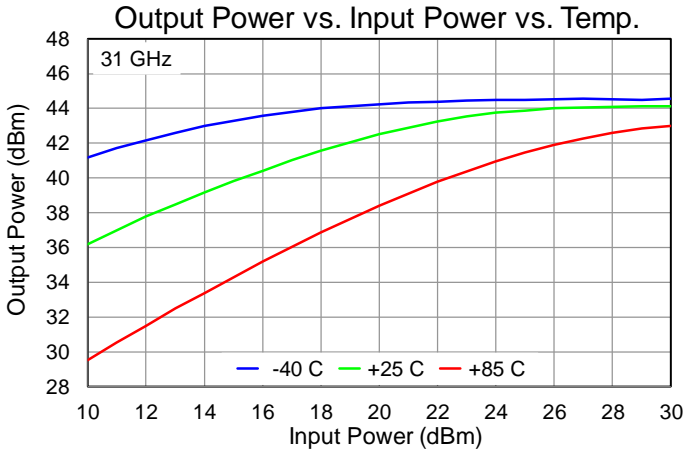

Performance Plots – Large Signal

Test conditions, unless otherwise noted: $V_D = 22\text{ V}$, $I_{DQ} = 460\text{ mA}$, $T = +25\text{ }^\circ\text{C}$
All performance data presented is for the QPA2212D (bare die)

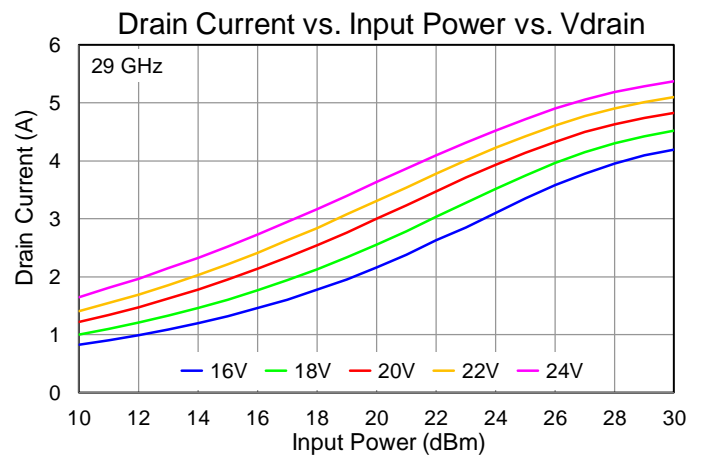
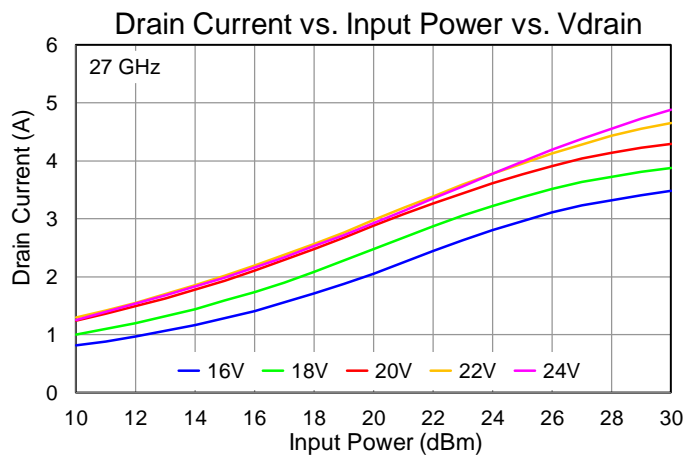
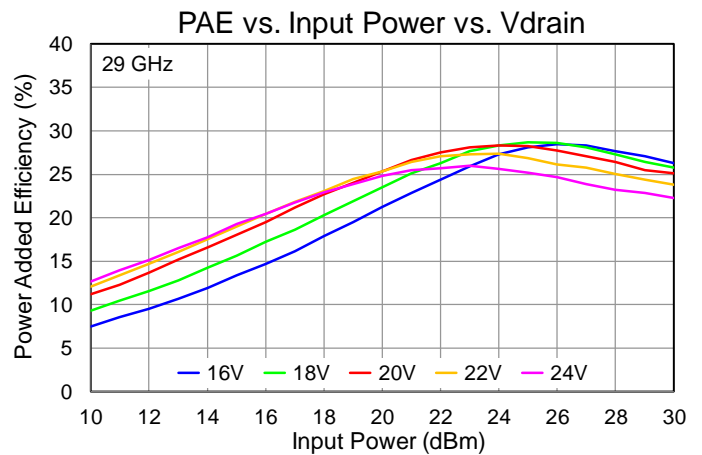
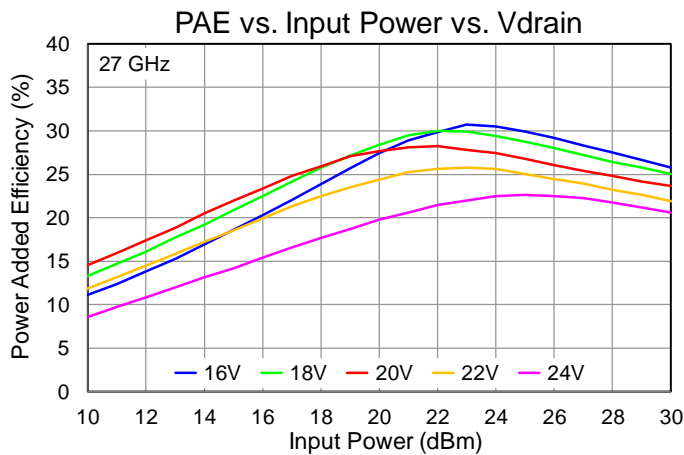
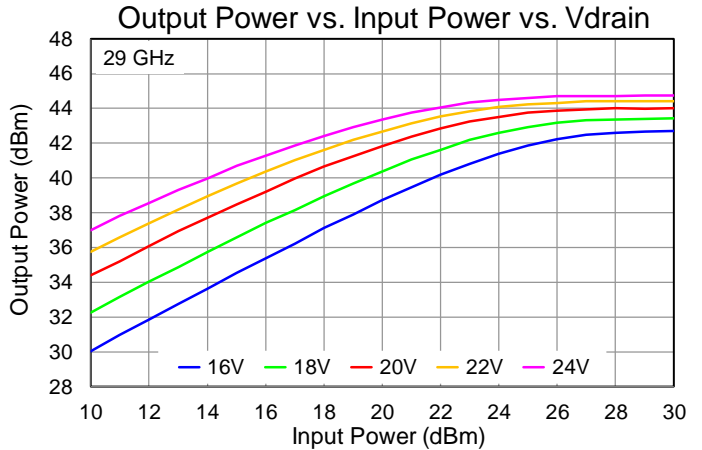
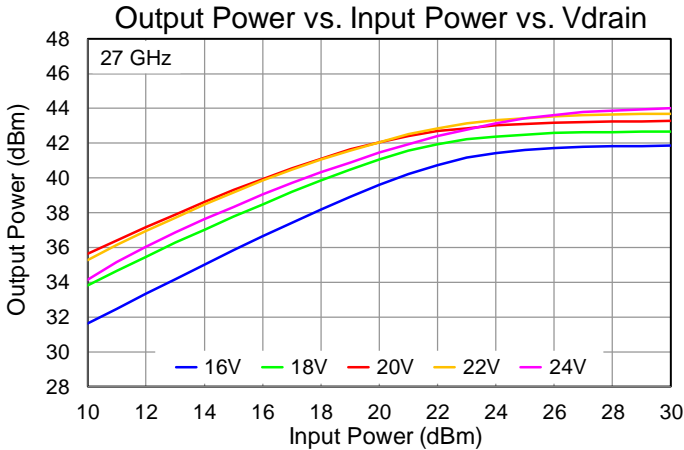

Performance Plots – Large Signal

Test conditions, unless otherwise noted: $V_D = 22\text{ V}$, $I_{DQ} = 460\text{ mA}$, $T = +25\text{ }^\circ\text{C}$
 All performance data presented is for the QPA2212D (bare die)

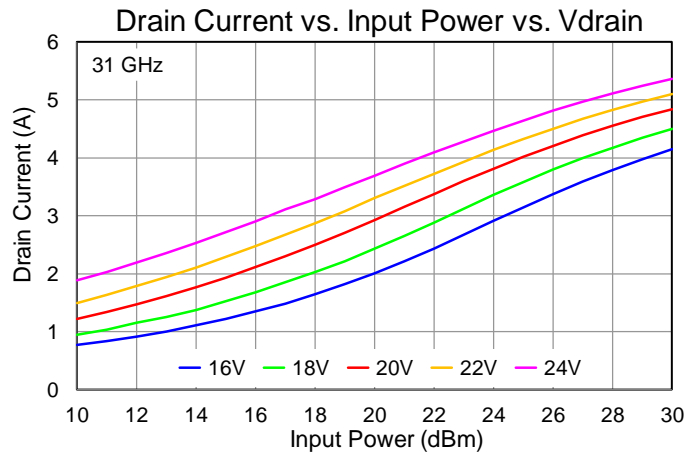
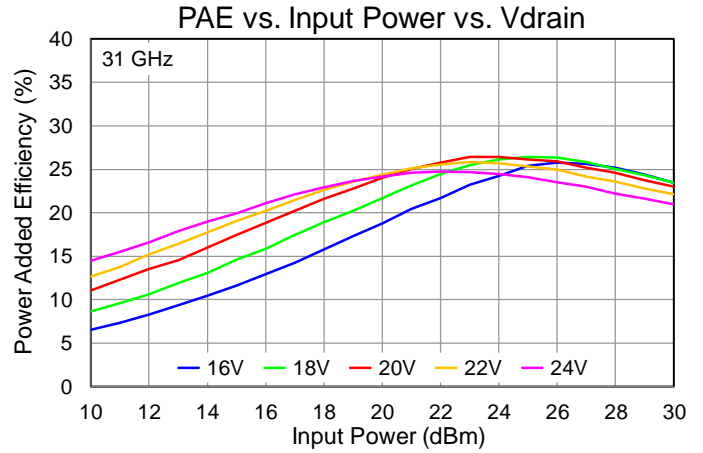
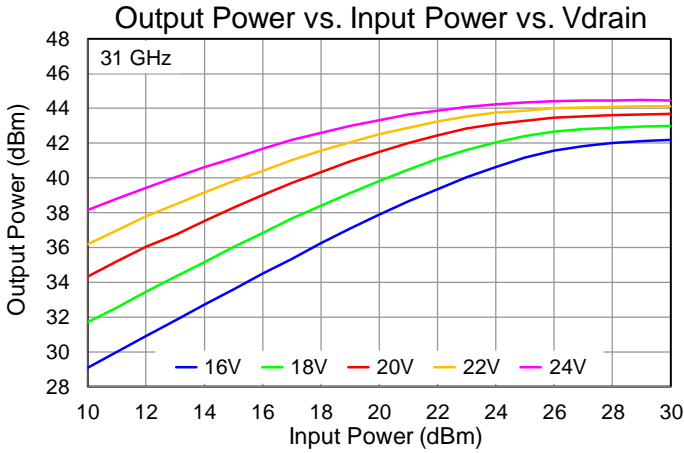

Performance Plots – Large Signal

Test conditions, unless otherwise noted: $V_D = 22\text{ V}$, $I_{DQ} = 460\text{ mA}$, $T = +25\text{ }^\circ\text{C}$
All performance data presented is for the QPA2212D (bare die)

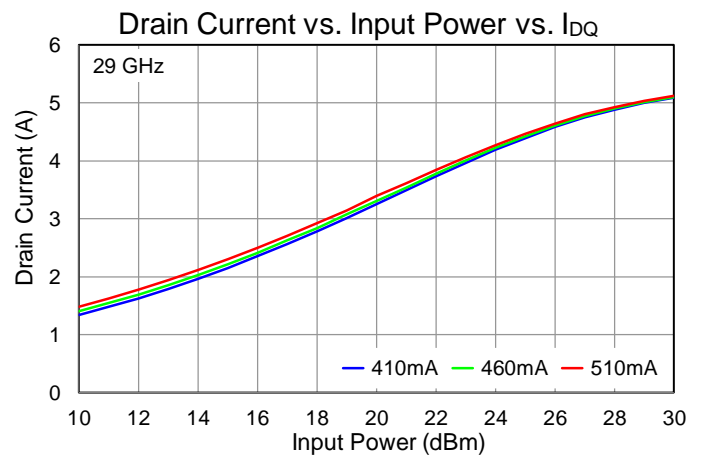
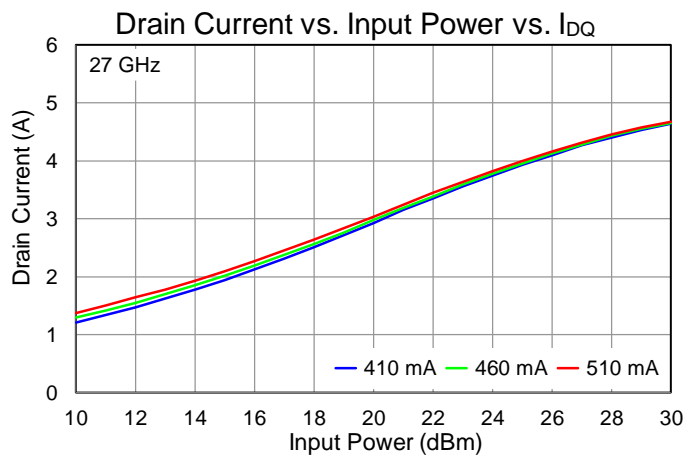
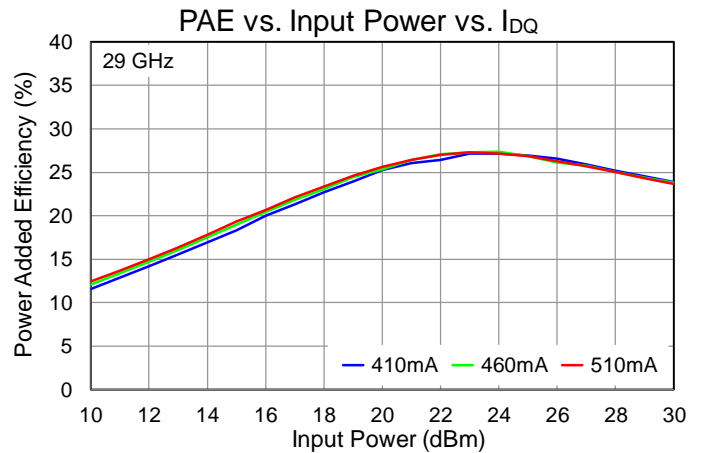
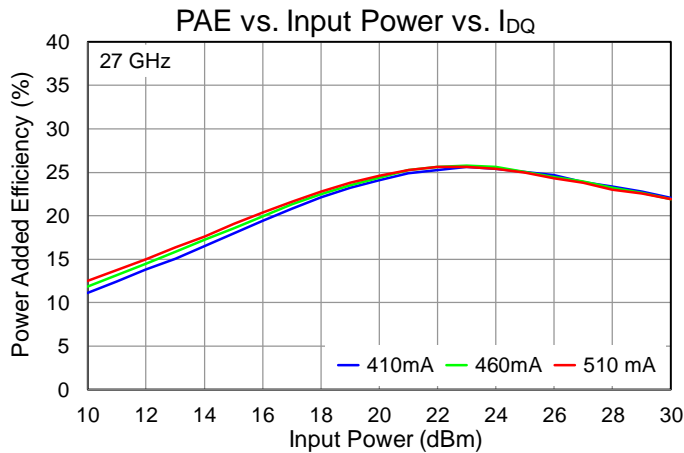
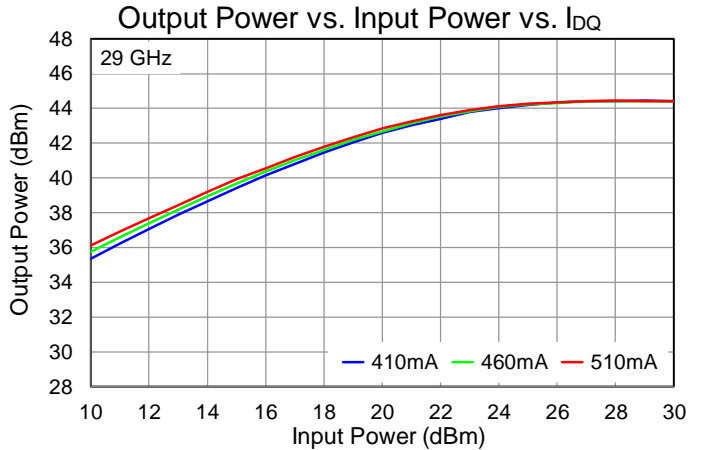
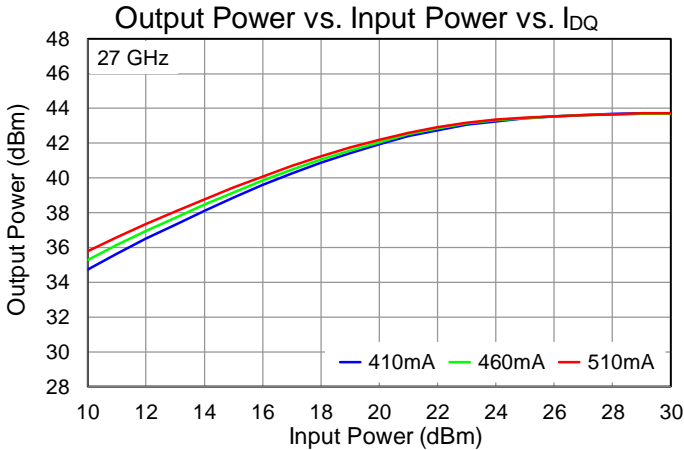

Performance Plots – Large Signal

Test conditions, unless otherwise noted: $V_D = 22\text{ V}$, $I_{DQ} = 460\text{ mA}$, $T = +25\text{ }^\circ\text{C}$

All performance data presented is for the QPA2212D (bare die)

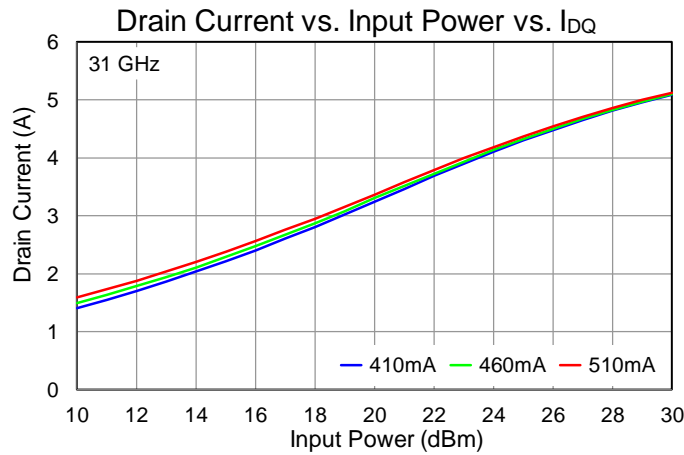
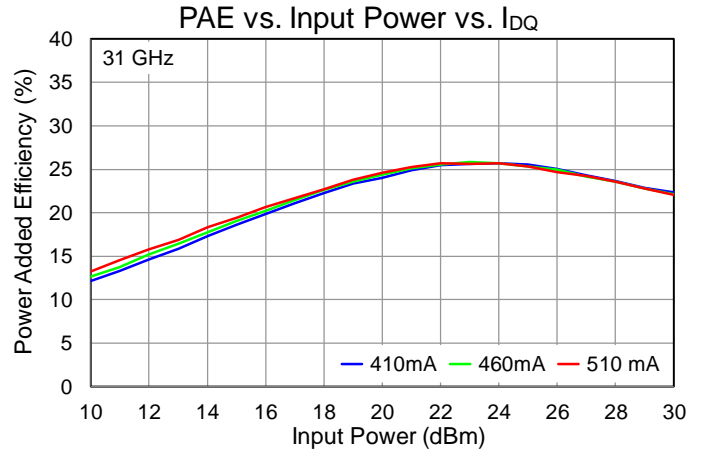
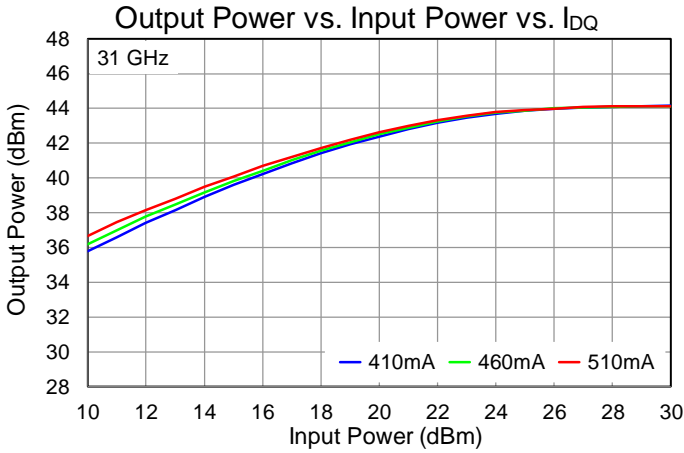

Performance Plots – Linearity

Test conditions, unless otherwise noted: $V_D = 22\text{ V}$, $I_{DQ} = 460\text{ mA}$, $T = +25\text{ }^\circ\text{C}$, 10 MHz tone spacing
All performance data presented is for the QPA2212D (bare die)

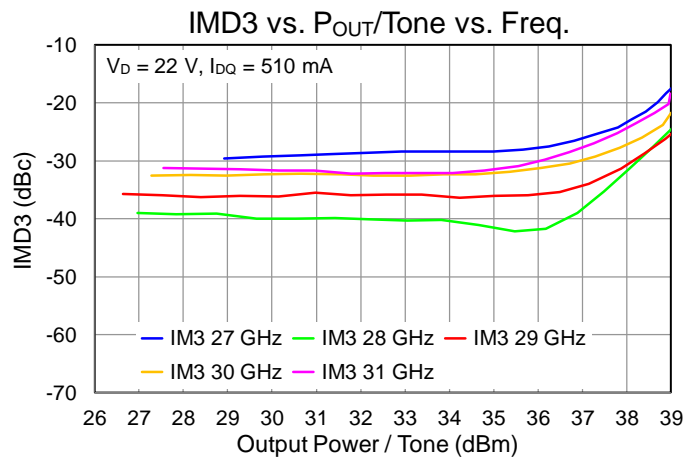
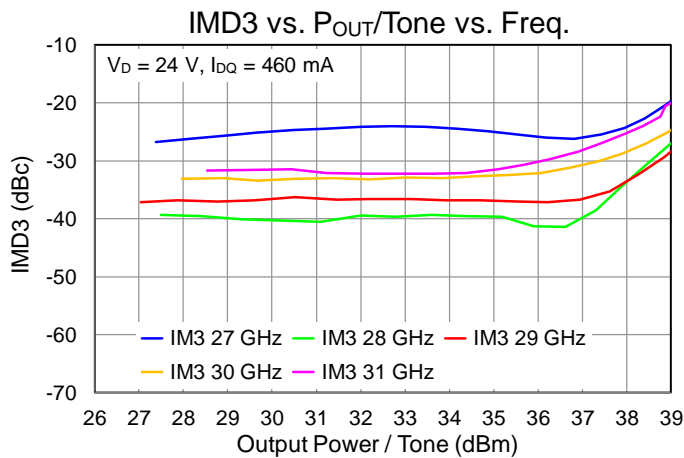
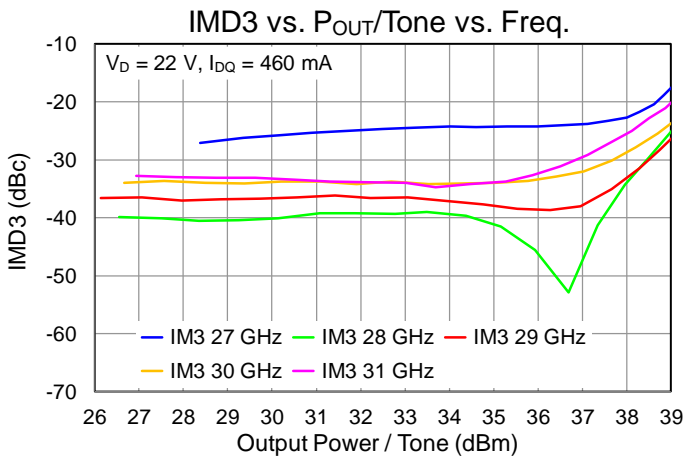
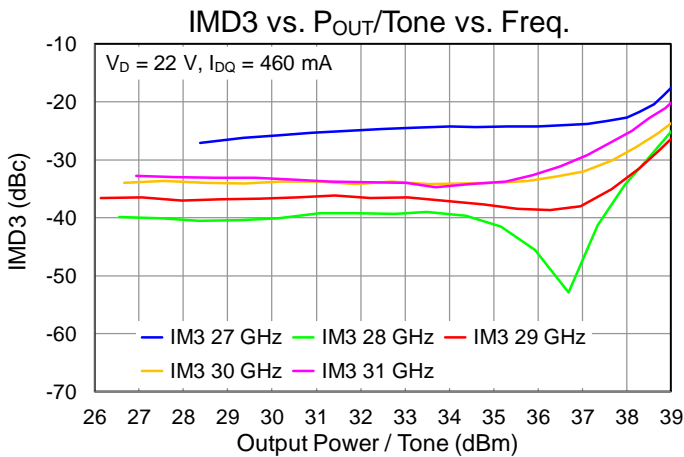
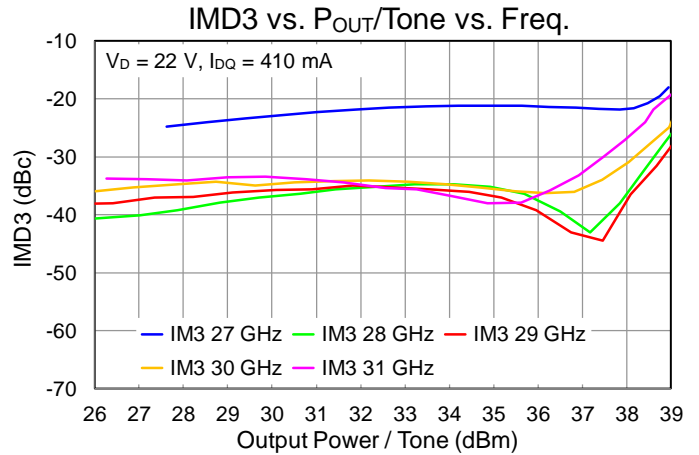
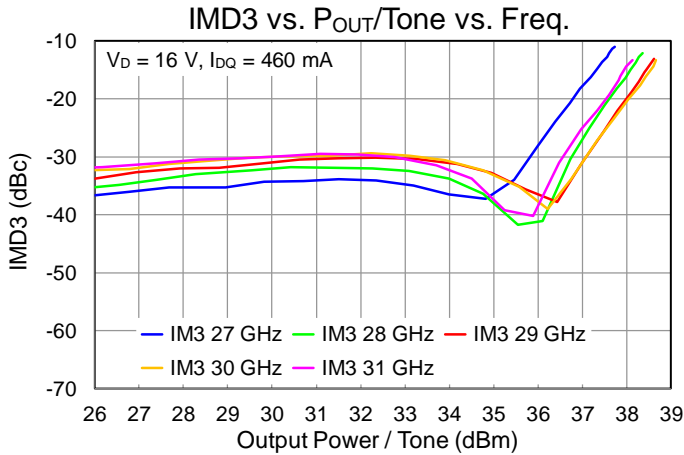

Performance Plots – Linearity

Test conditions, unless otherwise noted: $V_D = 22\text{ V}$, $I_{DQ} = 460\text{ mA}$, $T = +25\text{ }^\circ\text{C}$, 10 MHz tone spacing
All performance data presented is for the QPA2212D (bare die)

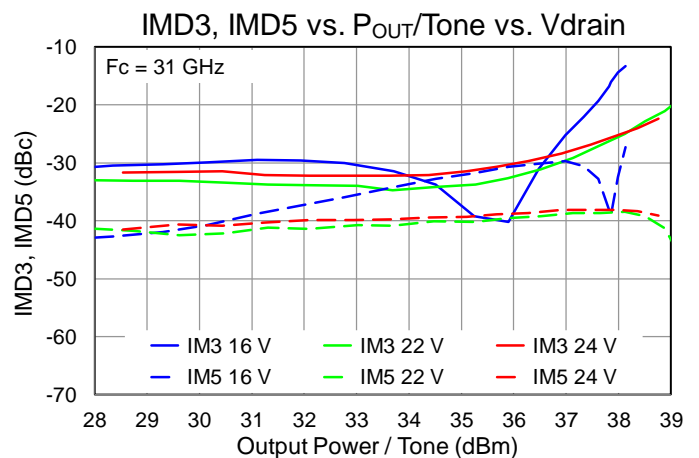
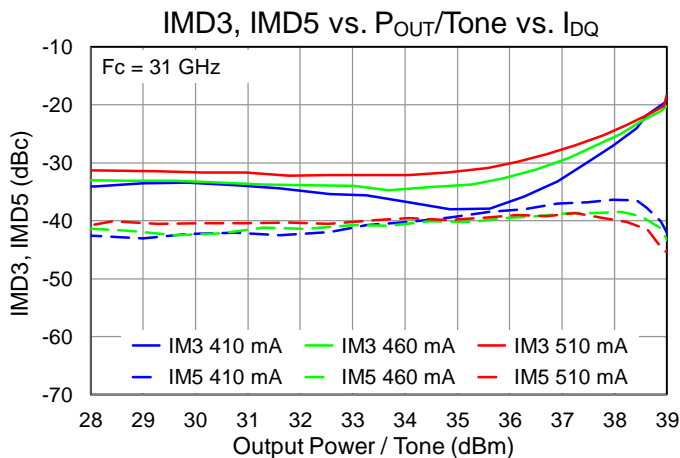
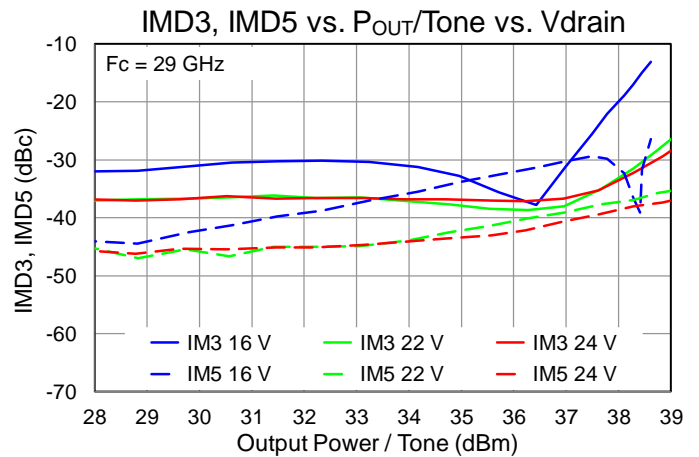
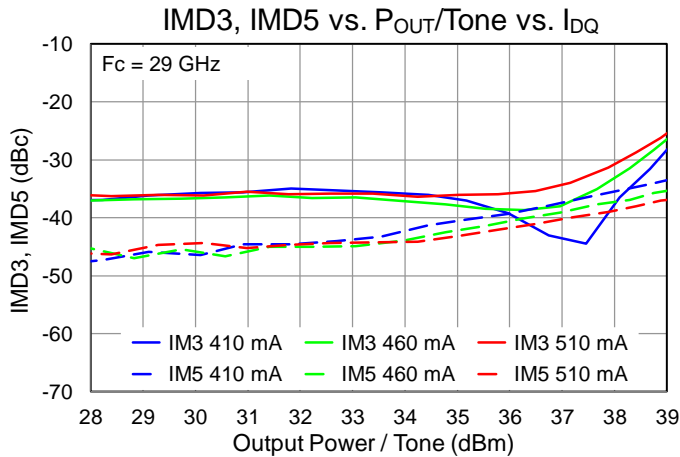
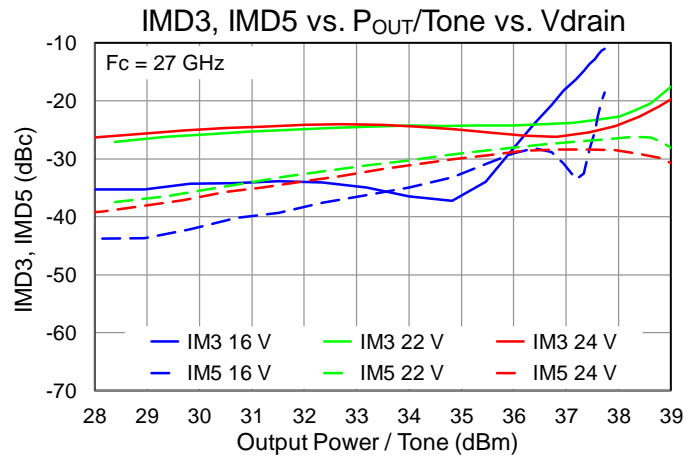
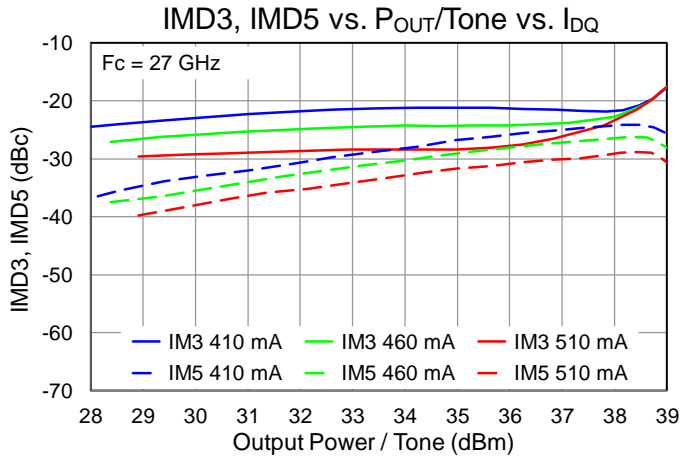

Performance Plots – Linearity

Test conditions, unless otherwise noted: $V_D = 22\text{ V}$, $I_{DQ} = 460\text{ mA}$, $T = +25\text{ }^\circ\text{C}$, 10 MHz tone spacing
All performance data presented is for the QPA2212D (bare die)

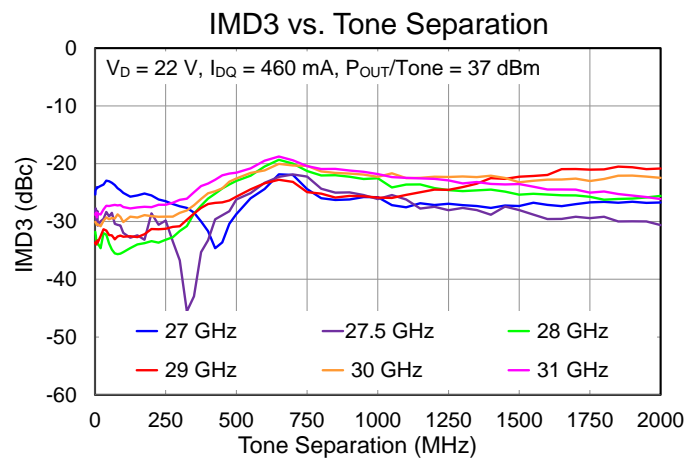
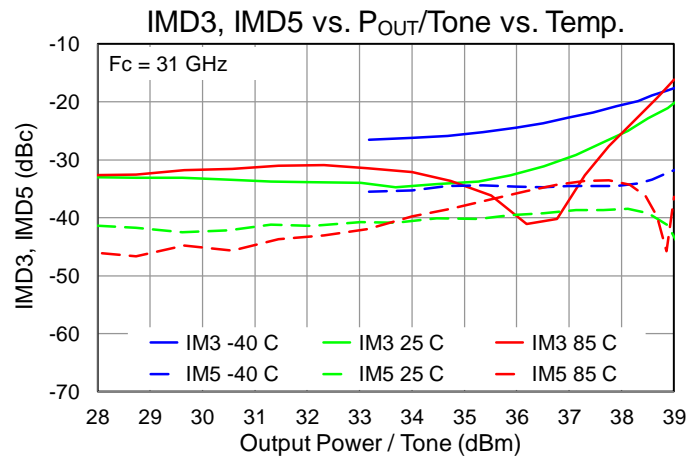
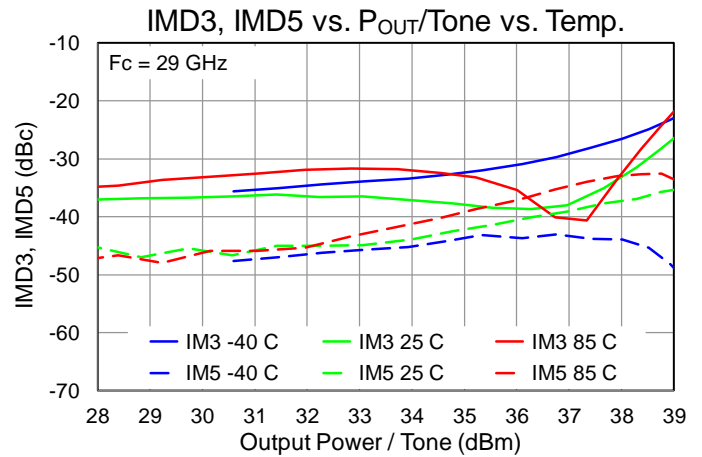
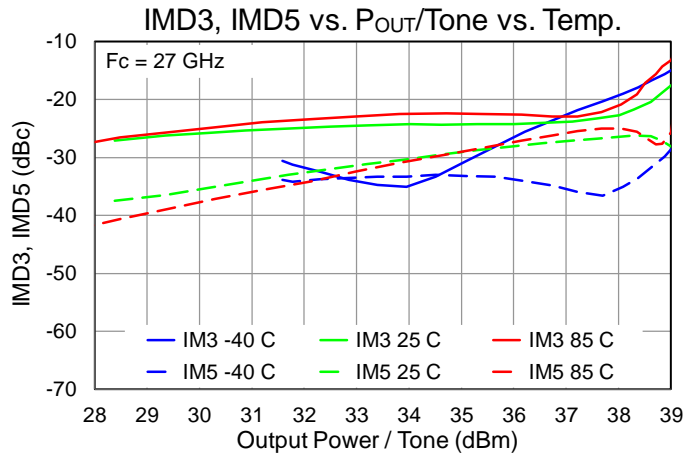

Performance Plots – Small Signal

Test conditions, unless otherwise noted: $V_D = 22\text{ V}$, $I_{DQ} = 460\text{ mA}$, $T = +25\text{ }^\circ\text{C}$
All performance data presented is for the QPA2212D (bare die)

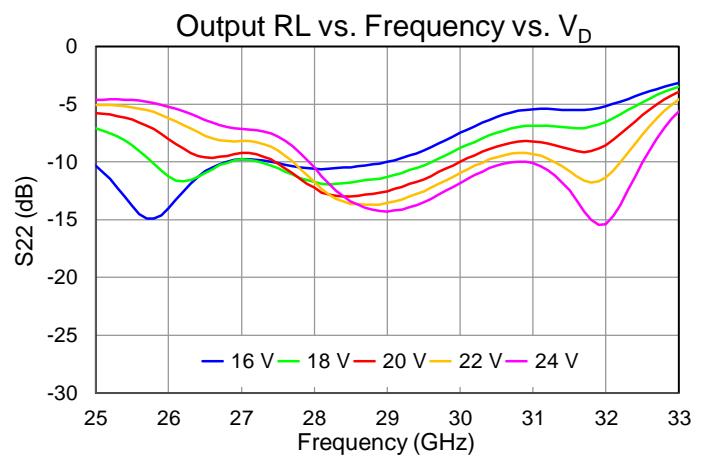
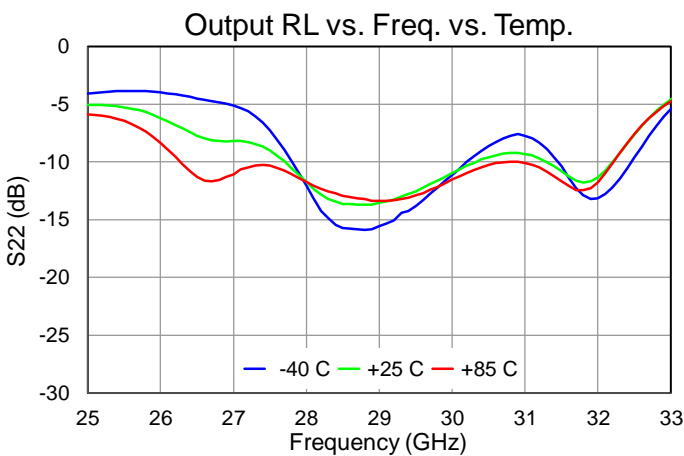
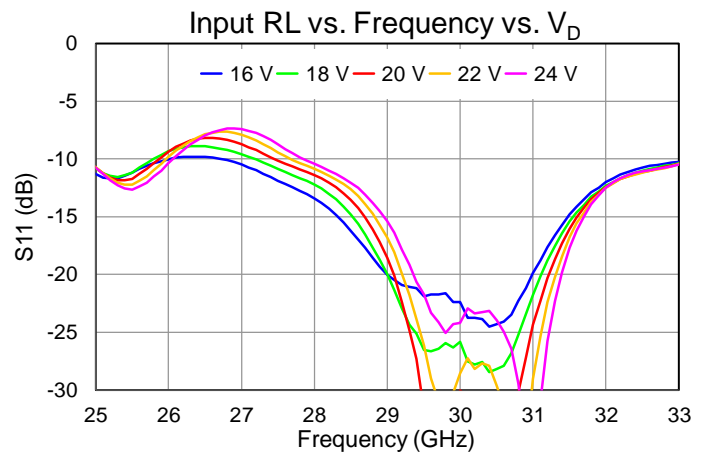
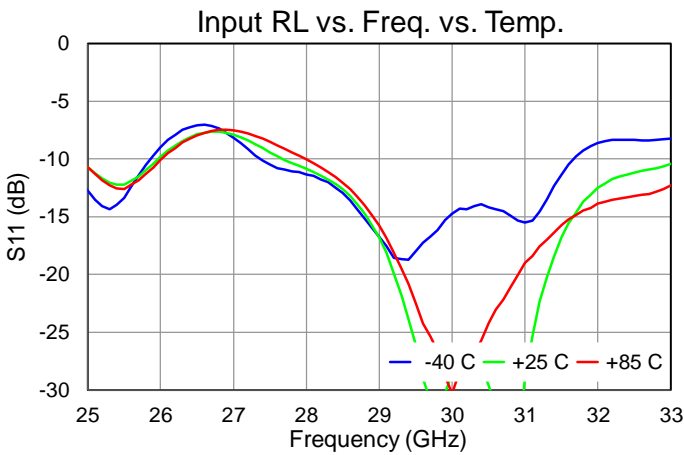
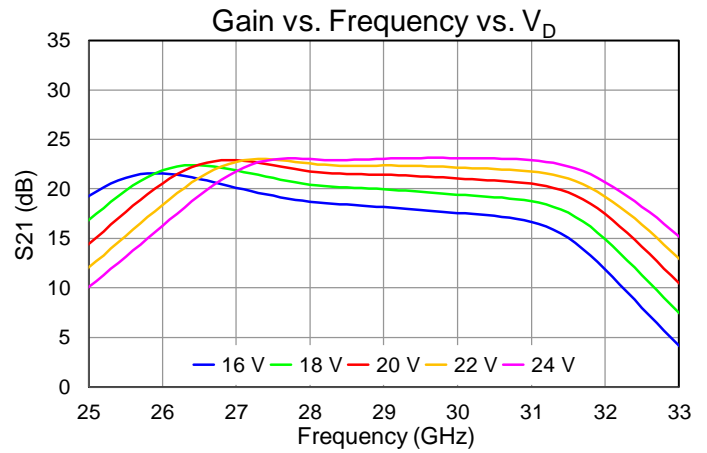
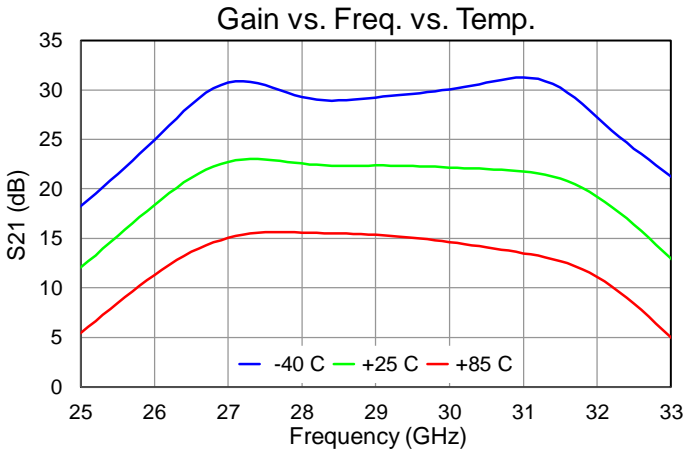

Performance Plots – Small Signal

Test conditions, unless otherwise noted: $V_D = 22\text{ V}$, $I_{DQ} = 460\text{ mA}$, $T = +25\text{ }^\circ\text{C}$
All performance data presented is for the QPA2212D (bare die)

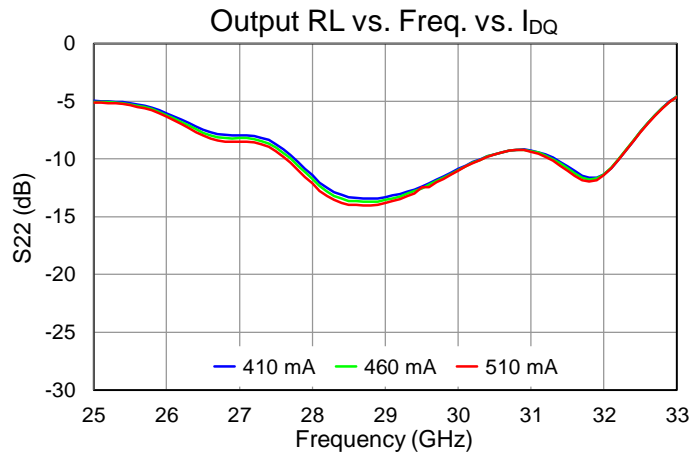
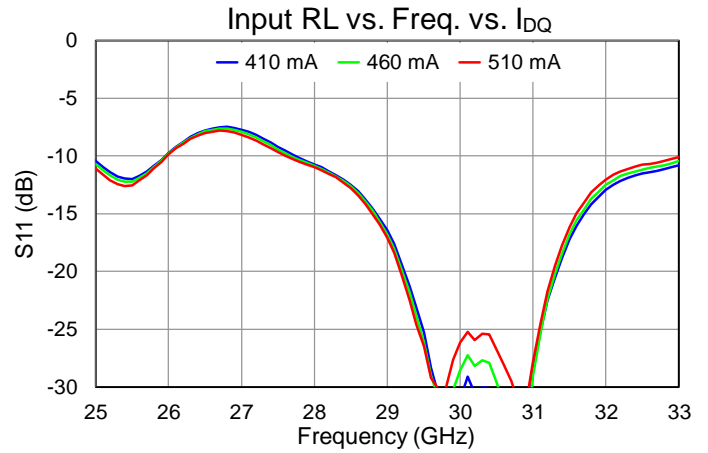
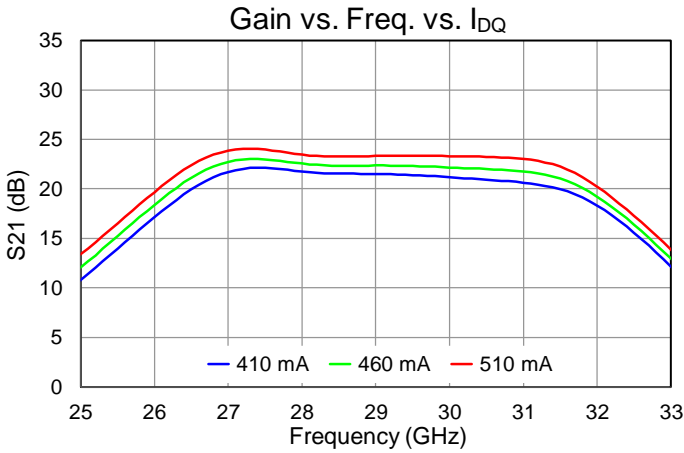

Thermal and Reliability Information

Parameter	Test Conditions	Value	Units
Thermal Resistance (θ_{JC}) ⁽¹⁾	$T_{base} = 85\text{ }^\circ\text{C}$, $V_D = 22\text{ V}$, $I_{DQ} = 460\text{ mA}$, $P_{DISS} = 10.12\text{ W}$, No RF (quiescent DC operation)	1.077	$^\circ\text{C/W}$
Channel Temperature, T_{CH} (No RF) ⁽²⁾		95.9	$^\circ\text{C}$
Thermal Resistance (θ_{JC}) ⁽¹⁾	$T_{base} = 85\text{ }^\circ\text{C}$, $V_D = 22\text{ V}$, $I_{DQ} = 460\text{ mA}$, $\text{Freq} = 28.5\text{ GHz}$, $I_{D_Drive} = 3.41\text{ A}$, $P_{IN} = 25\text{ dBm}$, $P_{OUT} = 42.3\text{ dBm}$, $P_{DISS} = 58.6\text{ W}$	1.392	$^\circ\text{C/W}$
Channel Temperature, T_{CH} (Under RF) ⁽²⁾		166.6	$^\circ\text{C}$
Thermal Resistance (θ_{JC}) ⁽¹⁾	$T_{base} = 85\text{ }^\circ\text{C}$, $V_D = 24\text{ V}$, $I_{DQ} = 460\text{ mA}$, $\text{Freq} = 28.5\text{ GHz}$, $I_{D_Drive} = 3.71\text{ A}$, $P_{IN} = 25\text{ dBm}$, $P_{OUT} = 42.9\text{ dBm}$, $P_{DISS} = 70.1\text{ W}$	1.432	$^\circ\text{C/W}$
Channel Temperature, T_{CH} (Under RF) ⁽²⁾		185.4	$^\circ\text{C}$

Notes:

1. Thermal resistance determined to the back of 20 mil CuMo carrier plate (85 °C)
2. Data shown for QPA2212D (bare die) mounted onto 20 mil Cu-Mo carrier
3. IR scan equivalent. Refer to the following document: [GaN Device Channel Temperature, Thermal Resistance, and Reliability Estimates](#)

Dissipated Power and Maximum Gate Current

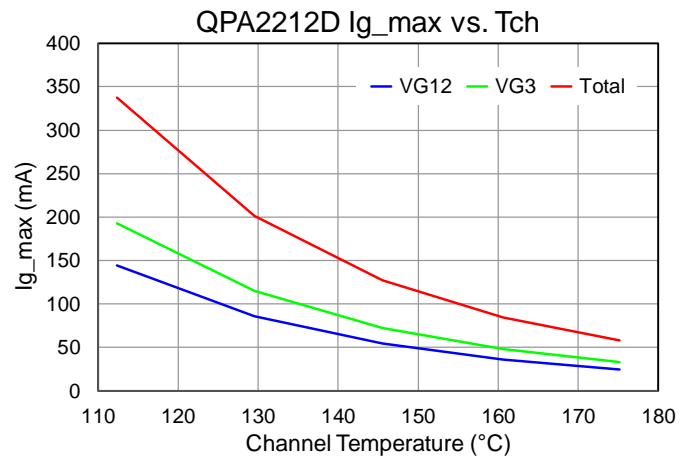
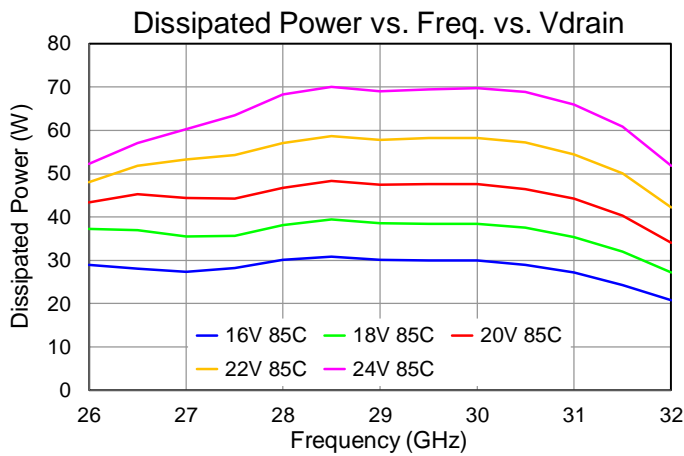

Test conditions, unless otherwise noted:
 $I_{DQ} = 460\text{ mA}$, $T = +85\text{ }^\circ\text{C}$, $P_{IN} = 25\text{ dBm}$

Applications Information

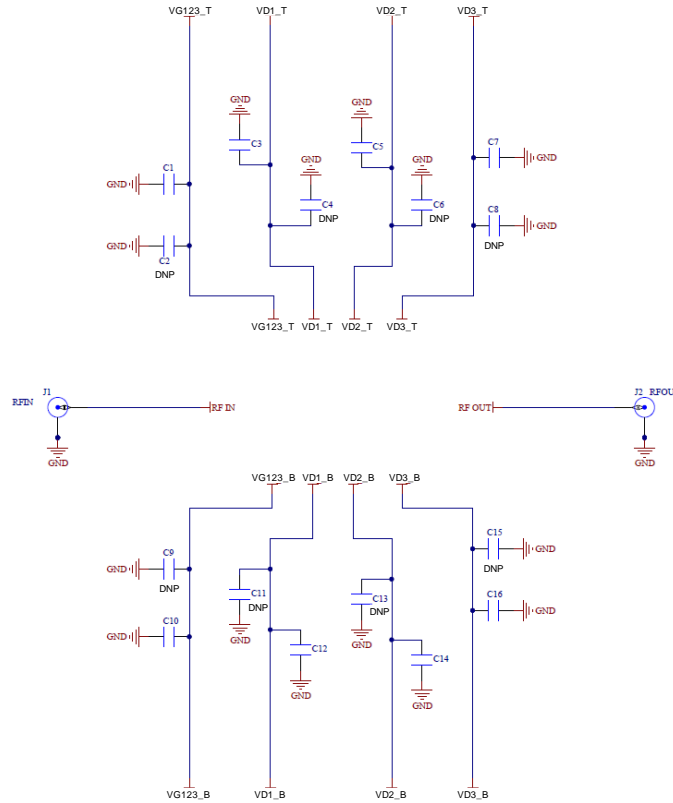

V_{G_TOP} and V_{G_BOTTOM} should be tied together
 V_{D_TOP} and V_{D_BOTTOM} should be tied together

V_{G12} and V_{G3} can be separated, if desired, in an attempt to improve IMD performance, but are connected on the EVB.

Bill of Materials

Reference Des.	Value	Description	Manuf.	Part Number
C1,C3,C5,C7,C10,C12,C14,C16	10 uF	CAP, 10uF, 20%, 50V, 20%, X5R, 1206	Various	
C17,C18,C19,C20,C21,C22,C23,C24	10 nF	CAP, 10nF, 15%, 30V, 0303, SLC Si WP	Various	
J1, J2	2.4 mm	RF Connector, 2.4 mm	SW Microwave	1492-04A-5

Note: Schematic and components based on the EVB for the QPA2212D (bare die)

Evaluation Board (EVB) Layout Assembly

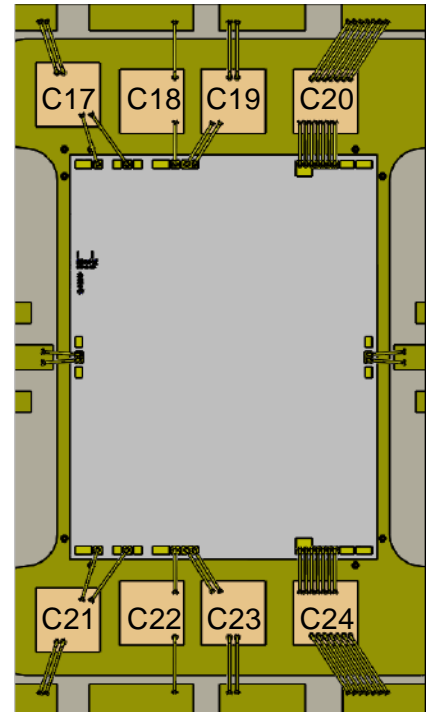
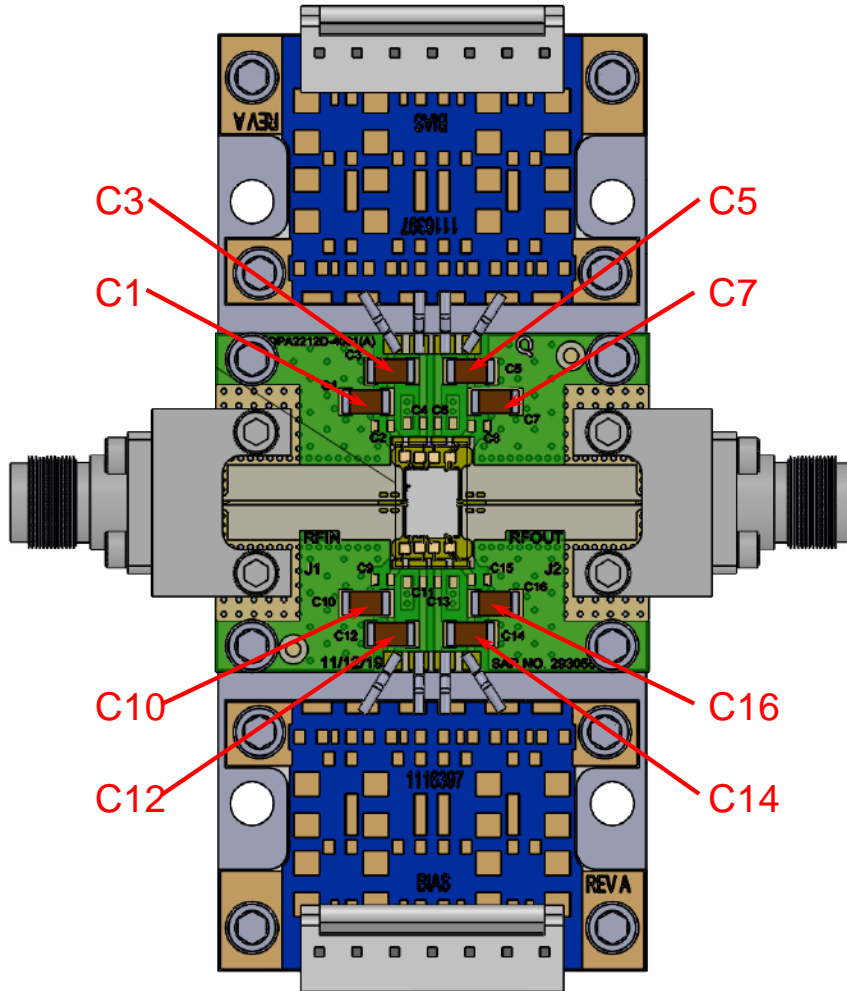

Die and capacitor placement and bonding detail

PCB is made from Rogers 6202 dielectric, .005 inch thick, 0.5 oz. copper both sides.

Note: EVB shown is for the QPA2212D; there is no EVB available for the QPA2212T.

Bias-Up Procedure

1. Set I_D limit to 5500 mA, I_G limit to 40 mA
2. Set V_G to -5.0 V
3. Set V_D +22 V
4. Adjust V_G more positive until $I_{DQ} \approx 460$ mA
5. Apply RF signal

Bias-Down Procedure

1. Turn off RF signal
2. Reduce V_G to -5.0 V. Ensure $I_{DQ} \sim 0$ mA
4. Set V_D to 0 V
5. Turn off V_D supply
6. Turn off V_G supply

Mechanical Drawing and Bond Pad Description (MMIC Only)

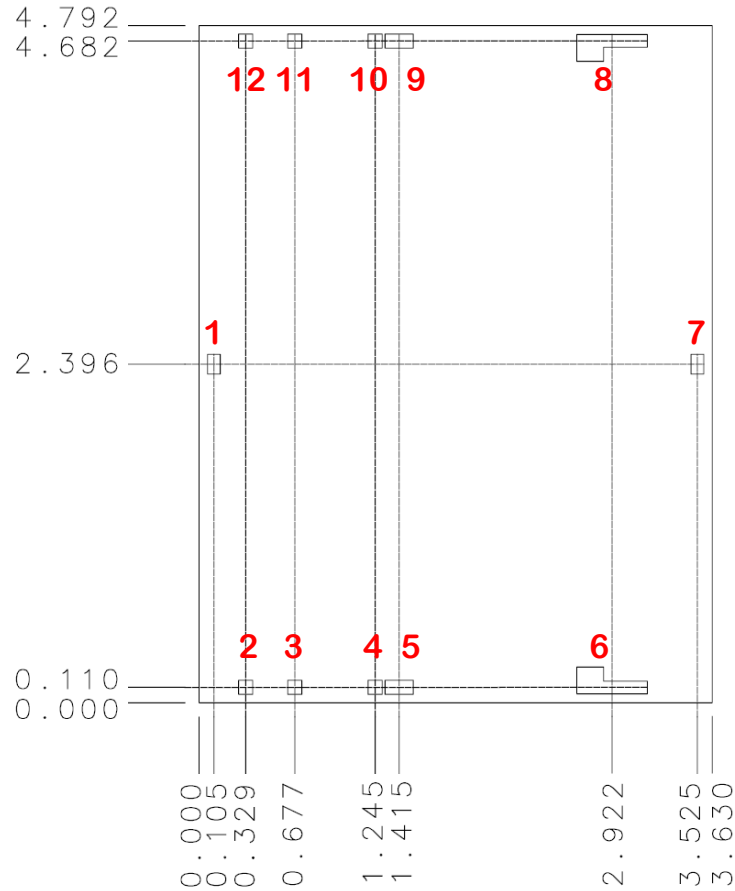

Dimensions are in mm
 Thickness: 0.050
 Die x, y size tolerance: ± 0.050
 Ground is backside of die

Bond Pad Description

Pad No.	Symbol	Size (um x um)	Description
1	RF IN	90 x 140	RF input. 50 Ohms. DC grounded.
2, 12	V _{G12}	100 x 100	Gate voltage stages 1 & 2. Bypass network required; refer to page 18.
3, 11	V _{G3}	100 x 100	Gate voltage stage3. Bypass network required; refer to page 18.
4, 10	V _{D1}	100 x 100	Drain voltage stages 1. Bypass network required; refer to page 18.
5, 9	V _{D2}	200 x 100	Drain voltage stage 2. Bypass network required; refer to page 18.
6, 8	V _{D3}	500 x 90	Drain voltage stage 3. Bypass network required; refer to page 18.
7	RF OUT	90 x 140	RF output. 50 Ohms. DC grounded.

Mechanical Drawing (Die on Tab)

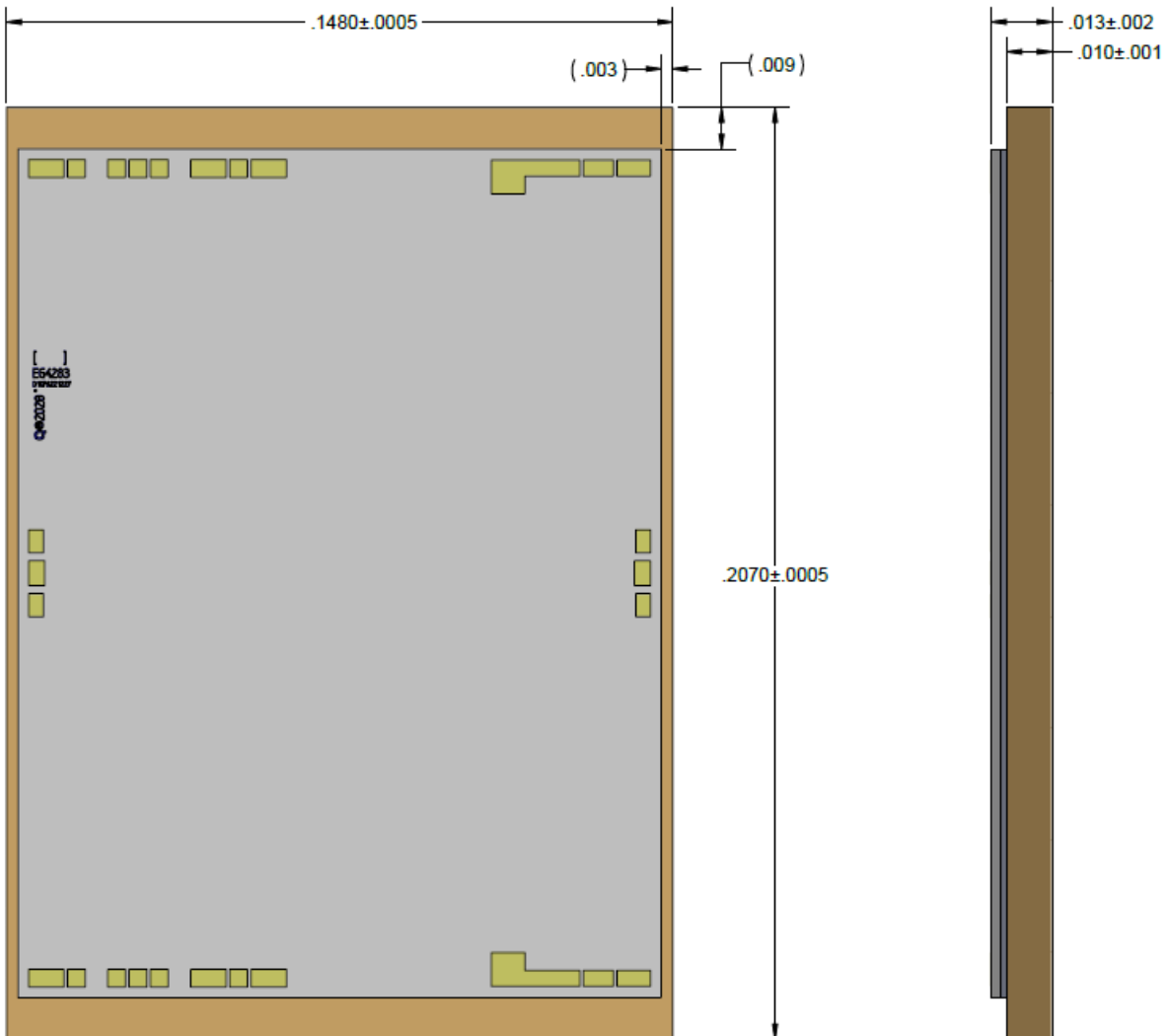

Notes:

1. Dimensions are in inches
2. Thermal spreader material: Cu-Mo
3. Plating: Gold

Assembly Notes

Component placement and adhesive attachment assembly notes:

- Vacuum pencils and/or vacuum collets are the preferred method of pick up.
- Air bridges must be avoided during placement.
- The force impact is critical during auto placement.

Interconnect process assembly notes:

- Thermosonic ball bonding is the preferred interconnect technique.
- Force, time, and ultrasonic are critical parameters.
- Aluminum wire should not be used.
- Devices with small pad sizes should be bonded with 0.0007-inch wire.
- Maximum stage temperature is 200 °C.

Handling Precautions

Parameter	Rating	Standard
ESD – Human Body Model (HBM)	1C	ANSI/ESD/JEDEC JS-001



Caution!
 ESD-Sensitive Device

RoHS Compliance

This part is compliant with 2011/65/EU RoHS directive (Restrictions on the Use of Certain Hazardous Substances in Electrical and Electronic Equipment) as amended by Directive 2015/863/EU.

This product also has the following attributes:

- Lead Free
- Halogen Free (Chlorine, Bromine)
- Antimony Free
- TBBP-A (C₁₅H₁₂Br₄O₂) Free
- PFOS Free
- SVHC Free

Contact Information

For the latest specifications, additional product information, worldwide sales and distribution locations:

Web: www.qorvo.com

Tel: 1-844-890-8163

Email: customer.support@qorvo.com

Important Notice

The information contained herein is believed to be reliable; however, Qorvo makes no warranties regarding the information contained herein and assumes no responsibility or liability whatsoever for the use of the information contained herein. All information contained herein is subject to change without notice. Customers should obtain and verify the latest relevant information before placing orders for Qorvo products. The information contained herein or any use of such information does not grant, explicitly or implicitly, to any party any patent rights, licenses, or any other intellectual property rights, whether with regard to such information itself or anything described by such information. **THIS INFORMATION DOES NOT CONSTITUTE A WARRANTY WITH RESPECT TO THE PRODUCTS DESCRIBED HEREIN, AND QORVO HEREBY DISCLAIMS ANY AND ALL WARRANTIES WITH RESPECT TO SUCH PRODUCTS WHETHER EXPRESS OR IMPLIED BY LAW, COURSE OF DEALING, COURSE OF PERFORMANCE, USAGE OF TRADE OR OTHERWISE, INCLUDING THE IMPLIED WARRANTIES OF MERCHANTABILITY AND FITNESS FOR A PARTICULAR PURPOSE.**

Without limiting the generality of the foregoing, Qorvo products are not warranted or authorized for use as critical components in medical, life-saving, or life-sustaining applications, or other applications where a failure would reasonably be expected to cause severe personal injury or death.

© 2021 Qorvo US, Inc. All rights reserved. This document is subject to copyright laws in various jurisdictions worldwide and may not be reproduced or distributed, in whole or in part, without the express written consent of Qorvo US, Inc.

Looking for pricing, stock, or lifecycle information?

Click below to explore more details on WIN SOURCE:

 [View QPA2212T on WIN SOURCE](#)

 [Qorvo US Inc. Information](#)

Optimize Your Supply Chain with WIN SOURCE Solutions

-  Global Sourcing Solution
-  Obsolete Management
-  Cost Control Management
-  Shortage Management
-  Alternative Solution
-  Excess Inventory Management