

Features

Unregulated Converters

- Industry standard pinout
- 1kVDC/1s or 2kVDC/1s isolation
- UL94 V-0 package material
- Fully encapsulated
- Efficiency up to 85%



RO

1 Watt
SIP4
Single Output



Description

The RO DC/DC converters are typically used in general purpose power isolation and voltage matching applications, and feature a full industrial operating temperature range of -40°C to +85°C without derating.

Selection Guide

Part Number	nom. Input Voltage [VDC]	Output Voltage [VDC]	Output Current [mA]	Efficiency typ. ⁽¹⁾ [%]	max. Capacitive Load ⁽²⁾ [μF]
RO-xx3.3S ^(3,4)	3.3, 5, 12, 15, 24	3.3	303	75	2200
RO-xx05S ^(3,4)	3.3, 5, 12, 15, 24	5	200	78-80	1000
RO-xx09S ^(3,4)	3.3, 5, 12, 15, 24	9	111	78-80	1000
RO-xx12S ^(3,4)	3.3, 5, 12, 15, 24	12	83	80-84	470
RO-xx15S ^(3,4)	3.3, 5, 12, 15, 24	15	66	80-84	470
RO-xx24S ^(3,4)	3.3, 5, 12, 15, 24	24	42	78-85	220

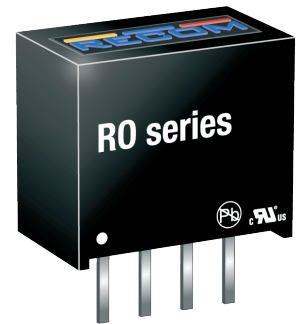

Notes:

- Note1: Efficiency is tested at nominal input and full load at +25°C ambient
 Note2: Max Cap Load is tested at nominal input and full resistive load and is defined as the capacitive load that will allow start up in under 1s without damage to the converter



Model Numbering

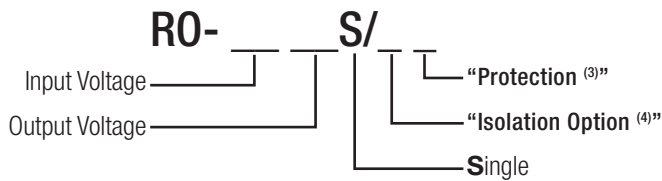

Notes:

- Note3: standard part is without continuous short circuit protection
 add suffix „/P“ for continuous short circuit protection
 Note4: add suffix „/H“ for 2kVDC/1s isolation
 or add suffix „/HP“ for continuous short circuit protection and 2kVDC/1s isolation

UL60950-1 certified
 CAN/CSA-C22.2 No 60950-1 certified
 EN60950-1 certified
 IEC60950-1 certified
 EN55032 compliant
 CB report

Ordering Examples:

RO-123.3S/P: 12VDC Input Voltage, 3.3VDC Output Voltage, Single Output with continuous short circuit protection
 RO-0509S/HP: 5VDC Input Voltage, 9VDC Output Voltage, Single Output with 2kVDC/1s Isolation and continuous short circuit protection

Specifications (measured @ Ta= 25°C, nom. Vin, full load unless otherwise stated)

BASIC CHARACTERISTICS

Parameter	Condition	Min.	Typ.	Max.
Internal Input Filter				capacitor
Input Voltage Range			±10%	
Minimum Load		0%		
Internal Operating Frequency		50kHz	100kHz	105kHz
Output Ripple and Noise	20MHz BW			100mVp-p

Efficiency vs. Load

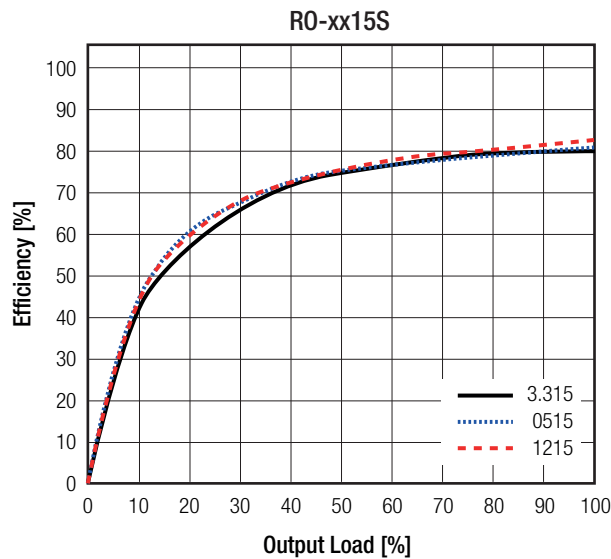
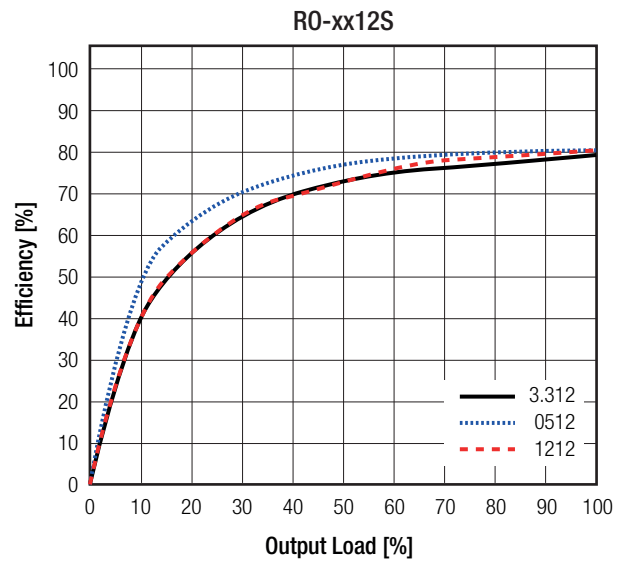
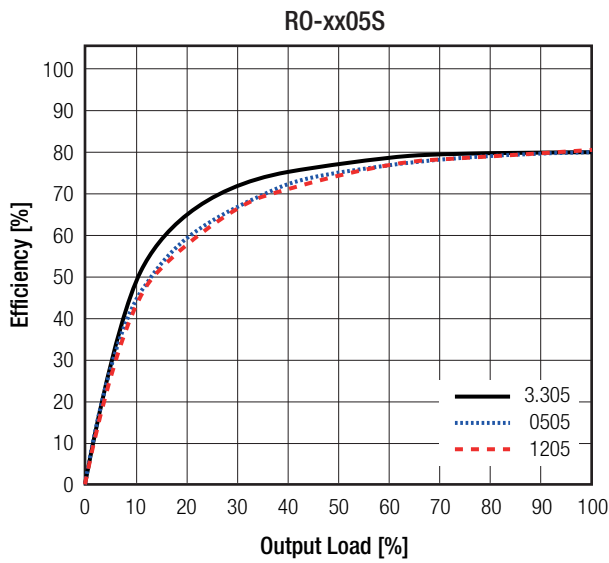

REGULATIONS

Parameter	Condition	Value
Output Accuracy		-2.0% typ. / ±5.0% max.
Line Regulation	low line to high line	±1.2% of 1.0% Vin typ.

continued on next page

Specifications (measured @ Ta= 25°C, nom. Vin, full load unless otherwise stated)

Parameter	Condition		Value
Load Regulation ⁽⁵⁾	10% to 100% load	3.3Vout	20.0% max.
		5Vout	15.0% max.
		12, 15, 24Vout	10.0% max.

Notes:

Note5: Operation below 10% load will not harm the converter, but specifications may not be met

Tolerance Envelope

RO-xx3.3S and RO-xx05S

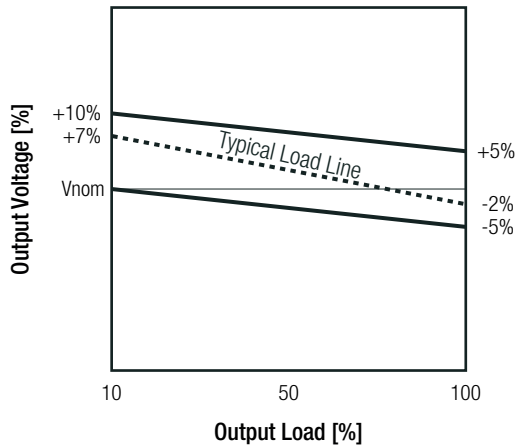

RO-xx12S and RO-xx15S

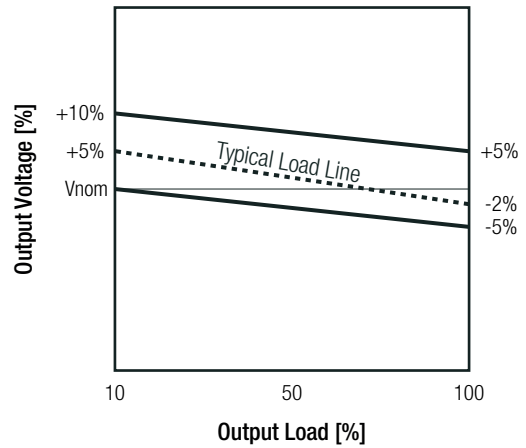

Deviation vs. Load

RO-xx05S

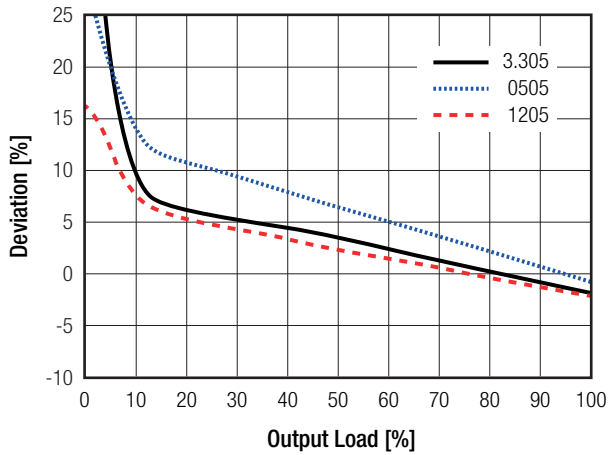

RO-xx12S

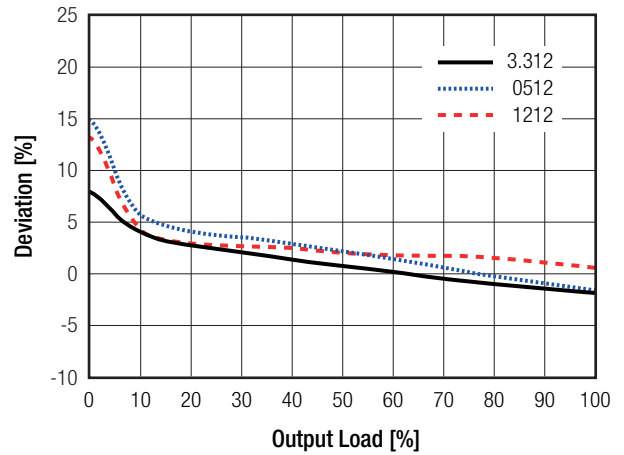

RO-xx15S

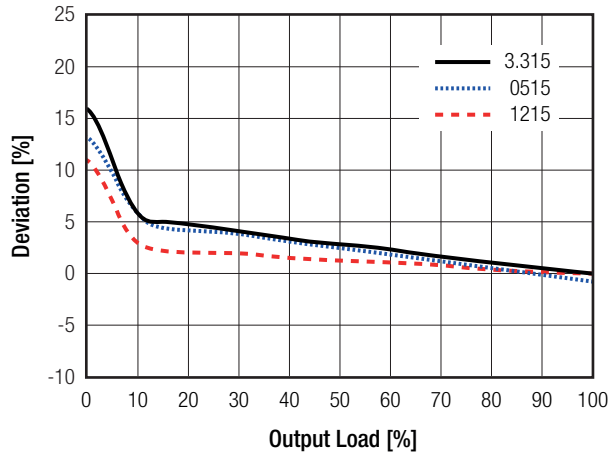

Specifications (measured @ Ta= 25°C, nom. Vin, full load unless otherwise stated)

PROTECTIONS

Parameter	Type		Value
Short Circuit Protection (SCP)	without suffix with suffix "/P"		1 second continuous
Isolation Voltage ⁽⁶⁾	I/P to O/P	without suffix	tested for 1 second rated for 1 minute 1kVDC 500VAC/60Hz
		with suffix "/H"	tested for 1 second rated for 1 minute 2kVDC 1kVAC/60Hz
Isolation Resistance			10GΩ min.
Isolation Capacitance			20pF min. / 75pF max.
Insulation Grade			basic (IEC/EN60950-1) functional (IEC/EN60601-1)
<p>Notes:</p> <p>Note6: For repeat Hi-Pot testing, reduce the time and/or the test voltage</p> <p>Note7: Refer to local safety regulations if input over-current protection is also required. Recommended fuse: slow blow type</p>			

ENVIRONMENTAL

Parameter	Condition		Value
Operating Temperature Range	full load (see graph)		-40°C to +85°C
Maximum Case Temperature			+110°C
Temperature Coefficient			±0.03%/K typ.
Thermal Impedance			67K/W
Operating Altitude			2000m (IEC/EN60950-1) 3000m (IEC/EN60601-1)
Operating Humidity	non-condensing		95% RH max.
Pollution Degree			PD2
MTBF	according to MIL-HDBK-217F, G.B.	+25°C	11800 x 10 ³ hours
		+85°C	4800 x 10 ³ hours

Derating Graph

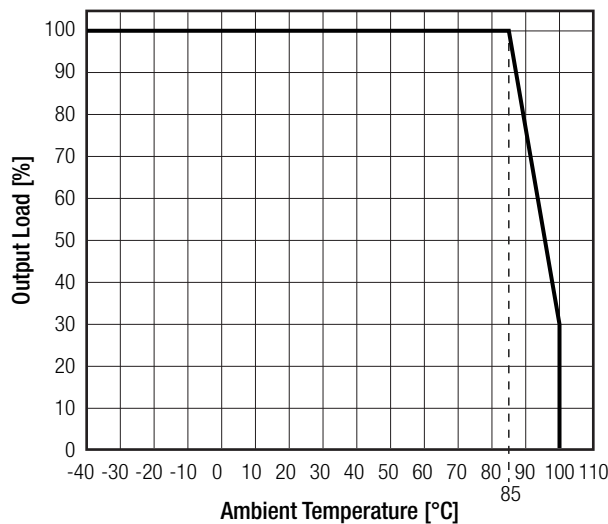

Specifications (measured @ Ta= 25°C, nom. Vin, full load unless otherwise stated)

SAFETY AND CERTIFICATIONS

Certificate Type (Safety)	Report / File Number	Standard
Information Technology Equipment, General Requirements for Safety	LVD1602031	IEC60950-1:2005, 2nd Edition + A2:2013 EN60950-1:2006 + A2:2013
Information Technology Equipment, General Requirements for Safety	E358085-A4-UL	UL60950-1, 2nd Edition:2007 CAN/CSA C22.2 No. 60950-1-03, 2nd Edition:2007
Information Technology Equipment, General Requirements for Safety (CB)	E322406-A4-CB-1	IEC60950-1:2005, 2nd Edition
Medical electrical equipment Part 1: General requirements for basic safety and essential performance	WD-SE-R-180677-A0	EN60601-1:2006 + A12:2014 IEC60601-1:2005 + A1:2012, 3rd Edition
EAC	RU-AT.49.09571	TP TC 004/2011
RoHS 2		RoHS-2011/65/EU + AM-2015/863

EMC Compliance

EMC Compliance	Condition	Standard / Criterion
Electromagnetic compatibility of multimedia equipment - Emission requirements	with external filter (see filter suggestion below)	EN55032, Class A and B

EMC Filter Suggestion according to EN55032

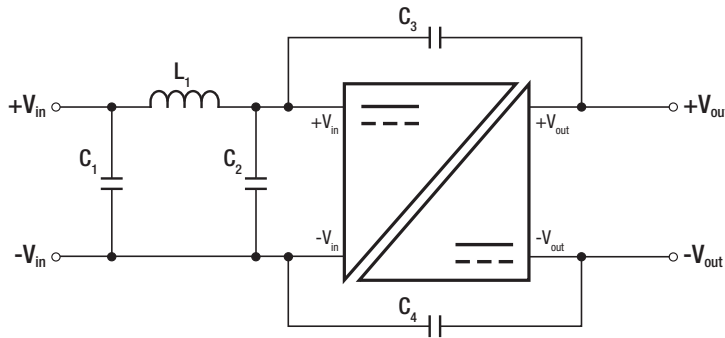

Component List Class A

MODEL	C1	L1	C2	C4 (safety)
RO-0505S	10µF 100V MLCC	N/A	1nF 50V MLCC	N/A
RO-1205S				2.2nF
RO-2405S				N/A

Component List Class B

MODEL	C1	L1	C3 (safety)	C4 (safety)
RO-0505S	10µF 100V MLCC	22µH choke RLS-226	1nF	2.2nF
RO-1205S				
RO-2405S				

Notes:

Note8: Filter suggestions are valid for indicated part numbers only. For other part numbers, please contact RECOM tech support for advice

DIMENSION AND PHYSICAL CHARACTERISTICS

Parameter	Type	Value
Material	case potting PCB	non-conductive black plastic, (UL94V-0) epoxy, (UL94V-0) FR4, (UL94V-0)
Dimension (LxWxH)		11.5 x 6.0 x 10.0mm
Weight		1.4g typ.

continued on next page

Specifications (measured @ Ta= 25°C, nom. Vin, full load unless otherwise stated)

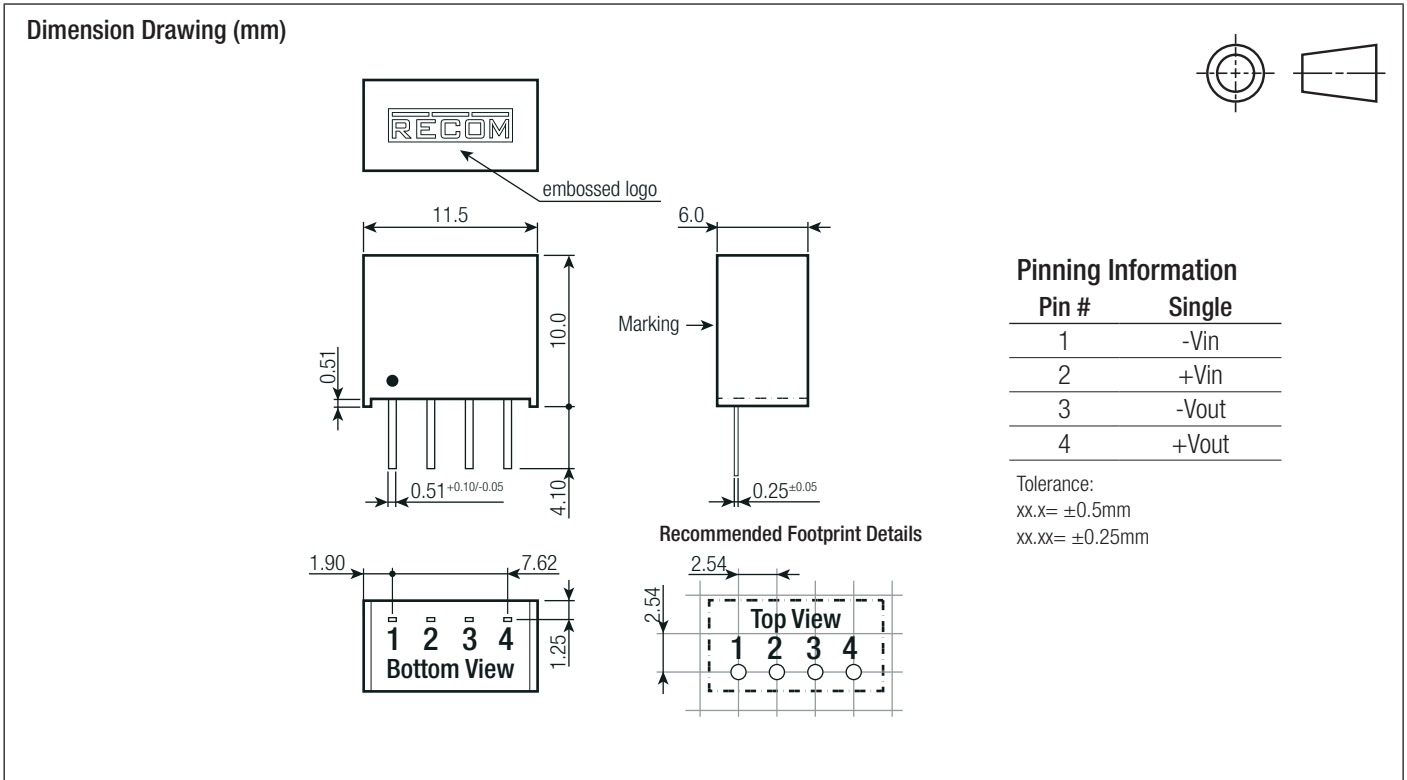

INSTALLATION AND APPLICATION

Typical Application

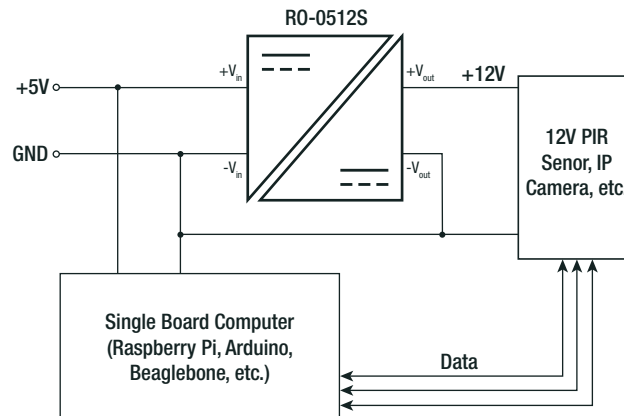



PACKAGING INFORMATION

Parameter	Type	Value
Packaging Dimension (LxWxH)	tube	520.0 x 16.0 x 9.0mm
Packaging Quantity	tube	42pcs
Storage Temperature Range		-55°C to +125°C
Storage Humidity	non-condensing	95% RH max.

The product information and specifications may be subject to changes even without prior written notice. The product has been designed for various applications; its suitability lies in the responsibility of each customer. The products are not authorized for use in safety-critical applications without RECOM's explicit written consent. A safety-critical application is an application where a failure may reasonably be expected to endanger or cause loss of life, inflict bodily harm or damage property. The applicant shall indemnify and hold harmless RECOM, its affiliated companies and its representatives against any damage claims in connection with the unauthorized use of RECOM products in such safety-critical applications.

Looking for pricing, stock, or lifecycle information?

Click below to explore more details on WIN SOURCE:

-  [View RO-2412S on WIN SOURCE](#)
-  [Recom Power Information](#)

Optimize Your Supply Chain with WIN SOURCE Solutions

-  Global Sourcing Solution
-  Obsolete Management
-  Cost Control Management
-  Shortage Management
-  Alternative Solution
-  Excess Inventory Management