

Product Description

The MYMGK1R806FRSR and MYMGK00506ERSR are miniature MonoBK™ (Mono Block) non-isolated Point-of-Load (PoL) DC-DC power converters designed for embedded applications.

The modules have a small form factor, measuring only 9.0 × 7.5 × 5.0 mm. Typical applications include powering FPGAs, CPUs, datacom and telecom systems, Distributed Bus Architectures (DBA), programmable logic devices, and mixed-voltage systems.

The converters operate over input voltage ranges of 4.5 to 15.0V for the MYMGK1R806FRSR and 8.0 to 15.0V for the MYMGK00506ERSR, with a maximum output current of 6 A. Based on a fixed frequency synchronous buck converter switching topology, this high-power conversion efficient PoL module features settable output voltage 0.6 to 5.0V (MYMGK1R806FRSR) or 0.7 to 5.0V (MYMGK00506ERSR), On/Off control and Power Good signal output.

These converters also include undervoltage lockout (UVLO), output short circuit protection and over-current protection.

Features

- Settable output voltage range
 - MYMGK1R806FRSR: 0.6 to 5.0V
 - MYMGK00506ERSR: 0.7 to 5.0V
- Up to 6A of output current
- Quick response to load change
- Small surface mount package
9.0 x 7.5 x 5.0 mm
- High efficiency of 97.5%
- Outstanding thermal derating performance
- Over current protection
- On/Off control (Positive logic)
- Power Good signal
- High Reliability / Heat Shock Testing
700 cycle (-40 to +125degC)
- Meets CISPR 22 class B conducted emission

Typical Applications

- PCIe / Server applications
- FPGA and DSP
- Datacom / Telecom systems
- Distributed bus architectures (DBA)
- Programmable logic and mixed voltage

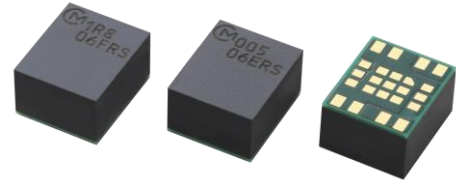

Efficiency

$V_{IN} = 5V, V_{OUT} = 1.0V, T_A = 25degC$
 $V_{IN} = 12V, V_{OUT} = 1.0V, T_A = 25degC$
 $V_{IN} = 12V, V_{OUT} = 5.0V, T_A = 25degC$

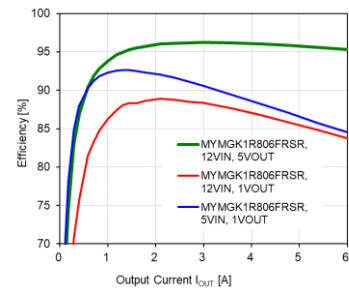

(a)MYMGK1R806FRSR

$V_{IN} = 12V, V_{OUT} = 5.0V, T_A = 25degC$
 $V_{IN} = 12V, V_{OUT} = 1.0V, T_A = 25degC$

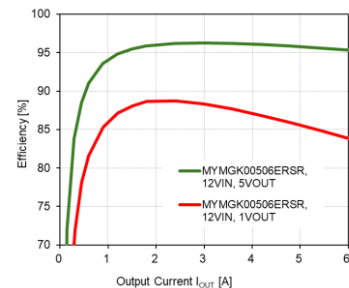

(b)MYMGK00506ERSR

Figure 1. Efficiency Curve

Simplified Application Circuit

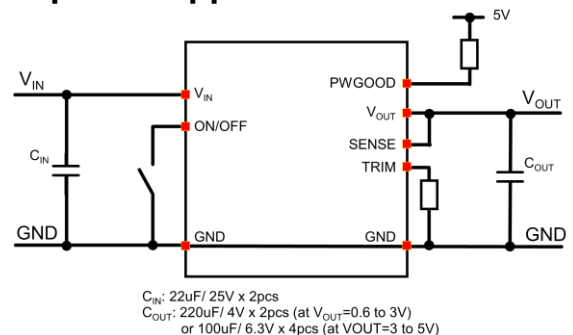

Figure 2. Simplified Circuit Diagram

Product Description 1

Features 1

Typical Applications..... 1

Simplified Application Circuit 1

Performance Specifications Summary and Ordering Information 3

Top Marking Specifications 3

Pin Configuration..... 4
Pin Function and Descriptions4

Absolute Maximum Ratings..... 5

Recommended Operating Conditions 5

Package Thermal Characteristics 5

Electrical Characteristics 6
Electrical Characteristics Table.....6

Typical Performance Characteristics 9
Thermal Deratings (Reference Data).....18
Transient Response Data18

Test Circuit..... 19

Detailed Description..... 20
Input Under-Voltage Shutdown and Start-Up Threshold.....20
Start-Up Time.....20
Output Noise20
Minimum Output Loading Requirements21
Thermal Shutdown21
Temperature Derating Curves21
Output Current Limiting.....21
Output Short Circuit Condition21
Power Good (PWGOOD).....21
UVP/OVP Function22
Enable (ON/OFF).....22
Output Capacitive Load23
Output Voltage Adjustment.....23
Output Voltage Remote Sense23

Application Information 24
Application Circuit & Part List.....24
Example of Pattern Layout (Top View).....25
Application Board Example.....25

Component Selection 26
Input Fuse26
Recommended Input Filtering.....26
Recommended Output Filtering.....26

Packaging Information..... 27
Package Drawing27
Recommended Board Land Pattern (Top View).....28

Tape and Reel Information 29
Tape Dimensions29
Reel Dimensions29
Tape Specifications.....30

Soldering Guidelines..... 31
Recommended Lead-free Solder Reflow Profile31
Pb-free Solder Processes31
Dry Pack Information.....31

Notices..... 32
Scope32

CAUTION 32
Limitation of Applications32
Fail-Safe Function.....33

Note 33
Product Specification33
Contact Form33

Disclaimers 34
Patent Statement34
Copyright and Trademark.....34

Performance Specifications Summary and Ordering Information

Table 1. Performance Specifications Summary and Ordering Information

PART NUMBER	OUTPUT		INPUT			Efficiency [%]	EN	Package [mm]	MSL	Quantity/Packing
	V _{OUT} [V]	I _{OUT} (max.) [A]	V _{IN} (typ.) [V]	Range [V]	I _{IN} full load [A]					
MYMGK1R806FRSR	0.6-5.0	6	12	4.5-15.0	2.6	95	Yes (Positive)	9.0 x 7.5 x 5.0 LGA	3	400 units/T&R
MYMGK00506ERSR	0.7-5.0	6	12	8.0-15.0	2.6	95	Yes (Positive)	9.0 x 7.5 x 5.0 LGA	3	400 units/T&R
NRND MYMGK1R806FRSRD	0.6-5.0	6	12	4.5-15.0	2.6	95	Yes (Positive)	9.0 x 7.5 x 5.0 LGA	3	100 units/T&R
NRND MYMGK00506ERSRD	0.7-5.0	6	12	8.0-15.0	2.6	95	Yes (Positive)	9.0 x 7.5 x 5.0 LGA	3	100 units/T&R

- All Specifications are typical at 25degC, V_{IN} = typical 12V, V_{OUT} = typical +5V, full load, external capacitors and natural convection unless otherwise indicated. All models are tested and specified with external 100uF x 4 ceramic output capacitors and 22uF x 2 ceramic and plenty of electrolytic external input capacitors. See detailed specifications. Input and Output capacitors are necessary for our test equipment.
- Use adequate ground plane and copper thickness adjacent to the converter.

Table 2. Part Numbering

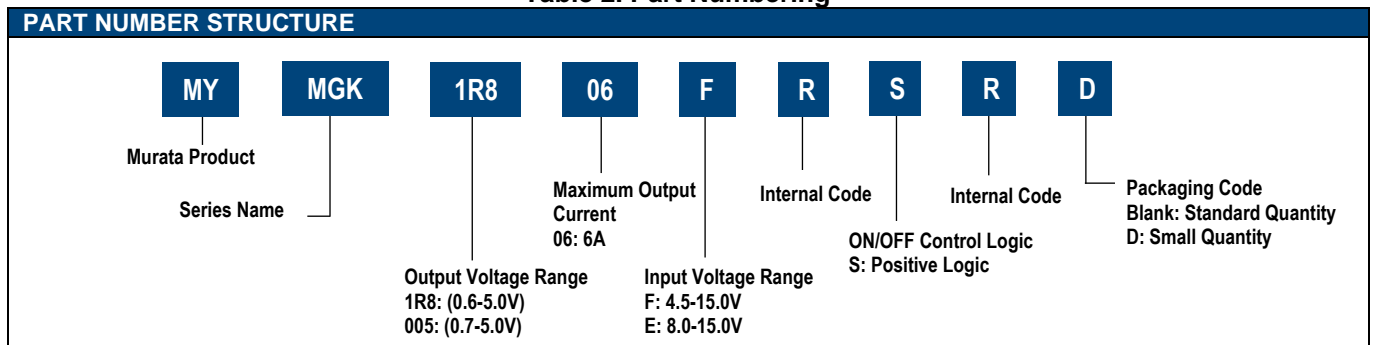

Top Marking Specifications

Because of the small size of these products, the product marking contains a character-reduced code to indicate the model number and manufacturing date code. Not all items on the marking are always used. Please note that the marking differs from the product photograph. Here is the layout of the marking.

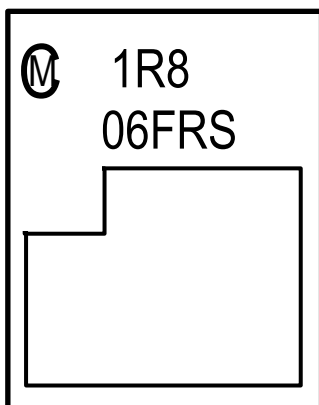

Figure 3. Top Marking Specification

Table 3. Code Description

CODE	DESCRIPTION
Ⓜ	Pin 1 Marking
1R806FRS	Product code (Please see product code table beside)
[]	Internal manufacturing code

Table 4. Product Code Table

PART NUMBER	PRODUCT CODE
MYMGK1R806FRSR	1R806FRS
MYMGK00506ERSR	00506ERS
MYMGK1R806FRSRD	1R806FRS
MYMGK00506ERSRD	00506ERS

Pin Configuration

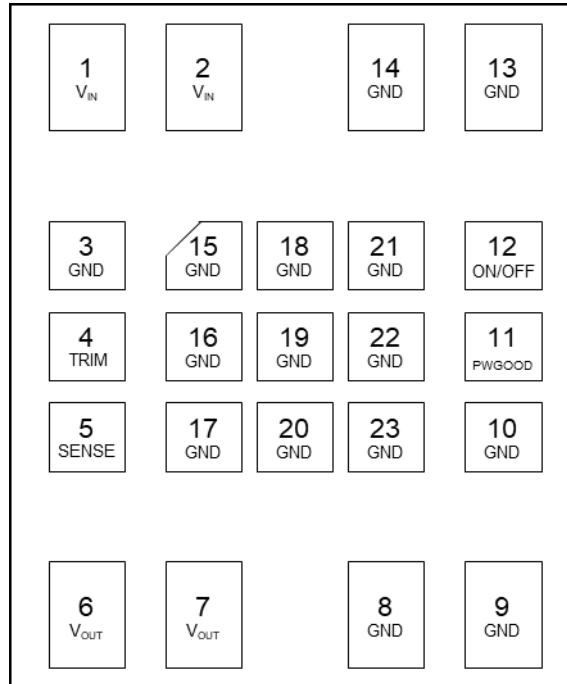

Figure 4. Module Terminals (Top View)

Pin Function and Descriptions

Table 5. Pin Function and Descriptions

PIN No.	NAME	FUNCTION and DESCRIPTION
1, 2	V _{IN}	Power input voltage.
3, 8, 9, 10, 13, 14	GND	Ground pins. Connect to the GND plane.
4	TRIM	Output voltage setting pin. The resistor must be located between GND to set output voltage correctly.
5	SENSE	Output Voltage Sensing pin. Connect to an output near the load to improve load regulation. This pin must be connected to output near the load, or at the module pins.
6, 7	V _{OUT}	Power output voltage.
11	PWGOOD	Power good output. The output of PWGOOD is an open-drain signal. PWGOOD requires a pull-up resistor connected to a DC voltage to indicate high when the output voltage becomes within +10% and –5% of the target value. There is a PWGOOD delay around 1msec from low to high.
12	ON/OFF	Remote ON/OFF pin. The module can be turned ON or OFF using this pin. It is internally connected to the input voltage (V _{IN}) through a resistor. When the ON/OFF pin is connected to ground, the module is turned OFF (disabled).
15, 16, 17, 18, 19, 21, 22, 23	GND (Thermal Pad)	Ground pins. Connect to the GND plane.

Absolute Maximum Ratings ⁽¹⁾⁽²⁾

Table 6. Absolute Maximum Ratings

PARAMETER		MIN	MAX	UNITS
V_{IN}		-0.3	16	V
ON/OFF, PWGOOD		-0.3	6.3	V
TRIM		Do not apply voltage		
V_{OUT}	MYMGK1R806FRSR	0.6	5.5	V
	MYMGK00506ERSR	0.7	5.5	V
Output Current (I_{OUT})		0	6	A
Storage Temperature (T_{stg})		-40	125	degC
Soldering / Reflow Temperature ⁽³⁾		-	250	degC
Maximum Number of Reflows Allowed		-	1	
ESD Tolerance, HBM		-	±1000	V
Notes:				
(1) The application of any stress beyond those listed under "Absolute Maximum Ratings" may cause permanent damage to the device, and exposure at any of these ratings for extended periods may reduce the reliability of the device. The above "Absolute Maximum Ratings" are stress ratings only; the notation of these conditions does not imply functional operation of the device at these or any other conditions that fall outside of the range identified by the operational sections of this specification.				
(2) All Voltage are with respect to GND plane.				
(3) Recommended Reflow profile is written in "Soldering Guidelines".				
(4) Human body model, per the JEDEC standard JS-001-2012.				

Recommended Operating Conditions ⁽¹⁾

Table 7. Recommended Operating Conditions

PARAMETER		MIN	MAX	UNITS
Input Voltage (V_{IN})	MYMGK1R806FRSR	4.5	15	V
	MYMGK00506ERSR	8	15	V
Ambient Temperature (T_A) ⁽²⁾		-40	85	degC
Junction Temperature (T_J) ⁽²⁾		-40	120	degC
Output Current (I_{OUT})		0	6	A
Notes:				
(1) Device should not be operated outside the operating conditions. The reliability is tested at the maximum voltage of the recommended operating condition. Above of recommended operation may reduce reliability of the device.				
(2) See the temperature derating curves in the thermal deratings. However, do not condensate.				

Package Thermal Characteristics

Table 8. Package Thermal Characteristics

PARAMETER	CONDITIONS	TYP	UNITS
Thermal Resistance(Reference data) ψ_{j-c}	$V_{IN} = 12V, V_{OUT} = 5V, I_{OUT} = 6A$	5	degC/W
	$V_{IN} = 12V, V_{OUT} = 5V, I_{OUT} = 3A$	7.5	degC/W
	$V_{IN} = 5V, V_{OUT} = 1.8V, I_{OUT} = 6A$	6	degC/W
	$V_{IN} = 5V, V_{OUT} = 1.8V, I_{OUT} = 3A$	9	degC/W
Notes:			
(1) The thermal resistance is only reference data, and it is measured with our evaluation board as below. 50.8mm x 60.0mm x 1.6mm (4 Layers, 1oz copper each) FR-4.			

Electrical Characteristics⁽¹⁾

Electrical Characteristics Table

MYMGK1R806FRSR: $V_{IN} = 5V$, $I_{OUT} = 6A$, $T_A = 25\text{degC}$, unless otherwise noted
 MYMGK00506ERSR: $V_{IN} = 12V$, $I_{OUT} = 6A$, $T_A = 25\text{degC}$, unless otherwise noted

Table 9. Electric Characteristics Table

PARAMETER	SYMBOL	CONDITIONS		MIN	TYP	MAX	UNITS
INPUT SUPPLY							
Input Voltage	V_{IN}	MYMGK1R806FRSR		4.5	12	15	V
		MYMGK00506ERSR		8	12	15	V
V_{IN} Under Voltage Lockout Threshold, V_{IN} Rising	V_{IN_UVH}	$I_{OUT} = 0A$	MYMGK1R806FRSR	-	4.3	-	V
			MYMGK00506ERSR	-	6.0	-	V
V_{IN} Under Voltage Lockout Threshold, V_{IN} Falling ⁽¹¹⁾	V_{IN_UVL}	$I_{OUT} = 0A$	MYMGK1R806FRSR	-	4.1	-	V
			MYMGK00506ERSR	-	5.5	-	V
V_{IN} Current Supply, Full load	I_{IN_FULL}	$V_{IN} = 12V$, $V_{OUT} = 5V$, $I_{OUT} = 6A$		-	2.6	-	A
V_{IN} Current Supply, Switching	I_{IN_SW}	$V_{IN} = 12V$, $I_{OUT} = 0A$		-	24	-	mA
V_{IN} Current Supply, Shutdown	I_{IN_SD}	$V_{IN} = 5V$ or $12V$, $EN = 0V$		-	1	-	mA
ENABLE INPUT (ON/OFF PIN)⁽⁴⁾							
Threshold High	V_{TH_ENH}	$7.8V \leq V_{IN}$		1.5	-	6.3	V
		$V_{IN} < 7.8V$				$V_{IN} \cdot 1.5$	
					OPEN		
Threshold Low	V_{TH_ENL}			-0.3	-	1.1	V
ON/OFF Pin Input Current	I_{EN}	see Figure 62					
CONVERTER							
Efficiency	EFF	$V_{IN} = 5.0V$, $V_{OUT} = 1.8V$, $I_{OUT} = 6A$		-	90.4	-	%
		MYMGK1R806FRSR					
		$V_{IN} = 5.0V$, $V_{OUT} = 1.0V$, $I_{OUT} = 6A$		-	84.7	-	%
		MYMGK00506ERSR		-	95.4	-	%
Fixed Switching Frequency	F_{SW}	MYMGK1R806FRSR		-	250	-	kHz
		MYMGK00506ERSR		-	300	-	kHz
Start-up Time (V_{in} ON)	T_{START_UP}	5% to 90% of V_{OUT}		-	4	-	ms
Start-up Time (Enable ON)		5% to 90% of V_{OUT}		-	4	-	ms
POWER GOOD (PWGOOD PIN)							
PGOOD Sink Current	I_{S_PG}	$V_{PWGOOD} = 0.5V$		-	6	-	mA
PGOOD TRUE (HI)	V_{TH_PGH}	V_{OSET} means set voltage.		$V_{OSET} \times 96\%$		$V_{OSET} \times 113\%$	V
PGOOD FALSE (LO)	V_{TH_PGL}			Out of above range			V
OUTPUT							
Output Current ⁽²⁾	I_{OUT}			0	-	6	A
Output Voltage ⁽⁹⁾	V_{OUT}	MYMGK1R806FRSR		0.6	-	5.0	V
		MYMGK00506ERSR		0.7	-	5.0	V
Total Output Voltage Accuracy ⁽⁷⁾	V_{OUT_ACC}	Fixed input voltage		-3.0	-	+3.0	%
Line Regulation ⁽¹⁴⁾	V_{OUT_LINE}	$V_{IN} = \text{min. to max.}$		-	± 1.0	-	%
Load Regulation ⁽¹⁴⁾	V_{OUT_LOAD}	$I_{OUT} = \text{min. to max.}$		-	± 1.0	-	%
Temperature Variation ⁽¹⁴⁾	V_{OUT_TEMP}	$-40 \leq T_A \leq 85\text{degC}$		-	± 1.0	-	%

PARAMETER	SYMBOL	CONDITIONS	MIN	TYP	MAX	UNITS
Dynamic Load Peak Deviation	V _{OUT_DYN}	V _{IN} = 12 V, V _{OUT} = 5V, I _{OUT} = 50 to 100%, SR = 2.5A/us	-	±3.0	-	%
Ripple and Noise (20MHz bandwidth) ⁽⁶⁾	V _{RIP}		-	1	-	% of V _{OUT}
External Output Capacitance Range ⁽¹⁰⁾	C _{OUT}		400	-	3000	uF
PROTECTION						
Over Current Protection Threshold	I _{OCPTH}	HICCUP operating ⁽⁵⁾	-	9	-	A
Over Voltage Protection ⁽¹²⁾	V _{OCPTH}		>120			% of V _{OUT}
Under Voltage Protection	V _{UVPTH}		< 68			% of V _{OUT}
Thermal Protection ⁽⁸⁾⁽¹³⁾	T _{OTPTH}	Shutdown operating	-	145	-	degC
Thermal Protection Hysteresis ⁽⁸⁾⁽¹³⁾	T _{OTPHYS}		-	40	-	degC
Pre-bias Start-up			Converter will start up if the external output voltage is less than set V _{OUT} .			
ENVIRONMENTAL						
Moisture Sensitivity Level			3			
Calculated MTBF ⁽³⁾		T _A = 40degC, V _{IN} = 5.0V, V _{OUT} = 1.8V, I _{OUT} = 50%	-	8.40x 10 ⁶	-	hours

Notes

- (1) Specifications are typical at 25degC, V_{IN} = typical +12V, V_{OUT} = typical +5V, full load, external capacitors and natural convection unless otherwise indicated.
All models are tested and specified with external 220uF x 2 or 100uF x 4 ceramic output capacitors and 22uF x 2 ceramic and plenty of electrolytic external input capacitors. All capacitors are low ESR types. These capacitors are necessary to accommodate our test equipment and may not be required to achieve specified performance in your applications. However, Murata recommends installation of these capacitors.
- (2) Note that Maximum Power Derating curves indicate an average current at typical input voltage. At higher temperatures and/or no airflow, the converter will tolerate brief full current outputs if the total RMS current over time does not exceed the Derating curve.
- (3) Mean Time Between Failure is calculated using the Telcordia SR-332 method, 40degC, half output load, natural air convection.
- (4) The ON/OFF Control Input should use either a switch or an open collector/open drain transistor referenced to GND. A logic gate may also be used by applying appropriate external voltages which do not exceed absolute maximum ratings.
- (5) "Hiccup" overcurrent operation repeatedly attempts to restart the converter with a brief, full-current output. If the overcurrent condition still exists, the restart current will be removed and then tried again. This short current pulse prevents overheating and damaging the converter. Once the fault is removed, the converter immediately recovers normal operation.
- (6) Output noise may be further reduced by adding an external filter. At zero output current, the output may contain low frequency components which exceed the ripple specification. The output may be operated indefinitely with no load.
- (7) Regulation specifications describe the deviation as the line input voltage or output load current is varied from a midpoint value to either extreme.
- (8) Thermal Protection/Shutdown temperature is measured with the semiconductor in the converter.
- (9) Do not exceed maximum power specifications when adjusting the output trim.
- (10) The maximum output capacitive loads depend on the Equivalent Series Resistance (ESR) of the external output capacitor and, to a lesser extent, the distance and series impedance to the load. Larger caps will reduce output noise but may change the transient response. Newer ceramic caps with very low ESR may require lower capacitor values to avoid instability. Thoroughly test your capacitors in the application.
- (11) Do not allow the input voltage to degrade lower than the input undervoltage shutdown voltage at all times. Otherwise, you risk having the converter turn off. The Under-voltage shutdown is not latching and will attempt to recover when the input is brought back into normal operating range.
- (12) The outputs are intended to sink appreciable reverse current.
- (13) When the temperature decreases below the turn-in threshold, the converter will automatically restart.
- (14) Ensured by design. Not production tested.

Typical Performance Characteristics

In this document, all characteristics are measured with the test board. The schematic and part list of the board are shown in Figure 59 and Table 11. The board is under $T_A = 25\text{degC}$ with no airflow unless otherwise noted.

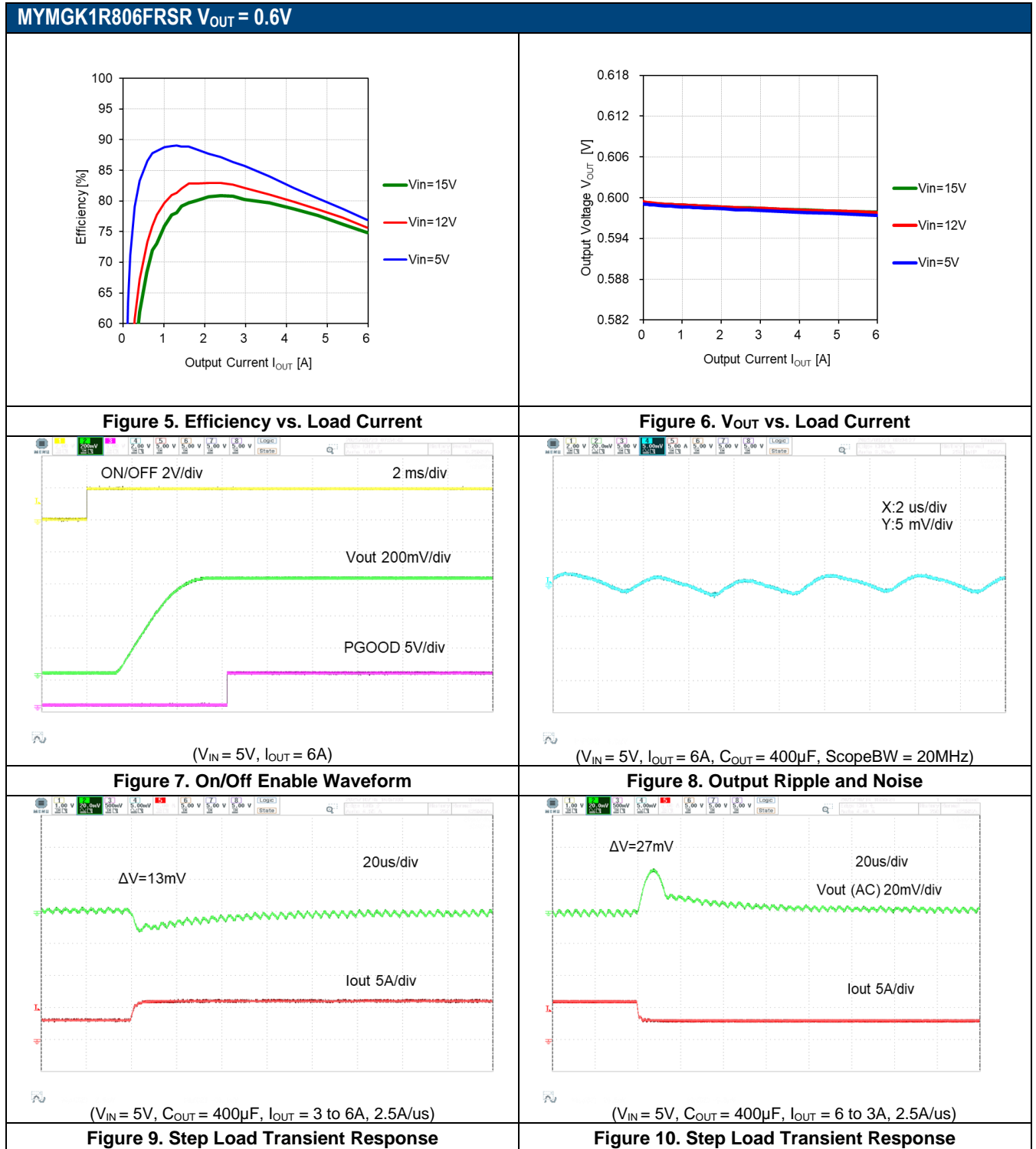

MYMGK1R806FRSR $V_{OUT} = 1.0V$

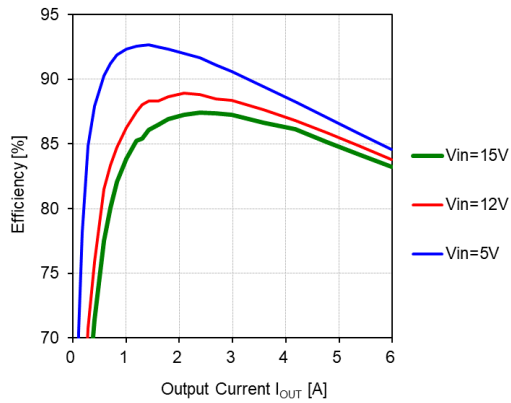

Figure 11. Efficiency vs. Load Current

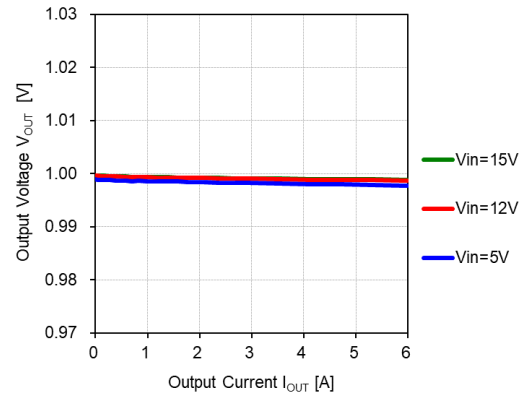

Figure 12. V_{OUT} vs. Load Current

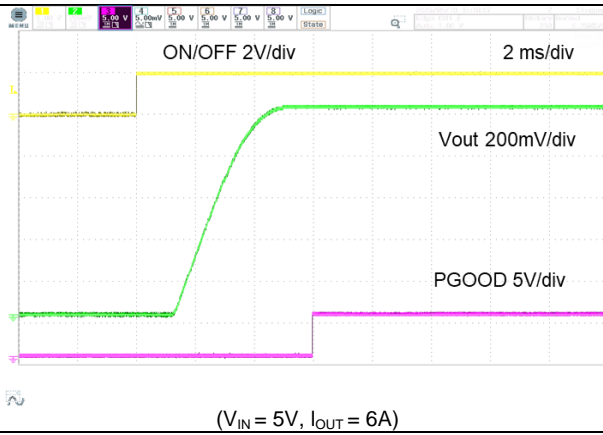

Figure 13. On/Off Enable Waveform

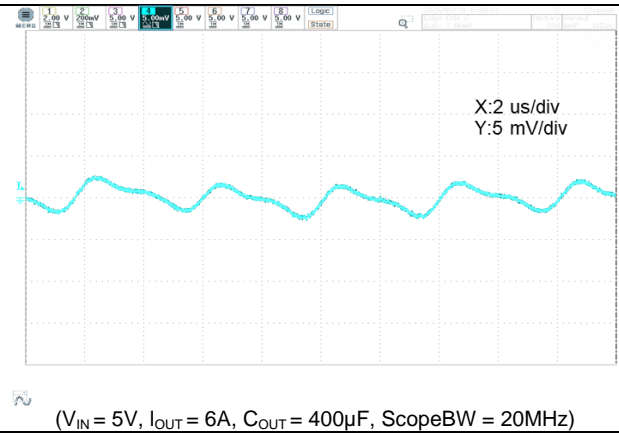

Figure 14. Output Ripple and Noise

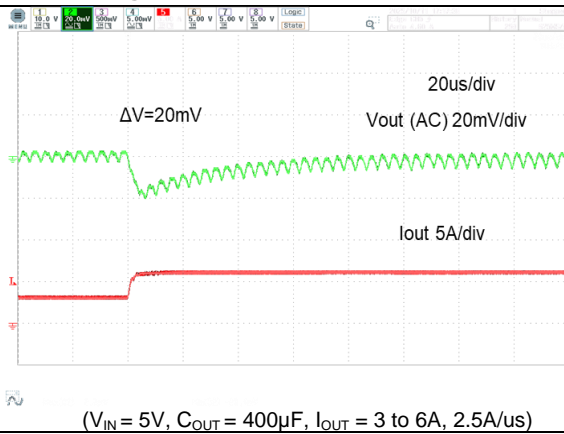

Figure 15. Step Load Transient Response

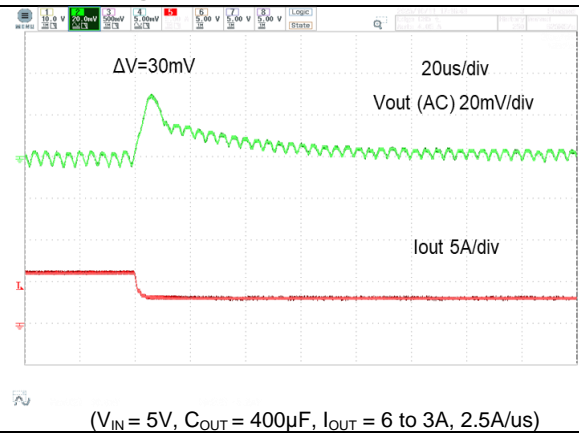

Figure 16. Step Load Transient Response

MYMGK1R806FRSR $V_{OUT} = 1.0V$

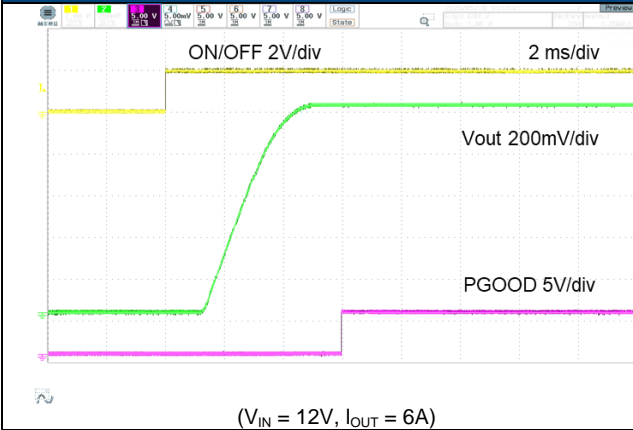

Figure 17. On/Off Enable Waveform

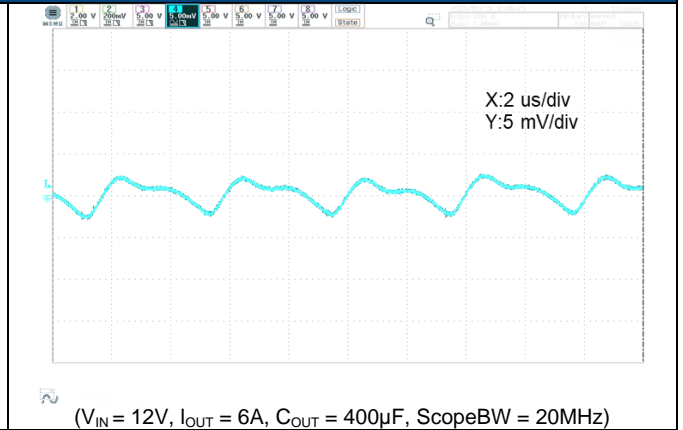

Figure 18. Output Ripple and Noise

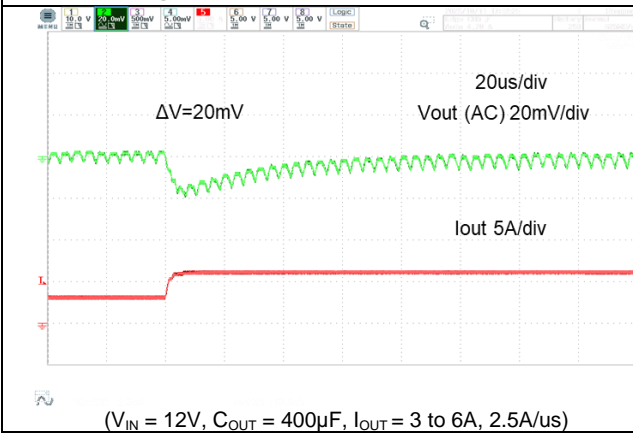

Figure 19. Step Load Transient Response

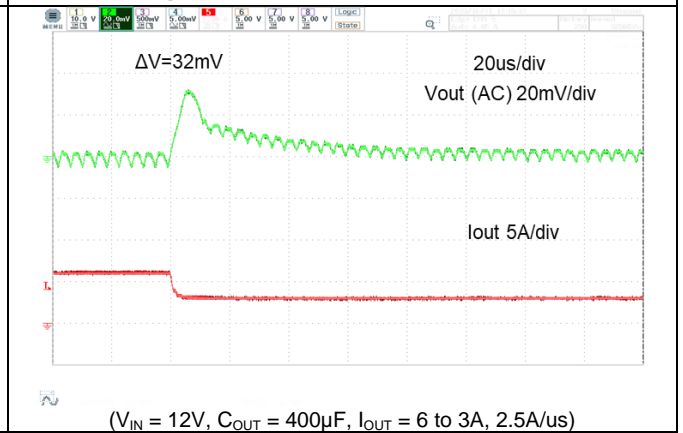

Figure 20. Step Load Transient Response

MYMGK1R806FRSR $V_{OUT} = 2.5V$

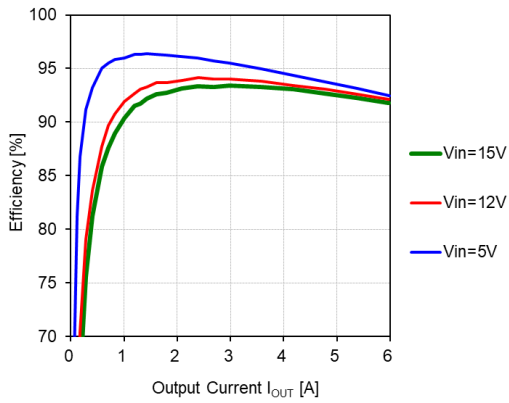

Figure 21. Efficiency vs. Load Current

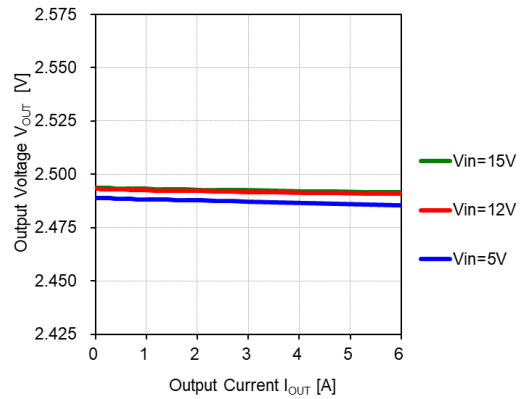
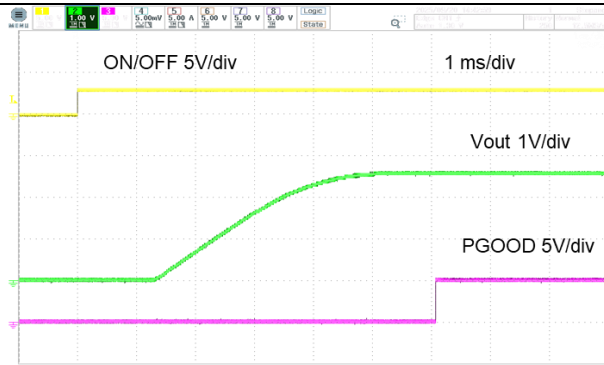
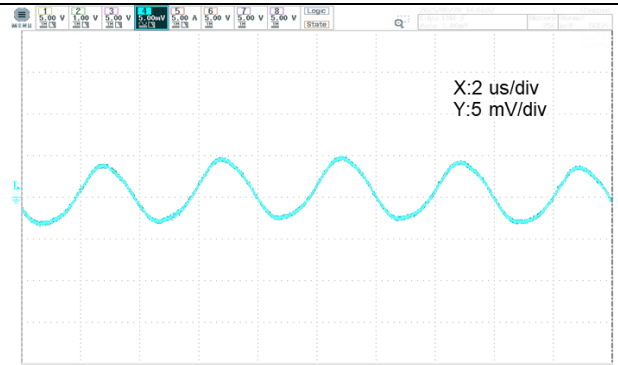

Figure 22. V_{OUT} vs. Load Current



($V_{IN} = 5V, I_{OUT} = 6A$)

Figure 23. On/Off Enable Waveform



($V_{IN} = 5V, I_{OUT} = 6A, C_{OUT} = 400\mu F, \text{ScopeBW} = 20\text{MHz}$)

Figure 24. Output Ripple and Noise

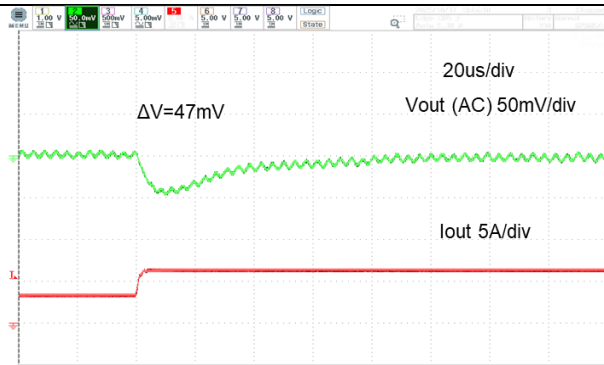

($V_{IN} = 5V, C_{OUT} = 400\mu F, I_{OUT} = 3 \text{ to } 6A, 2.5A/us$)

Figure 25. Step Load Transient Response

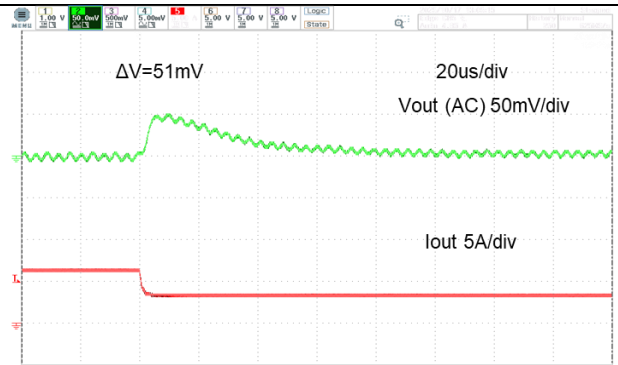

($V_{IN} = 5V, C_{OUT} = 400\mu F, I_{OUT} = 6 \text{ to } 3A, 2.5A/us$)

Figure 26. Step Load Transient Response

MYMGK1R806FRSR $V_{OUT} = 3.3V$

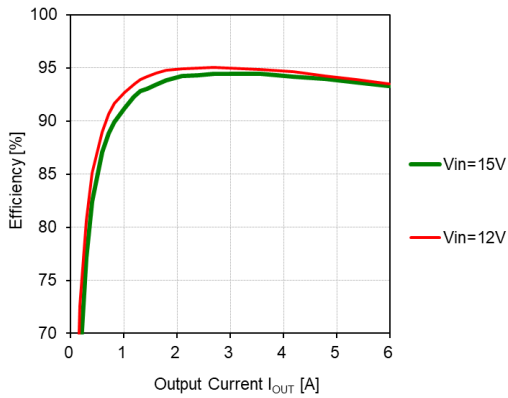

Figure 27. Efficiency vs. Load Current

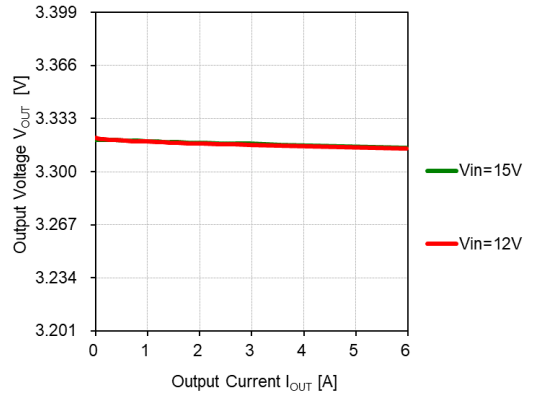
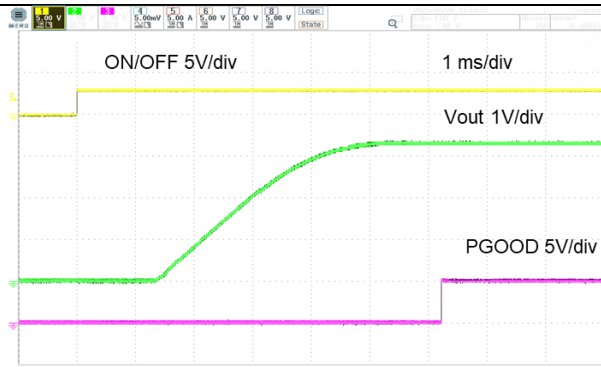
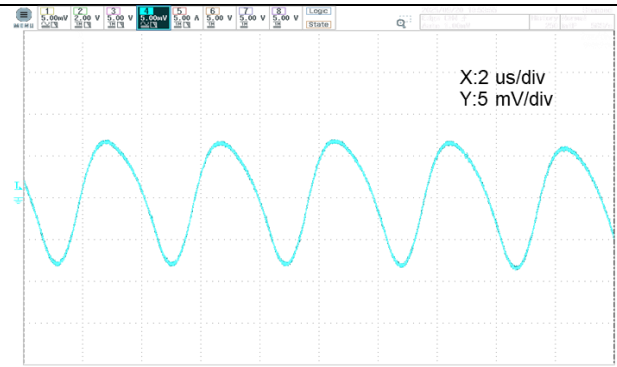

Figure 28. V_{OUT} vs. Load Current



($V_{IN} = 12V, I_{OUT} = 6A$)

Figure 29. On/Off Enable Waveform



($V_{IN} = 12V, I_{OUT} = 6A, C_{OUT} = 400\mu F, \text{ScopeBW} = 20\text{MHz}$)

Figure 30. Output Ripple and Noise

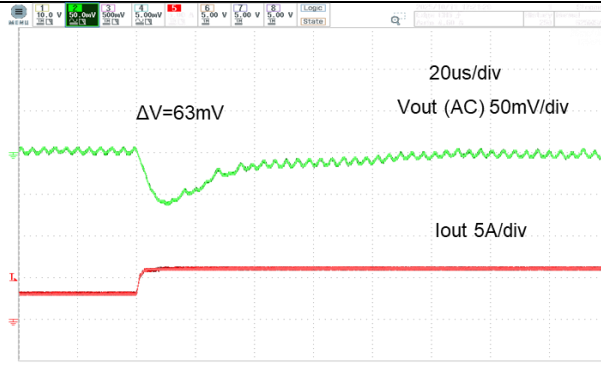

($V_{IN} = 12V, C_{OUT} = 400\mu F, I_{OUT} = 3 \text{ to } 6A, 2.5A/us$)

Figure 31. Step Load Transient Response

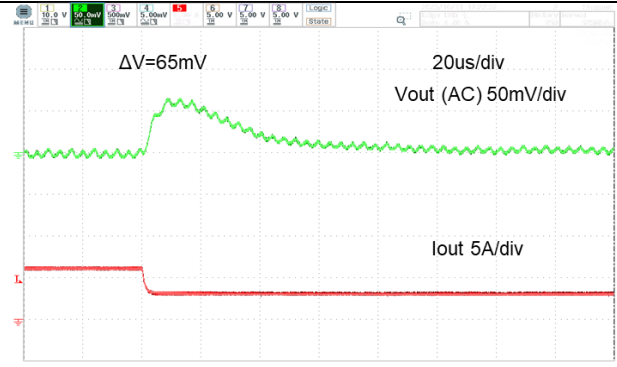

($V_{IN} = 12V, C_{OUT} = 400\mu F, I_{OUT} = 6 \text{ to } 3A, 2.5A/us$)

Figure 32. Step Load Transient Response

MYMGK1R806FRSR $V_{OUT} = 5.0V$

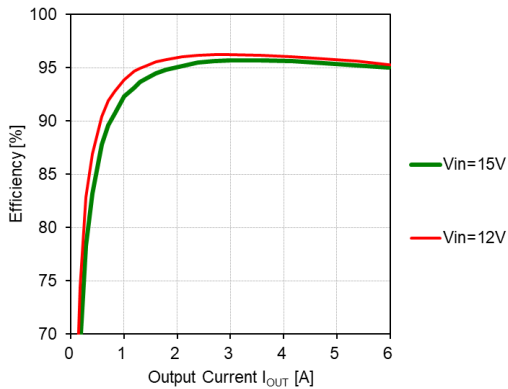

Figure 33. Efficiency vs. Load Current

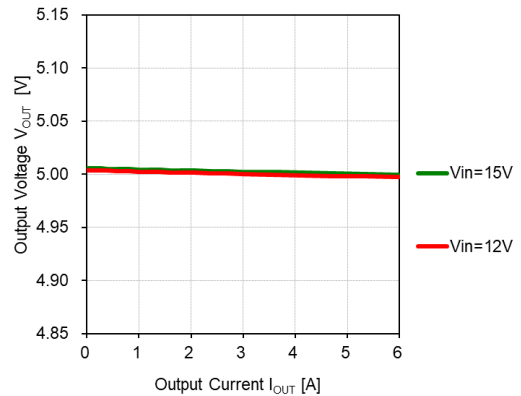
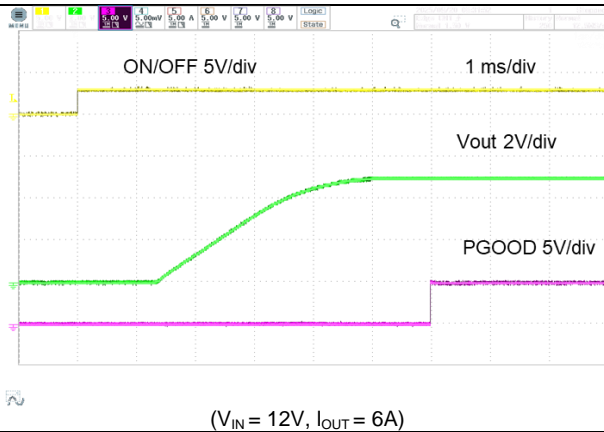
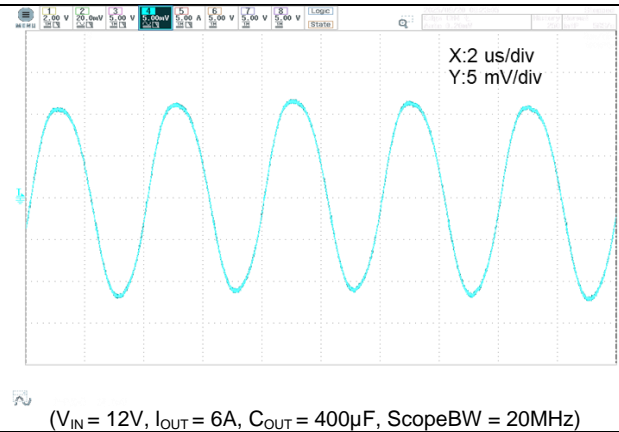

Figure 34. V_{OUT} vs. Load Current



($V_{IN} = 12V, I_{OUT} = 6A$)

Figure 35. On/Off Enable Waveform



($V_{IN} = 12V, I_{OUT} = 6A, C_{OUT} = 400\mu F, \text{ScopeBW} = 20\text{MHz}$)

Figure 36. Output Ripple and Noise

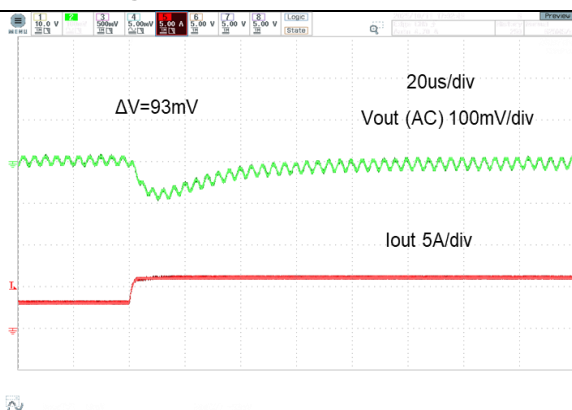

($V_{IN} = 12V, C_{OUT} = 400\mu F, I_{OUT} = 3 \text{ to } 6A, 2.5A/us$)

Figure 37. Step Load Transient Response

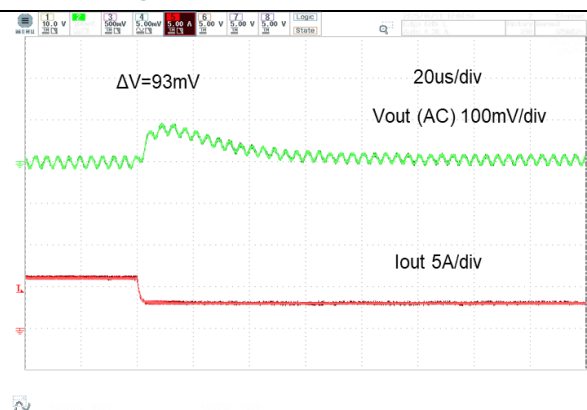

($V_{IN} = 12V, C_{OUT} = 400\mu F, I_{OUT} = 6 \text{ to } 3A, 2.5A/us$)

Figure 38. Step Load Transient Response

MYMGK00506ERSR $V_{OUT} = 1.0V$

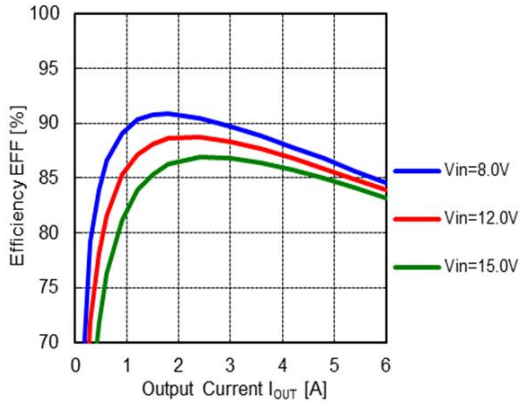

Figure 39. Efficiency vs. Load Current

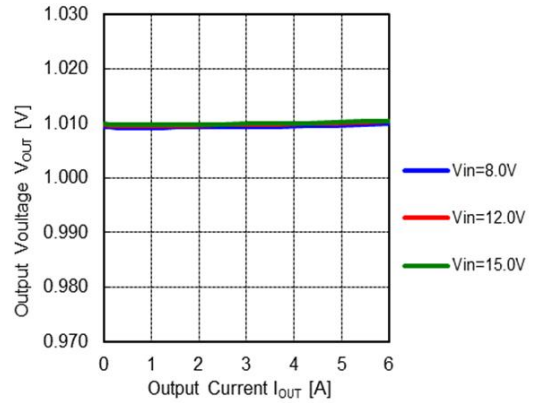

Figure 40. V_{OUT} vs. Load Current

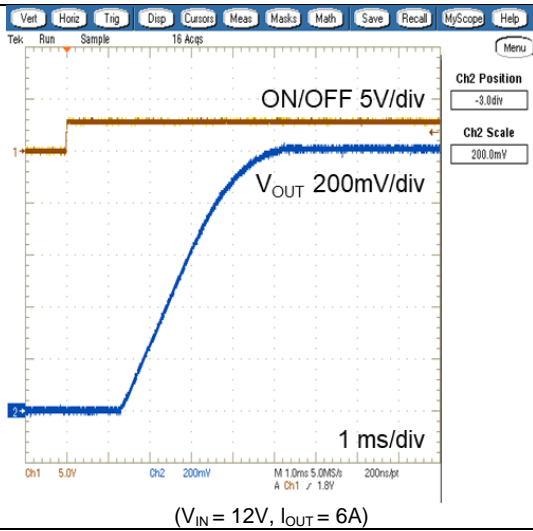

Figure 41. On/Off Enable Waveform

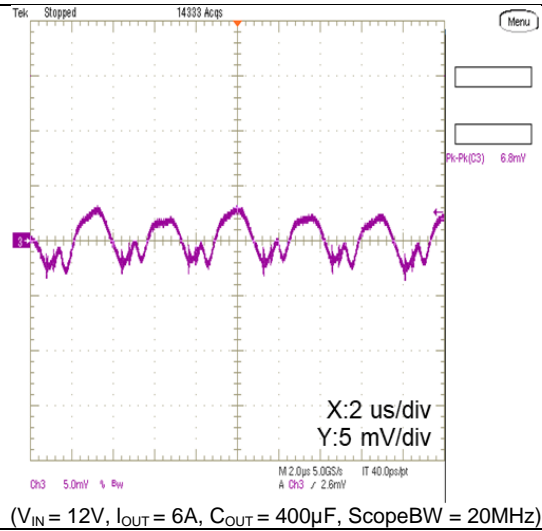

Figure 42. Output Ripple and Noise

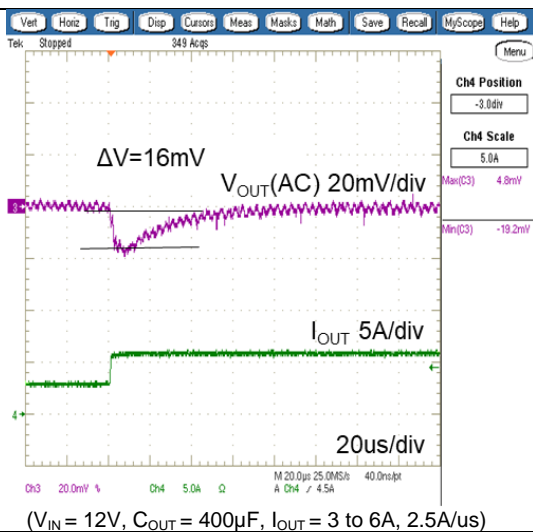

Figure 43. Step Load Transient Response

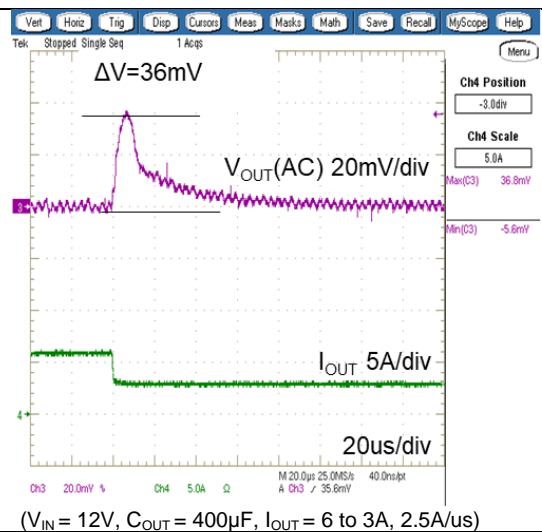

Figure 44. Step Load Transient Response

MYMGK00506ERSR $V_{OUT} = 3.3V$

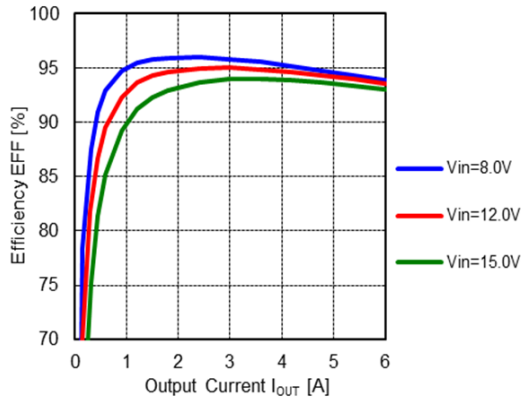

Figure 45. Efficiency vs. Load Current

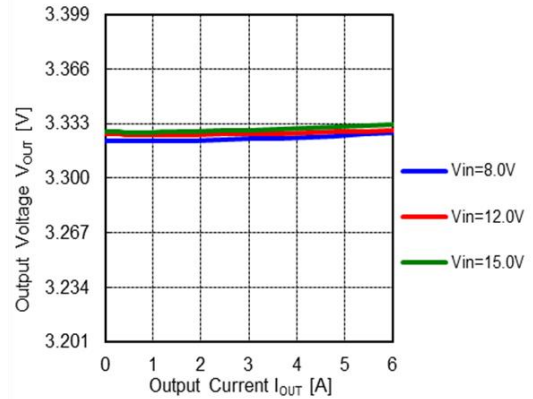

Figure 46. V_{OUT} vs. Load Current

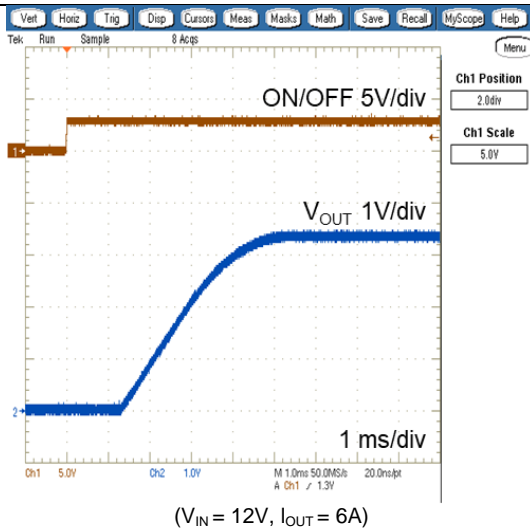

Figure 47. On/Off Enable Waveform

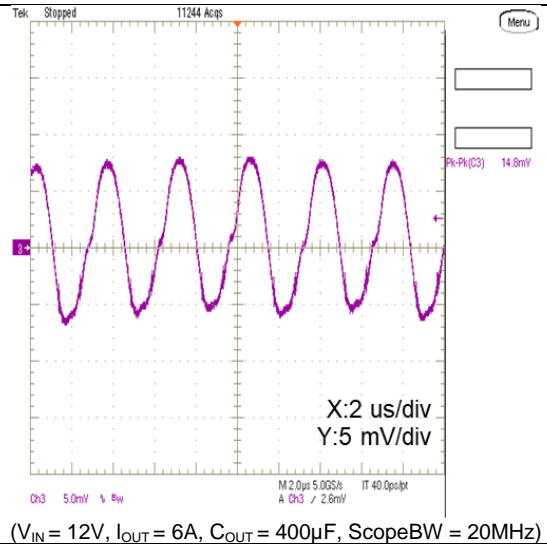

Figure 48. Output Ripple and Noise

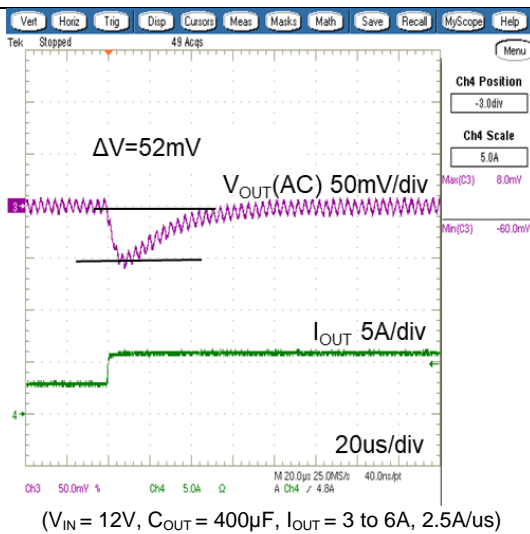

Figure 49. Step Load Transient Response

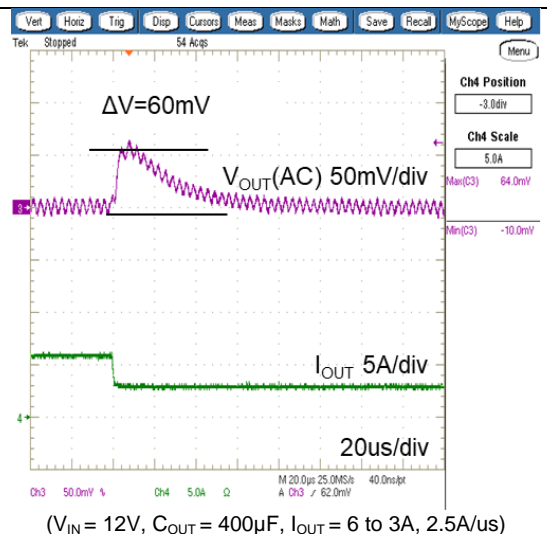

Figure 50. Step Load Transient Response

MYMGK00506ERSR $V_{OUT} = 5.0V$

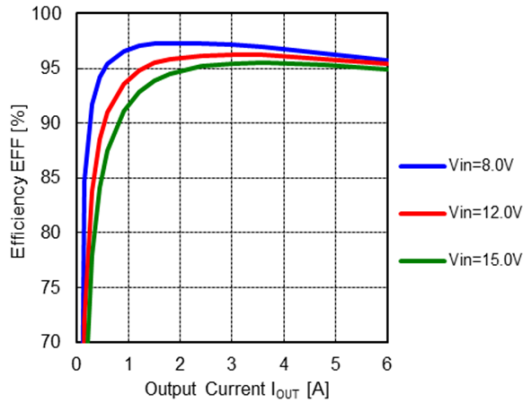

Figure 51. Efficiency vs. Load Current

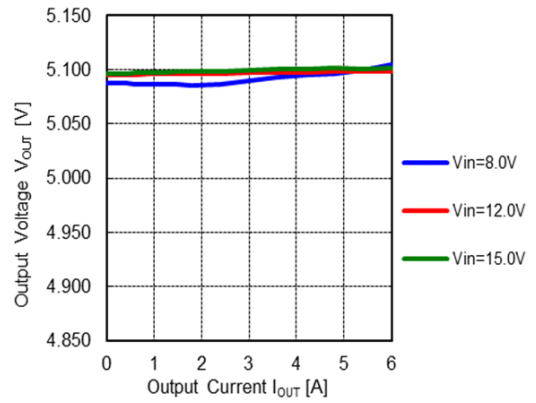

Figure 52. V_{OUT} vs. Load Current

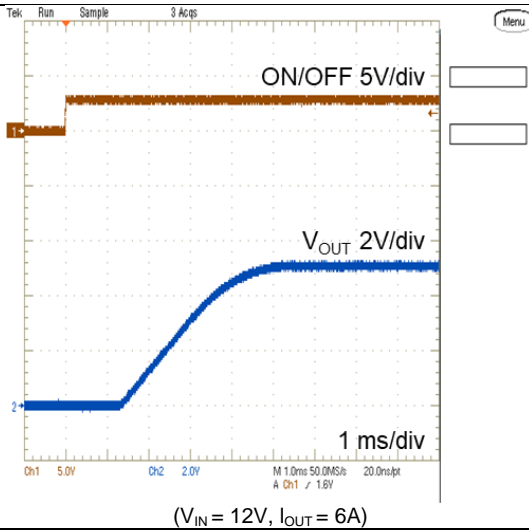

Figure 53. On/Off Enable Waveform

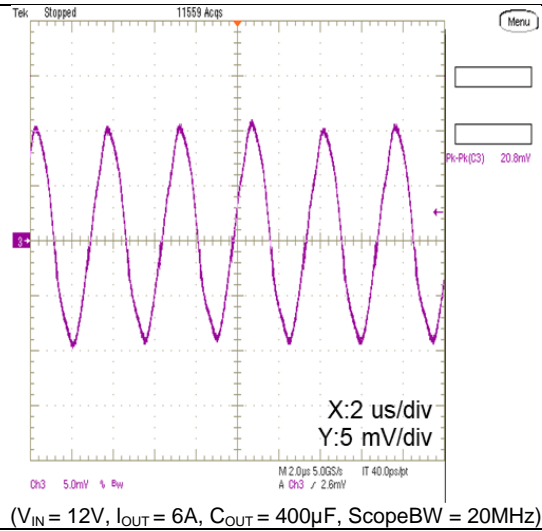

Figure 54. Output Ripple and Noise

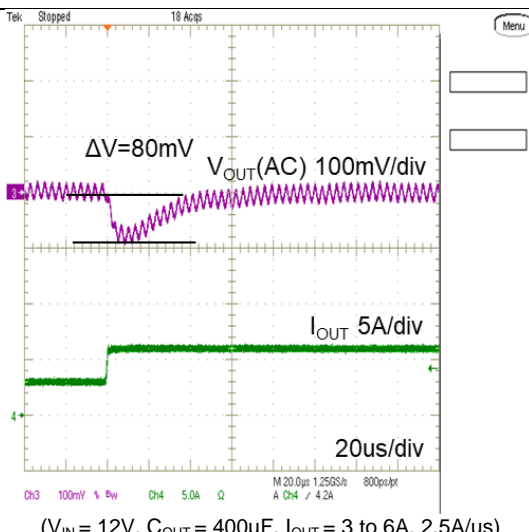

Figure 55. Step Load Transient Response

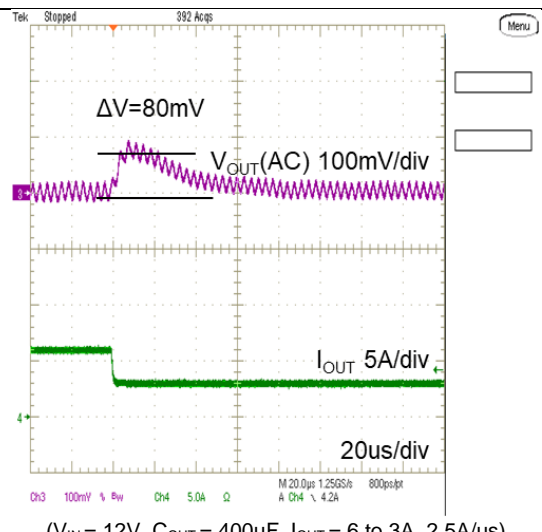

Figure 56. Step Load Transient Response

Thermal Deratings (Reference Data)

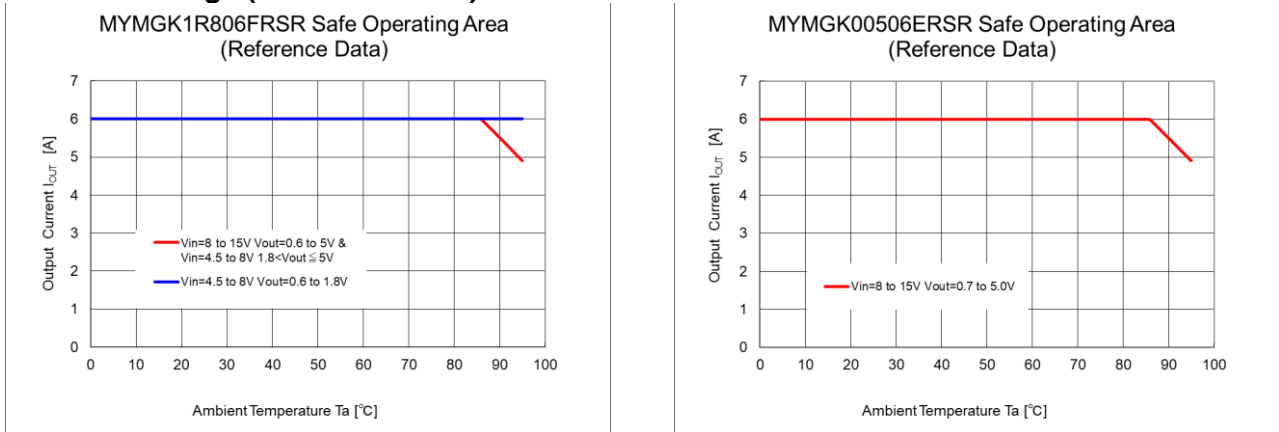
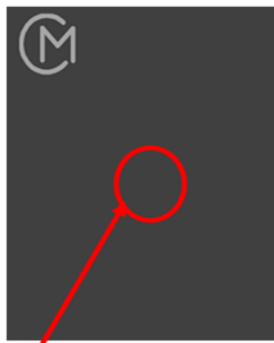

Figure 57. Safe Operating Area



Position: Center of the Module
Radius: 1mm

Figure 58. Temperature Measuring Area

Thermal deratings are evaluated in following condition.

- The product is mounted on 50.8mm x 60.0mm x 1.6mm (4 Layer, 1oz copper each) FR-4 board respectively.
- No forced air flow

Surface temperature of the product: 117degC max.

Transient Response Data

Transient response data at various conditions are showed in following table.

Output capacitance ($C_{OUT1}+C_{OUT2}$) can serve less than 3% x V_{OUT} of deviation for 3A load change (1A/us).

Table 10. Transient Response Data

PART NUMBER	V _{OUT} [V]	V _{IN} [V]	C _{OUT1} [uF]	C _{OUT2} [uF]	VOLTAGE DEVIATION [mV]
					3-6A LOAD STEP (1A/us)
MYMGK1R806FRSR	0.7	5	440	400	21
	1			200	24
	1.8			-	34
MYMGK00506ERSR	1.0	12	400	200	25
	3.3			-	54
	5.0			-	72

Test Circuit

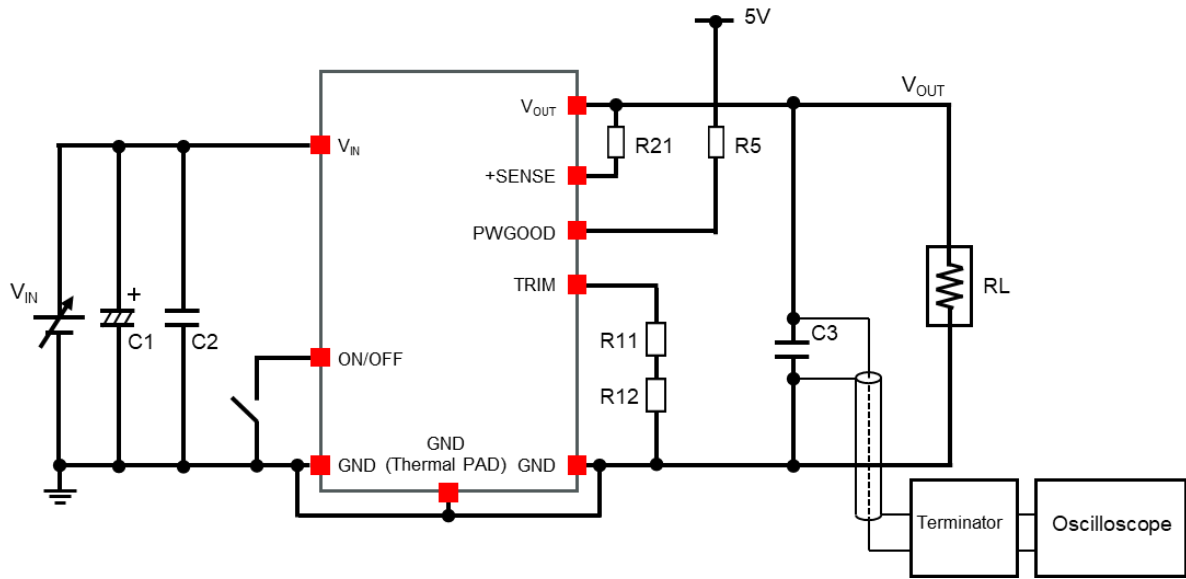

Figure 59. Test Circuit

*1: If there is a non-negligible parasitic impedance between the power supply and the converter, such as during evaluation, the optional input capacitor “C1” may be required to reduce the impedance. The recommended optional capacitor is an example. Please consider the optimum value for the case. This capacitor is usually an aluminum electrolytic type. It isn't necessary to place the capacitor near the input terminal of the converter.

Table 11. Test Circuit Part List

REFERENCE	VALUE	DESCRIPTION	PART AND EQUIPMENT
C2	22uF x 2	Input Capacitor Ceramic capacitor, 22uF, 25V, ±10%, X7R	GRM32ER71E226KE15 (Murata)
C3	$V_{OUT}=0.6$ to 3.0V	Output Capacitor Ceramic capacitor, 220uF, 4V, ±20%, X6S	GRM32EC80G227ME05 (Murata)
	$V_{OUT}=3.0$ to 5.0V	Output Capacitor Ceramic capacitor, 100uF, 6.3V, ±20%, X7U	GRM32EE70J107ME15 (Murata)
R21	0 ohm	Chip resistor	RK73Z1JTDD (KOA)
R11, R12	-	Chip resistor, 1/10W, ±0.5% The value is determined by the target output voltage.	
R5	10 kohm	Chip resistor, 1/10W, ±5.0%	RK73B1JTDD103J (KOA)
C1	1000uF/25V	Electrolytic Capacitor (Optional)	
Oscilloscope	-	Digital Oscilloscope	DPO5034 or TDS5034 (Tektronix)
Terminator	-	Terminator	TRC-50F2 (KEISOKU GIKEN)

Detailed Description

Input Under-Voltage Shutdown and Start-Up Threshold

Under normal start-up conditions, converters will not begin to regulate properly until the ramping-up input voltage exceeds and remains at the Start-Up Threshold Voltage (see Specifications). Once operating, converters will not turn off until the input voltage drops below the Under-Voltage Shutdown Limit. Subsequent restart will not occur until the input voltage rises again above the Start-Up Threshold. This built-in hysteresis prevents any unstable ON/OFF operation at a single input voltage.

Users should be aware however of input sources near the Under-Voltage Shutdown whose voltage decays as input current is consumed (such as capacitor inputs), the converter shuts off and then restarts as the external capacitor recharges. Such situations could oscillate. To prevent this, make sure the operating input voltage is well above the UV Shutdown voltage at all times.

Start-Up Time

Assuming that the output current is set at the rated maximum, the V_{IN} to V_{OUT} Start-Up Time (see Specifications) is the time interval between the point when the ramping input voltage crosses the Start-Up Threshold and the fully loaded regulated output voltage enters and remains within its specified accuracy band. Actual measured times will vary with input source impedance, external input capacitance, input voltage slew rate and final value of the input voltage as it appears at the converter.

This converter includes a soft start circuit to moderate the duty cycle of its PWM controller at power up, thereby limiting the input inrush current.

The ON/OFF Remote Control interval from ON command to V_{OUT} regulated assumes that the converter already has its input voltage stabilized above the Start-Up Threshold before the ON command. The interval is measured from the ON command until the output enters and remains within its specified accuracy band. The specification assumes that the output is fully loaded at maximum rated current. Similar conditions apply to the ON to V_{OUT} regulated specification such as external load capacitance and soft start circuitry.

Output Noise

This converter is tested and specified for output noise using designated external output components, circuits and layout as shown in the figures below. In the figure below, the two copper strips simulate real-world printed circuit impedances between the power supply and its load. In order to minimize circuit errors and standardize tests between units, scope measurements should be made using BNC connectors or the probe ground should not exceed one half inch and soldered directly to the test circuit.

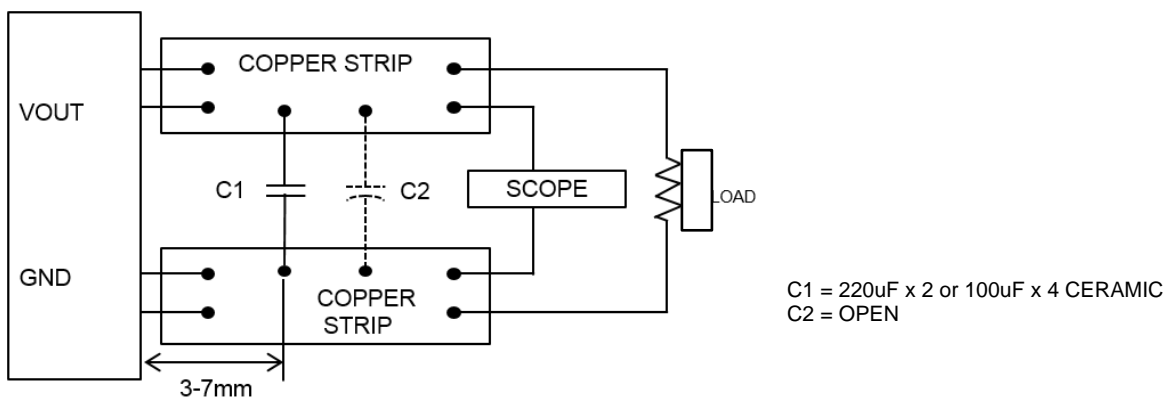

Figure 60. Circuits and Layout

Minimum Output Loading Requirements

The converters regulate within specification and are stable under no load to full load conditions. Operation under no load might slightly increase output ripple and noise.

Thermal Shutdown

To prevent many over temperature problems and damage, the converters include thermal shutdown circuitry. If environmental conditions cause the temperature of the converter to rise above the Operating Temperature Range up to the shutdown temperature, an on-board electronic temperature sensor will shut down the unit. When the temperature decreases below the turn-on threshold, the converter will automatically restart.

CAUTION: If you operate too close to the thermal limits, the converter may shut down suddenly without warning. Be sure to thoroughly test your application to avoid unplanned thermal shutdown.

Temperature Derating Curves

The graph in this data sheet illustrates typical operation under a variety of conditions. The derating curves show the maximum continuous ambient air temperature. Note that these are AVERAGE measurements.

Note that the temperatures are of the ambient airflow, not the converter itself which is obviously running at higher temperature than the outside air. Also note that very low flow rates (below about 25 LFM) are similar to “natural convection,” that is, not using fan-forced airflow. We use both thermocouples and an infrared camera system to observe thermal performance.

CAUTION: This graph is collected at slightly above Sea Level altitude. Be sure to reduce the derating for higher density altitude.

Output Current Limiting

Current limiting inception is defined as the point at which full power falls below the rated tolerance. See the Performance/Functional Specifications. Note particularly that the output current may briefly rise above its rated value in normal operation as long as the average output power is not exceeded. This enhances reliability and continued operation of your application. If the output current is too high, the converter will enter the short circuit condition.

Output Short Circuit Condition

When a converter is in current-limit mode, the output voltage will drop as the output current demand increases.

Following a time-out period, the converter will restart, causing the output voltage to begin ramping up to its appropriate value. If the short-circuit condition persists, another shutdown cycle will initiate. This rapid on/off cycling is called “hiccup mode”. The hiccup cycling reduces the average output current, thereby preventing excessive internal temperatures and/or component damage. A short circuit can be tolerated indefinitely.

The “hiccup” system differs from older latching short circuit systems because you do not have to power down the converter to make it restart. The system will automatically restore operation as soon as the short circuit condition is removed.

Power Good (PWGOOD)

Please refer to the Connection Diagram on page 1 for PWGOOD connection.

The product has a power good (PWGOOD) output. PWGOOD is the open drain of a MOSFET. Connect PWGOOD to another external voltage source or V_{IN} , which are less than 6.3V through a pull-up resistor.

After applying the input voltage, the module turns on so that PWGOOD is pulled to GND before the soft start is ready. After the Trimming voltage reaches the threshold set internally, PWGOOD is pulled high after a delay. When the converter encounters any fault (e.g.: UV, OV, OT, UVLO, etc.), PWGOOD is latched low and cannot be pulled high again until a new soft start is initialized.

The products have power-good output that indicates high when switcher output is within the target. The power-good function is activated after soft-start has finished. If the output voltage becomes within +8% and –8% of the target value, internal comparators detect power-good state and the power-good signal become high after a 1-ms internal delay. If the output voltage goes outside of +16% or –16% of the target value, the power-good signal becomes low after two microsecond (2- μ s) internal delay. The power-good output is an open drain output and must be pulled up internally.

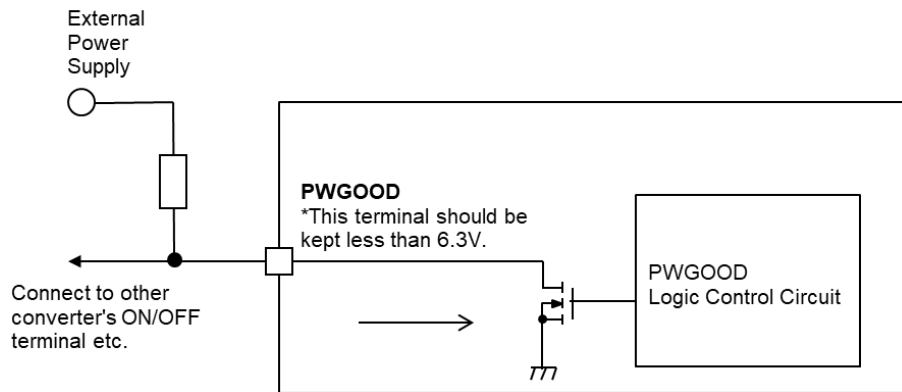

Figure 61. PGOOD Internal Circuit Diagram

UVP/OVP Function

The product monitors a resistor divided feedback voltage to detect over and under voltage. When the feedback voltage becomes lower than 68% of the target voltage, after 1ms, the product turns OFF. The converter restarts after a hiccup delay (about 16ms). This function is enabled 1.5ms after the soft-start is completed. When the feedback voltage becomes higher than 120% of the target voltage, the circuit operates sink-mode to decrease output voltage. If the output voltage reaches UV threshold, the device restarts after a hiccup delay. If the OV condition remains, the converter will not start until the OV condition is removed.

Enable (ON/OFF)

Please refer to the Connection Diagram on page 1 for ON/OFF connections. Positive logic models are enabled when the ON/OFF pin is left open or is pulled high to +Vin with respect to -Vin. An internal bias current causes the open pin to rise to +Vin. Positive-polarity devices are disabled when the ON/OFF is grounded or brought to within a low voltage (see Specifications) with respect to -Vin. Dynamic control of the ON/OFF function should be able to sink appropriate signal current when brought low and withstand appropriate voltage when brought high. Be aware too that there is a finite time in milliseconds (approximately 0.4msec) between the time of ON/OFF Control activation and stable, regulated output. This time will vary slightly with output load type and current and input conditions.

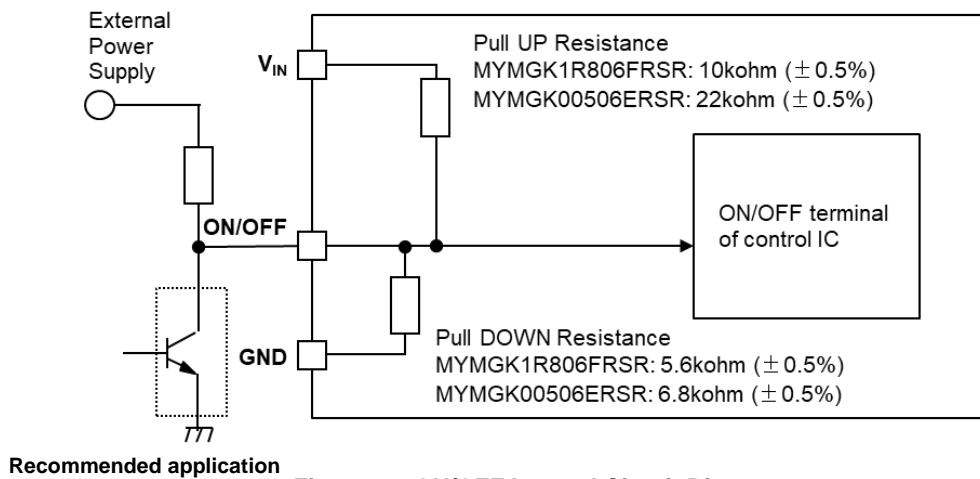

Figure 62. ON/OFF Internal Circuit Diagram

Table 12. ON/OFF Control

OUTPUT	ON/OFF PIN
ON	H
	OPEN
OFF	L

Output Capacitive Load

Users should only consider adding capacitance to reduce switching noise and/or to handle spike current load steps. Install only enough capacitance to achieve noise objectives. Excess external capacitance may cause regulation problems, degraded transient response and possible oscillation or instability.

Output Voltage Adjustment

The output voltage can be adjusted within a specified range by connecting an external TRIM resistor (R_{TRIM}) between the TRIM pin and GND pin. The R_{TRIM} resistor must be a 1/10W precision metal film type, $\pm 0.5\%$ accuracy (or better) with low temperature coefficient, ± 100 ppm/degC or better. Mount the resistor close to the converter with very short leads or use a surface mount trim resistor.

*Determine the R_{TRIM} value using the following formula.

$$R_{TRIM} [\text{kohm}] = 6 / (V_{OUT} - 0.6)$$

Table 13. R_{TRIM} Calculation Example

OUTPUT VOLTAGE [V]	ESTIMATED R_{TRIM} [kohm]	
	MYMGK1R806FRSR	MYMGK00506ERSR
0.6	OPEN	-
0.7	33+27	33+27
1.0	15	15
1.2	10	10
1.5	4.7+2.0	4.7+2.0
1.8	4.7+0.3	4.7+0.3
2.5	3.0+0.16	3.0+0.16
3.3	2.2+0.022	2.2+0.022
5	1.2+0.16	1.2+0.16

CAUTION

Do not exceed the specified limits of the output voltage or the converter's maximum power rating when applying these resistors.

Please observe the limits below for voltage input and output ranges. These limits apply at all output currents ($T_a = 25\text{degC}$).

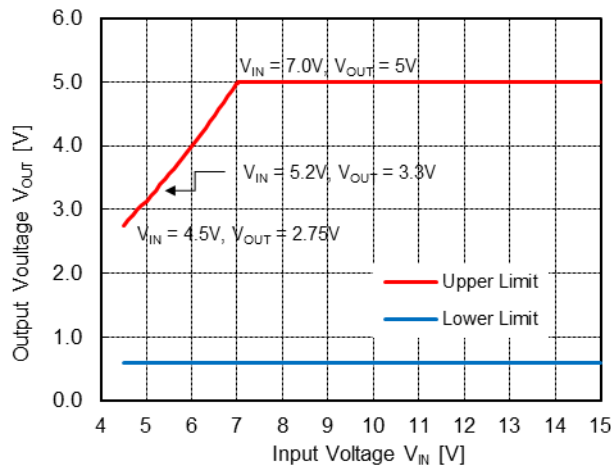

Figure 63. Output Voltage Range

Output Voltage Remote Sense

The function is capable to compensate up the voltage drop between the output and input of load. The sense range depends on the maximum voltage allowing on the V_{OUT} pin. The sense trace should be short as possible and shielded by GND line or else to reduce noise susceptibility. The sense line length is recommended within 10cm for output voltage stability. If the remote sense is not needed, SENSE pin should be connected to V_{OUT} pin.

Application Information

Application Circuit & Part List

An Example of the standard components are shown in Table 14 and Table 15. Components must be chosen referring the system requirement like Voltage, Temperature, etc.

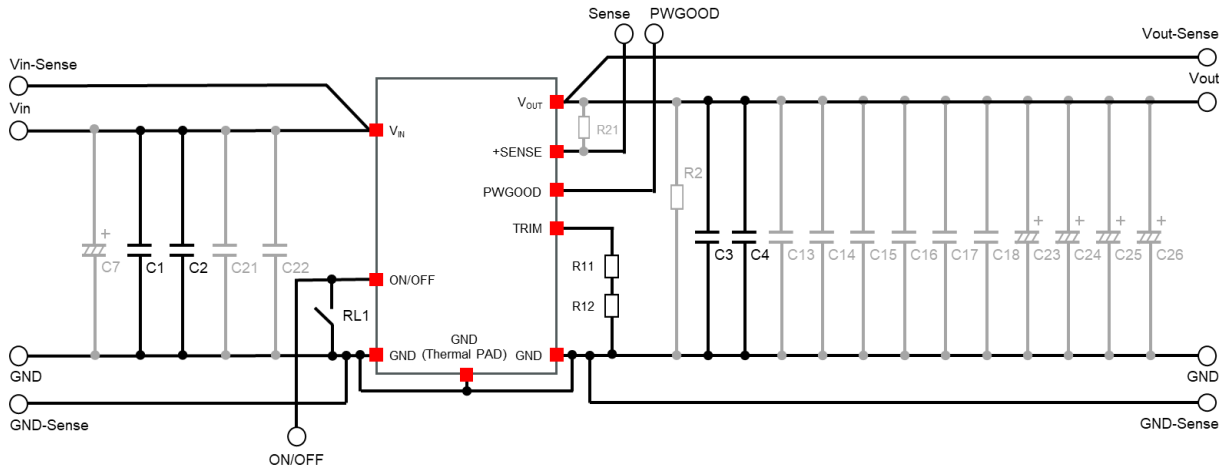

Figure 64. Application Circuit ($V_{OUT} < 3V$)

Table 14. Application Circuit Part List ($V_{OUT} < 3V$)

REFERENCE	VALUE	DESCRIPTION	PART AND EQUIPMENT
C1, C2	22uF	Input Capacitor Ceramic capacitor, 22uF, 25V, ±10%, X7R	GRM32ER71E226KE15 (Murata)
C3, C4	220uF	Output Capacitor Ceramic capacitor, 220uF, 4V, ±20%, X7U	GRM32EC80G227ME05 (Murata)
R11, R12	-	Chip resistor, 1/10W, ±0.5% The value is determined by the target output voltage.	
RL1		Switch	2UD1-T1-A1-M2-R-E (marutsu)
C7, C13, C14, C15, C16, C21, C22, C23, C24, C25, C26, R2, R21		OPEN	

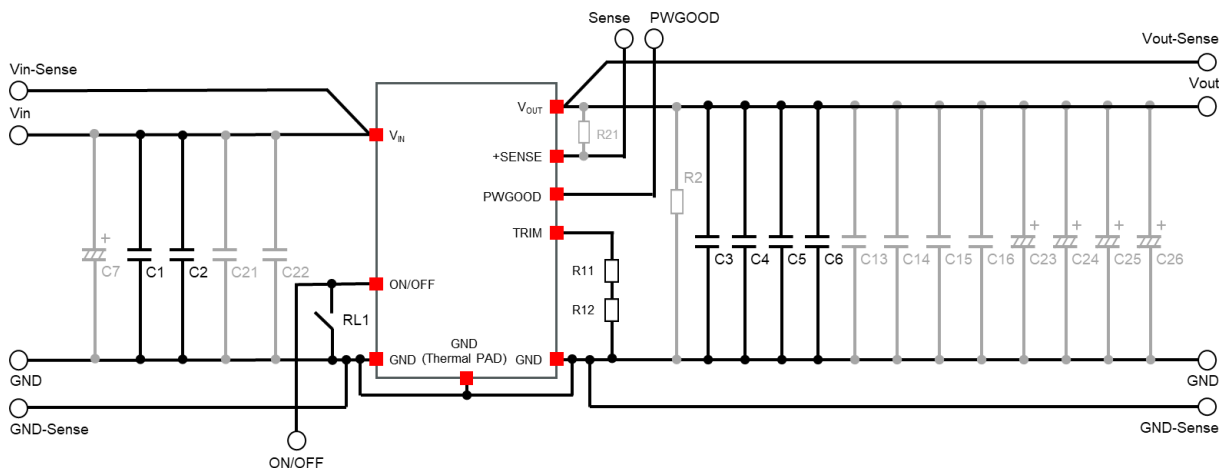

Figure 65. Application Circuit ($3V \leq V_{OUT}$)

Table 15. Application Circuit Part List ($V_{OUT} < 3V$)

REFERENCE	VALUE	DESCRIPTION	PART AND EQUIPMENT
C1, C2	22uF	Input Capacitor Ceramic capacitor, 22uF, 25V, ±10%, X7R	GRM32ER71E226KE15 (Murata)
C3, C4, C5, C6	100uF	Output Capacitor Ceramic capacitor, 100uF, 4V, ±20%, X7U	GRM32EE70J107ME15 (Murata)
R11, R12	-	Chip resistor, 1/10W, ±0.5% The value is determined by the target output voltage.	
RL1		Switch	2UD1-T1-A1-M2-R-E (marutsu)
C7, C13, C14, C15, C16, C21, C22, C23, C24, C25, C26, R2, R21		OPEN	

Example of Pattern Layout (Top View)

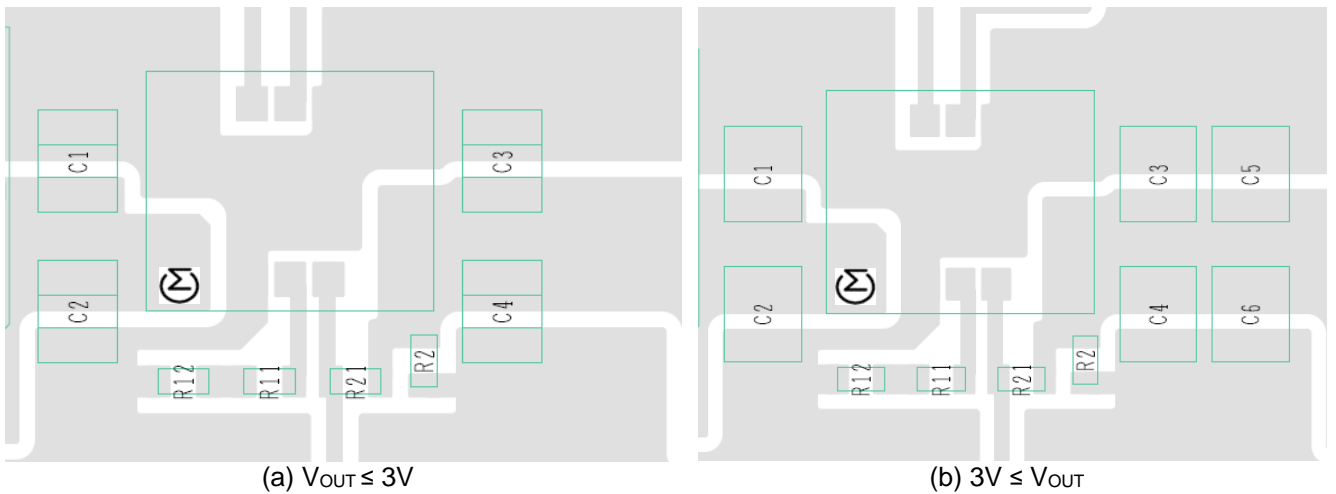

Figure 66. Example of Pattern Layout (Top View)

Application Board Example

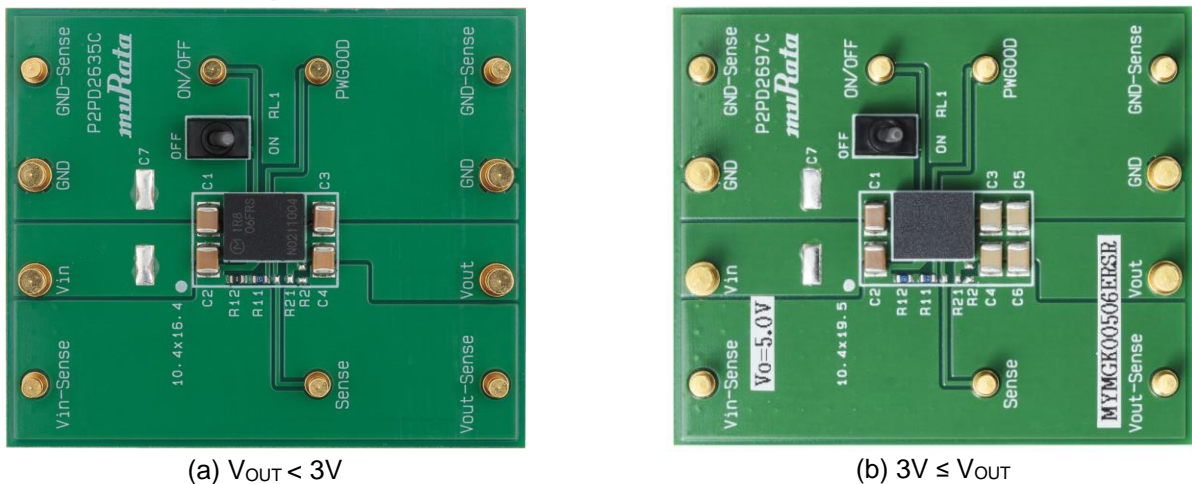

Figure 67. Application Board Example

Component Selection

Input Fuse

Certain applications and/or safety agencies may require fuses at the inputs of power conversion components. Fuses should also be used when there is the possibility of sustained input voltage reversal which is not current limited. For greatest safety, we recommend a fast blow fuse installed in the ungrounded input supply line. The installer must observe all relevant safety standards and regulations. For safety agency approvals, install the converter in compliance with the end-user safety standard.

Recommended Input Filtering

The user must assure that the input source has low AC impedance to provide dynamic stability and that the input supply has little or no inductive content, including long distributed wiring to a remote power supply. For best performance, we recommend installing a low-ESR capacitor immediately adjacent to the converter's input terminals.

The capacitor should be a ceramic type such as the Murata GRM32 series and a electrolytic type such as Panasonic OS-CON series. Initial suggested capacitor values are 22uF x 2 and 1000uF x 1 electrolytic type, rated at twice the expected maximum input voltage. Make sure that the input terminals do not go below the undervoltage shutdown voltage at all times. More input bulk capacitance may be added in parallel (either electrolytic or tantalum) if needed.

Recommended Output Filtering

The converter will achieve its rated output ripple and noise with additional external capacitor. The user may install more external output capacitance reduce the ripple even further or for improved dynamic response. Again, use low-ESR ceramic (Murata GRM32 series). Initial values of 220uF x 2 or 100uF x 4 ceramic type may be tried, either single or multiple capacitors in parallel. Mount these close to the converter. Measure the output ripple under your load conditions.

Use only as much capacitance as required to achieve your ripple and noise objectives. Excessive capacitance can make step load recovery sluggish or possibly introduce instability. Do not exceed the maximum rated output capacitance listed in the specifications.

Recommended Board Land Pattern (Top View)

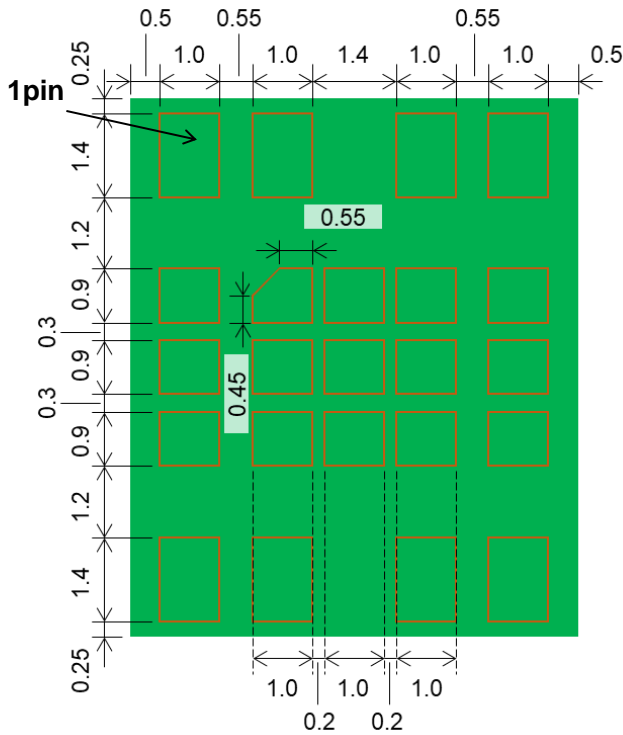

(a) Board Land Pattern

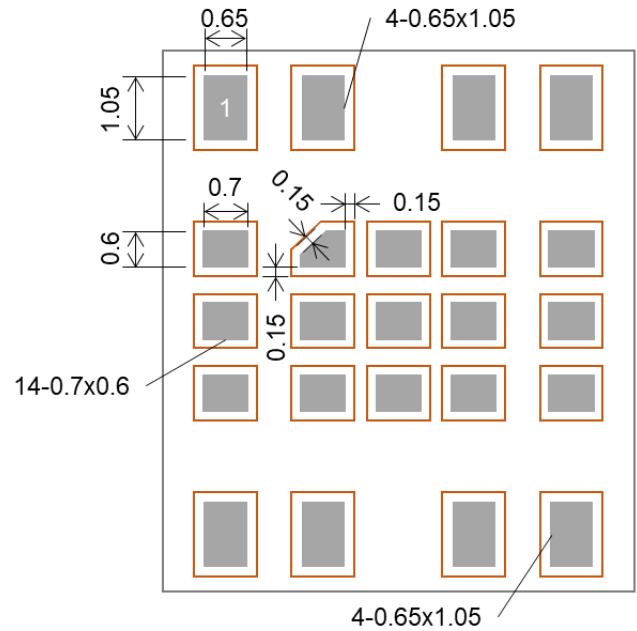

Solder thickness: 120µm (Ref.)
(b) Metal Mask Design

Figure 69. Recommended Board Pattern (Top View)

Tape and Reel Information

Tape Dimensions

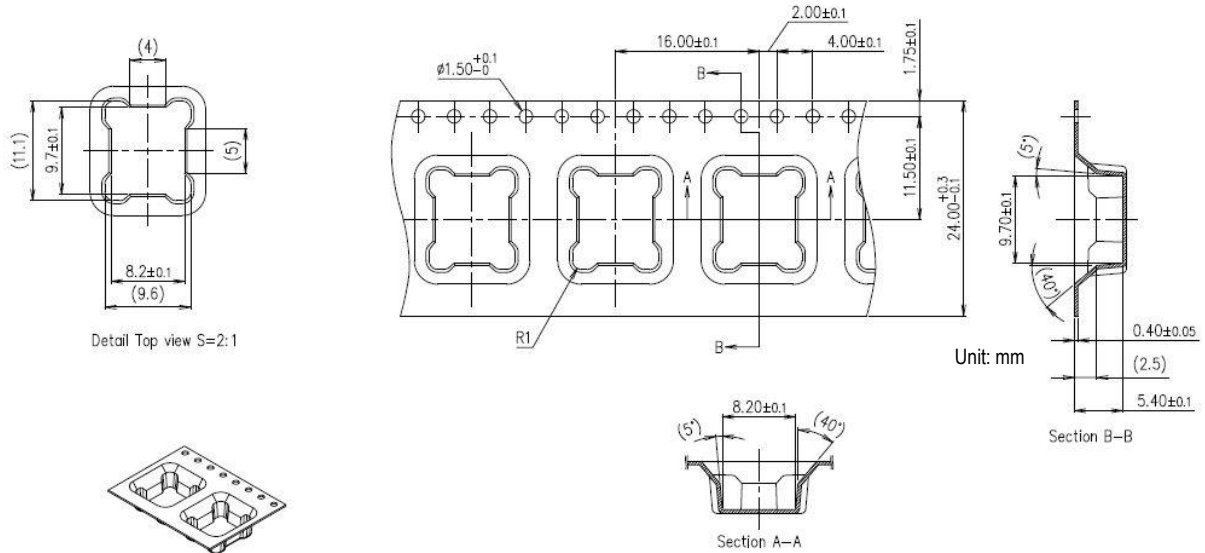

Figure 70. Tape Dimension

Reel Dimensions

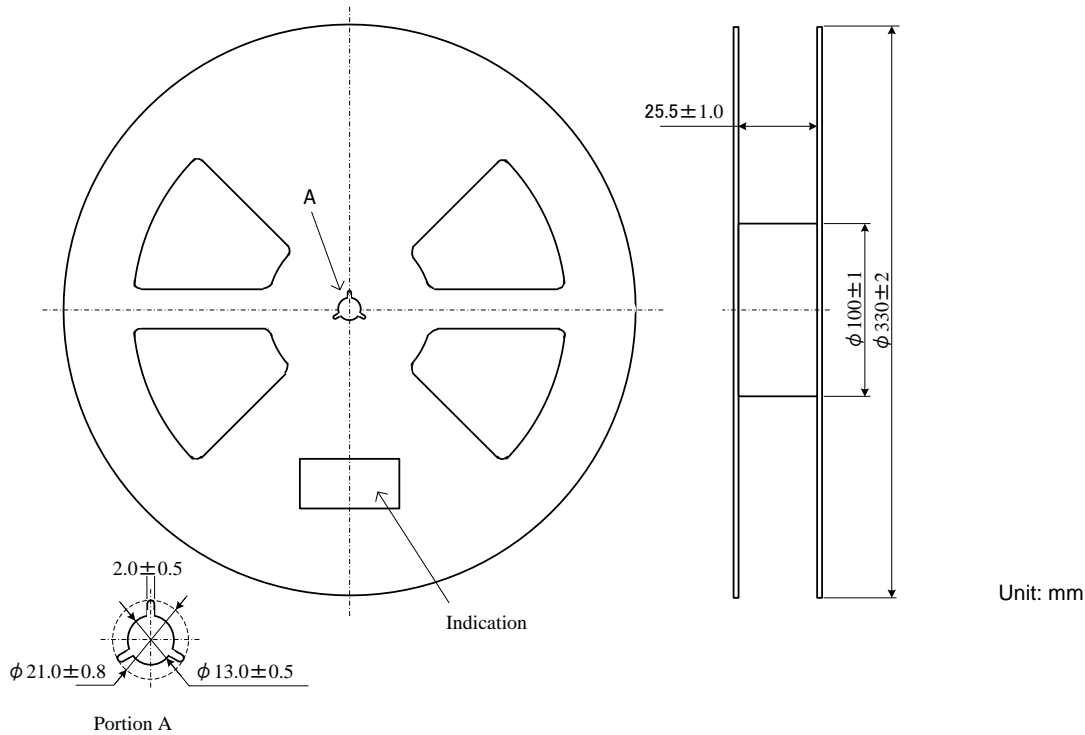

Figure 71. Reel Dimension

Tape Specifications

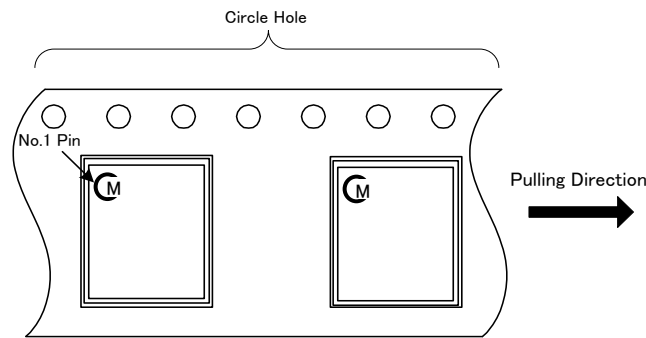
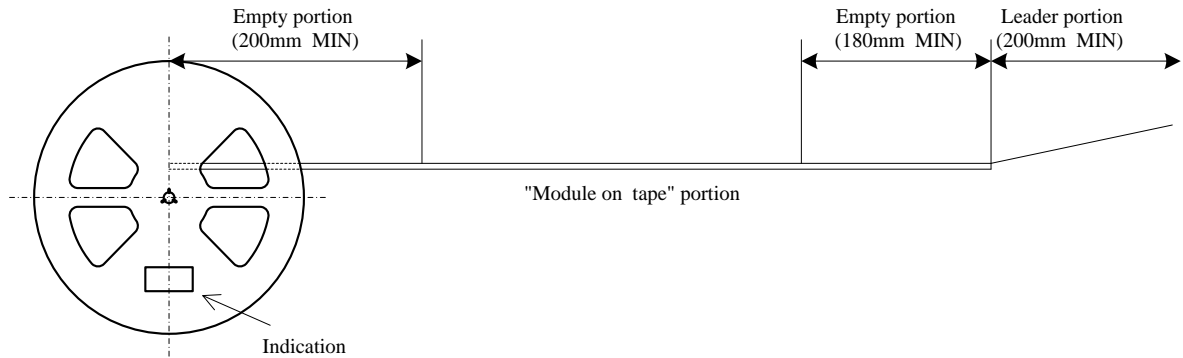

Figure 72. Tape Specifications

Notes

1. The adhesive strength of the protective tape must be within 0.1-1.3N.
2. Each reel contains the quantities such as the table below.
3. Each reel set in moisture-proof packaging because of MSL 3.
4. No vacant pocket in “Module on tape” section.
5. The reel is labeled with Murata part number and quantity.
6. The color of reel is not specified.

PART NUMBER	QTY
MYMGK1R806FRSR	400
MYMGK00506ERSR	400
MYMGK1R806FRSRD	100
MYMGK00506ERSRD	100

Soldering Guidelines

Murata recommends the specifications below when installing these converters. These specifications vary depending on the solder type.

Exceeding these specifications may cause damage to the product. Your production environment may differ therefore please thoroughly review these guidelines with your process engineers.

This product can be reflowed once.

Table 16. Reflow Solder Operations for Surface-Mount Products

For Sn/Ag/Cu BASED SOLDERS:	
Preheat Temperature	Less than 1degC per second
Time Over Liquidus.	45 to 75 seconds
Maximum Peak Temperature	250degC
Cooling Rate	Less than 3degC per second

Recommended Lead-free Solder Reflow Profile

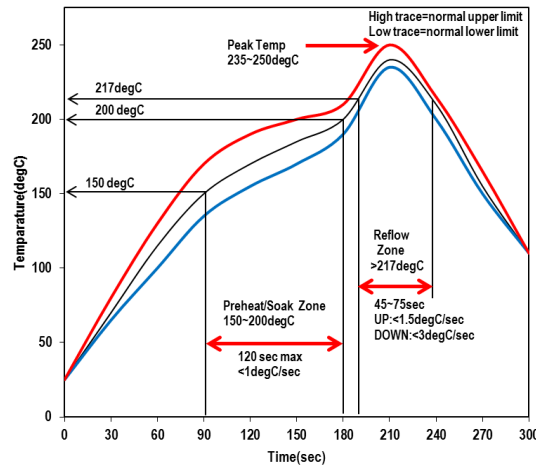
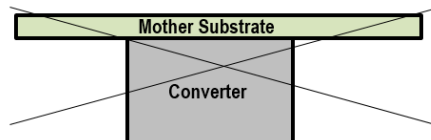

Figure 73. Recommended Lead-free Solder Reflow Profile

CAUTION: Do not reflow the converter as follows, because the converter may fall from the substrate during reflowing.



Pb-free Solder Processes

For Pb-free solder processes, the product is qualified for MSL 3 according to IPC/JEDEC standard J-STD-020D. During reflow PRODUCT must not exceed 250degC at any time.

Dry Pack Information

Products intended for Pb-free reflow soldering processes are delivered in standard moisture barrier bags according to IPC/JEDEC standard J-STD-033.

(Handling, packing, shipping and use of moisture/reflow sensitivity surface mount devices.)

Using products in high temperature Pb-free soldering processes requires dry pack storage and handling. In case the products have been stored in an uncontrolled environment and no longer can be considered dry, the modules must be baked according to J-STD-033.

Notices

Scope

This datasheet is applied to MYMGK1R806FRSR and MYMGK00506ERSR.
- Specific applications: Consumer Electronics, Industrial Equipment

CAUTION

Limitation of Applications

The products listed in the datasheet (hereinafter the product(s) is called the “Product(s)”) are designed and manufactured for applications specified in the specification or the datasheet. (hereinafter called the “Specific Application”). We shall not warrant anything in connection with the Products including fitness, performance, adequateness, safety, or quality, in the case of applications listed in from (1) to (11) written at the end of this precautions, which may generally require high performance, function, quality, management of production or safety. Therefore, the Product shall be applied in compliance with the specific application.

We disclaim any loss and damages arising from or in connection with the products including but not limited to the case such loss and damages caused by the unexpected accident, in event that (i) the product is applied for the purpose which is not specified as the specific application for the product, and/or (ii) the product is applied for any following application purposes from (1) to (11) (except that such application purpose is unambiguously specified as specific application for the product in our catalog specification forms, datasheets, or other documents officially issued by us*).

- (1) Aircraft equipment
- (2) Aerospace equipment
- (3) Undersea equipment
- (4) Power plant control equipment
- (5) Medical equipment
- (6) Transportation equipment (such as vehicles, trains, ships)
- (7) Traffic control equipment
- (8) Disaster prevention / crime prevention equipment
- (9) Industrial data-processing equipment
- (10) Combustion/explosion control equipment
- (11) Application of similar complexity and/or reliability requirements to the applications listed in the above

For exploring information of the Products which will be compatible with the particular purpose other than those specified in the datasheet, please contact our sales offices, distribution agents, or trading companies with which you make a deal, or via our web contact form.

Contact form: <https://www.murata.com/contactform>

*We may design and manufacture particular Products for applications listed in (1) to (11). Provided that, in such case we shall unambiguously specify such Specific Application in specification or datasheet without any exception. Therefore, any other documents and/or performances, whether exist or non-exist, shall not be deemed as the evidence to imply that we accept the applications listed in (1) to (11).

Fail-Safe Function

Be sure to add an appropriate fail-safe function to your finished product to prevent secondary damage in the unlikely event of an abnormality function or malfunction in our product.

Please connect the input terminal by right polarity. If you mistake the connection, it may break the DC-DC converter. In the case of destruction of the DC-DC converter inside, over input current may flow. Please add a diode and fuse as following to protect them.

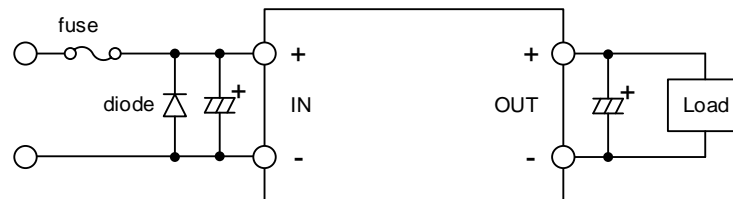

Please select diode and fuse after confirming the operation.

Figure 74. Circuit example with a diode and fuse

⚠ Note

1. Please make sure that your product has been evaluated in view of your specifications with our product being mounted to your product.
2. You are requested not to use our product deviating from the reference specifications.
3. If you have any concerns about materials other than those listed in the RoHS directive, please contact us.
4. Please don't wash this product under any conditions.

Product Specification

Product Specifications in this datasheet are as of December 2025. Specifications and features may change in any manner without notice. Please check with our sales representatives.

Contact Form

<https://www.murata.com/contactform?Product=Power%20Device>

Disclaimers

The information described in this data sheet was carefully crafted for accuracy. However this product is based on the assumption that it will be used after thoroughly verifying and confirming the characteristics and system compatibility. Therefore, Murata is not responsible for any damages caused by errors in the description of the datasheet.

Murata constantly strives to improve the quality and reliability of our products, but it is inevitable that semiconductor products will fail with a certain probability. Therefore regardless of whether the use conditions are within the range of this data sheet, Murata is not responsible for any damage caused by the failure of this product., (for example, secondary damage, compensation for accidents, punitive damage, loss of opportunity, and etc.) Also, regardless of whether Murata can foresee the events caused by the failure of our product, Murata has no obligations or responsibilities.

The buyer of this product and developer of systems incorporating this product must analyze, evaluate, and make judgements at their own risk in designing applications using this product. The buyer and the developer are responsible for verifying the safety of this product and the applications, and complying with all applicable laws, regulations, and other requirements.

Furthermore, the buyer and developer are responsible for predicting hazards and taking adequate safeguards against potential events at your own risk in order to prevent personal accidents, fire accidents, or other social damage. When using this product, perform thorough evaluation and verification of the safety design designed at your own risk for this product and the application.

Murata assumes that the buyer and developer have the expertise to verify all necessary issues for proper use of the product as described above and to take corrective action. Therefore, Murata has no liability arising out of the use of the product. The buyer and developer should take all necessary evaluations, verifications, corrective actions and etc., in your own responsibility and judgment.

This data sheet does not guarantee or grant any license to the information, including patents, copyrights, and other intellectual property rights, of the Murata or third parties. Regardless of whether the information described in this datasheet is express or implied, Murata does not take any responsibility or liability for any claims, damages, costs, losses, etc. relating to intellectual property rights or other rights from third parties due to the use of these information.

Patent Statement

Murata products are protected to under one or more of the U.S. patents.

Copyright and Trademark

©2025 Murata Manufacturing Co., Ltd. All rights reserved.



This product is subject to the following operating requirements and the Life and Safety Critical Application Sales Policy.

Refer to: <https://www.murata.com/products/power/requirements>

Murata Manufacturing Co., Ltd makes no representation that the use of its products in the circuits described herein, or the use of other technical information contained herein, will not infringe upon existing or future patent rights. The descriptions contained herein do not imply the granting of licenses to make, use, or sell equipment constructed in accordance therewith. Spec and cautions are subject to change without notice.

Looking for pricing, stock, or lifecycle information?

Click below to explore more details on WIN SOURCE:

- ⊖ [View MYMGK00506ERSR on WIN SOURCE](#)
- ⊖ [Murata Power Solutions Inc. Information](#)

Optimize Your Supply Chain with WIN SOURCE Solutions

- ✓ Global Sourcing Solution
- ✓ Obsolete Management
- ✓ Cost Control Management
- ✓ Shortage Management
- ✓ Alternative Solution
- ✓ Excess Inventory Management