

Features

Unregulated Converters

- SMD case style
- Tape and reel packaging
- UL60950-1 certified
- High operating temperature range from -40°C to +100°C at full load
- Efficiency up to 76%
- 2kVDC/1s isolation

RECOM

DC/DC Converter

R1SE/H2

1 Watt
SMD
Single Output



Description

The R1SE/H2 series are 1W unregulated DC/DC converters that are lower cost than equivalent converters. The benefits of high volume production and semi-automatic assembly allow for a lower selling price without sacrificing our high quality standards. They are UL certified for safety, offer reasonable efficiency and still meet the full industrial operating temperature range of -40° to +100°C. All converters are 100% tested in production and carry our 3-year warranty.

Selection Guide

Part Number	Input Voltage [VDC]	Output Voltage [VDC]	Output Current [mA]	Efficiency typ. ⁽¹⁾ [%]	max. Capacitive Load ⁽²⁾ [µF]
R1SE-3.305/H2-R	3.3	5	200	75	1000
R1SE-0505/H2-R	5	5	200	75	1000
R1SE-0512/H2-R	5	12	84	76	330
R1SE-0515/H2-R	5	15	66	76	220
R1SE-1205/H2-R	12	5	200	73	1000
R1SE-1505/H2-R	15	5	200	74	1000

Notes:

Note1: Efficiency is tested at nominal input and full load at +25°C ambient

Note2: Max. capacitive load is defined as the capacitive load that will allow start up in under 1 second without damage to the converter



UL60950-1 certified
 CAN/CSA-C22.2 No. 60950-1-07 certified
 EN55032 compliant

Model Numbering

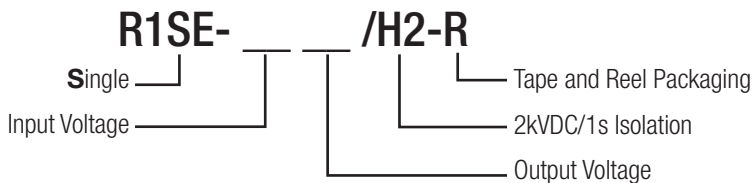

Ordering Examples:

R1SE-0505/H2-R: Single Output, 5VDC Input, 5VDC Output, 2kVDC/1s isolation and tape and reel packaging

Specifications (measured at $T_a=25^\circ\text{C}$, nominal input voltage and rated current unless otherwise specified)

BASIC CHARACTERISTICS

Parameter	Condition	Min.	Typ.	Max.
Input Voltage Range			$\pm 10\%$	
Internal Operating Frequency		20kHz	60kHz	100kHz
Output Ripple and Noise ⁽³⁾	20MHz BW		50mVp-p	100mVp-p

Notes:

Note3: Measurements are made with a 100nF MLCC across output (low ESR)

Efficiency vs. Load

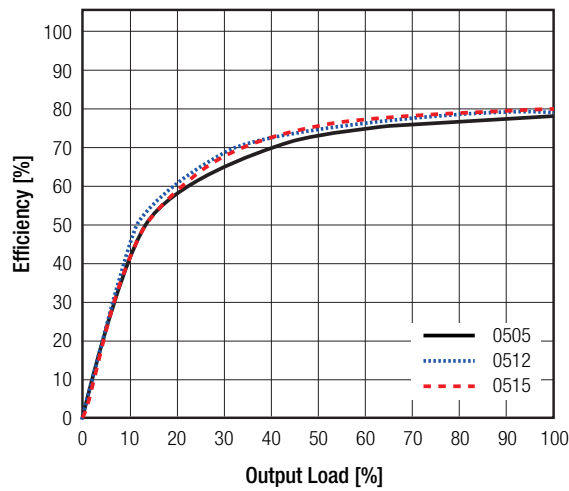

REGULATIONS

Parameter	Condition	Value
Output Accuracy		-2.0% typ. / $\pm 5.0\%$ max.
Line Regulation	low line to high line, full load	$\pm 1.0\%$ typ. / $\pm 1.5\%$ max.
Load Regulation	20% to 100% load	6.0% typ. / 10.0% max.

Tolerance Envelope

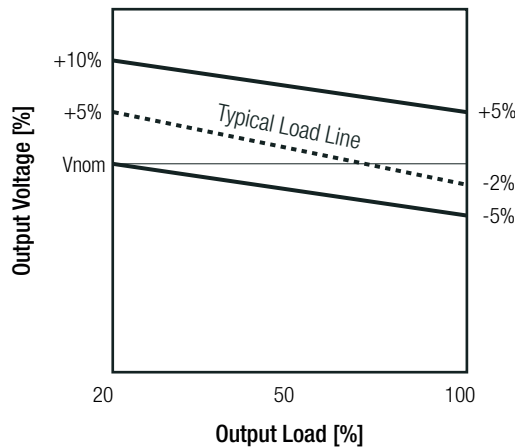

continued on next page

Specifications (measured at $T_a = 25^\circ\text{C}$, nominal input voltage and rated current unless otherwise specified)

Deviation vs. Load

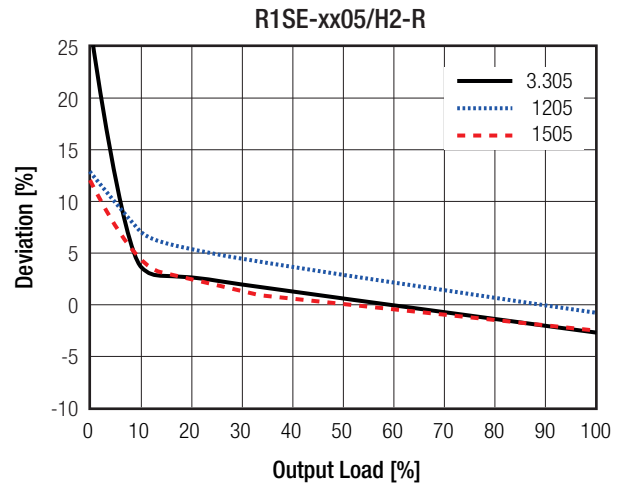
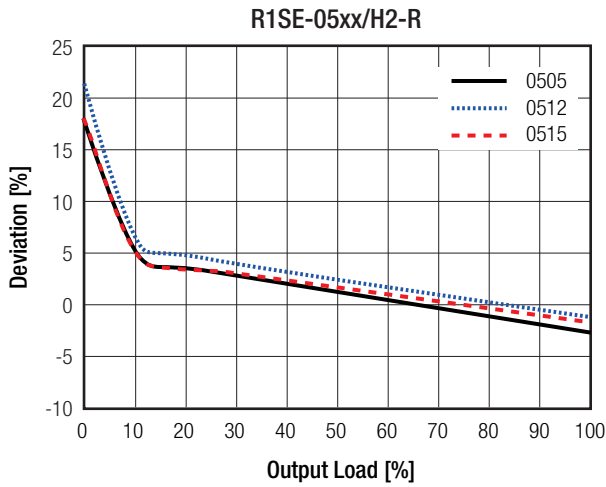

PROTECTIONS

Parameter	Type		Value
Isolation Voltage	I/P to O/P	tested for 1 second	2kVDC
Isolation Resistance	Viso = 500V		10GΩ min.
Isolation Capacitance			75pF max.

Notes:

Note4: Refer to local safety regulations if input over-current protection is also required. Recommended fuse: slow blow type

ENVIRONMENTAL

Parameter	Condition		Value
Operating Temperature Range	full load @ free air convection		-40°C to +100°C
Operating Altitude			2000m
Operating Humidity	non-condensing		95% RH max.
Pollution Degree			PD2
MTBF	according to MIL-HDBK-217F, G.B.	+25°C	2992 x 10 ³ hours
		+85°C	955 x 10 ³ hours

Derating Graph

(@ free air convection)

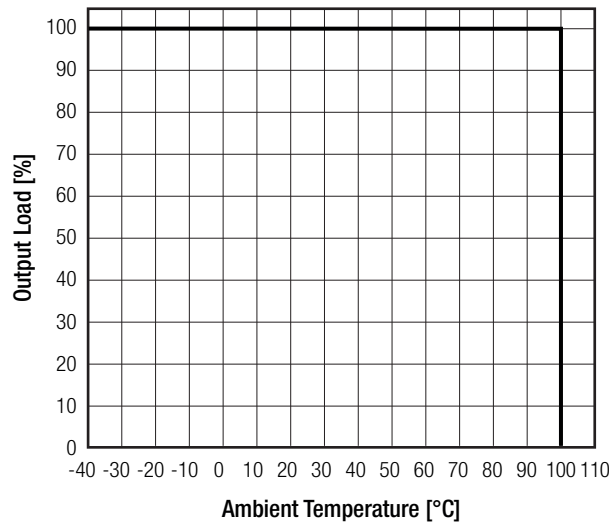

Specifications (measured at $T_a = 25^\circ\text{C}$, nominal input voltage and rated current unless otherwise specified)

SAFETY AND CERTIFICATIONS

Certificate Type (Safety)	Report / File Number	Standard
Information Technology Equipment, General Requirements for Safety	E358085-A2-UL	UL60950-1, 2nd Edition:2007 CAN/CSA C22.2 No. 60950-1-03, 2nd Edition:2007
RoHS 2		RoHS-2011/65/EU + AM-2015/863

EMC Compliance	Condition	Standard / Criterion
Electromagnetic compatibility of multimedia equipment - Emission requirements	with external filter	EN55032, Class B EN55032, Class A

EMC Filter Suggestion according to EN55032

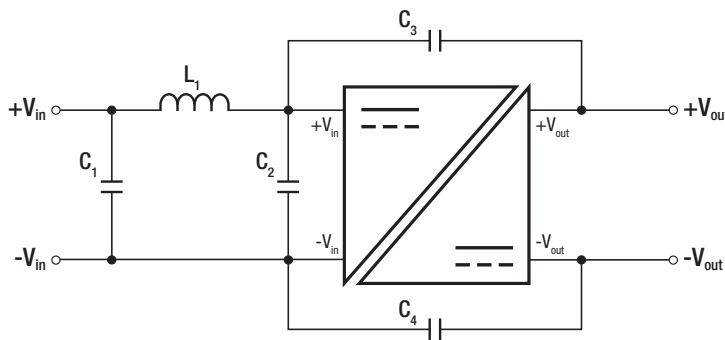

Component List Class A

MODEL	C1	L1	C2	C3 and C4
R1SE-0505/H2	N/A	N/A	6.8 μF	N/A
R1SE-0512/H2			50V MLCC	
R1SE-1205/H2			10 μF	
R1SE-1505/H2			100V MLCC	

Component List Class B

MODEL	C1	L1	C3 (safety)	C4 (safety)
R1SE-0505/H2	10 μF 100V MLCC	12 μH choke RLS-126	330pF	330pF
R1SE-0512/H2				
R1SE-1205/H2				
R1SE-1505/H2				

Notes:

Note5: Filter suggestions are valid for indicated part numbers only. For other part numbers, please contact RECOM tech support for advice

DIMENSION AND PHYSICAL CHARACTERISTICS

Parameter	Type	Value
Material	case	non-conductive black plastic (UL94 V-0)
Dimension (LxWxH)		12.75 x 10.7 x 7.0mm
Weight		1.0g typ.

continued on next page

Specifications (measured at $T_a = 25^\circ\text{C}$, nominal input voltage and rated current unless otherwise specified)

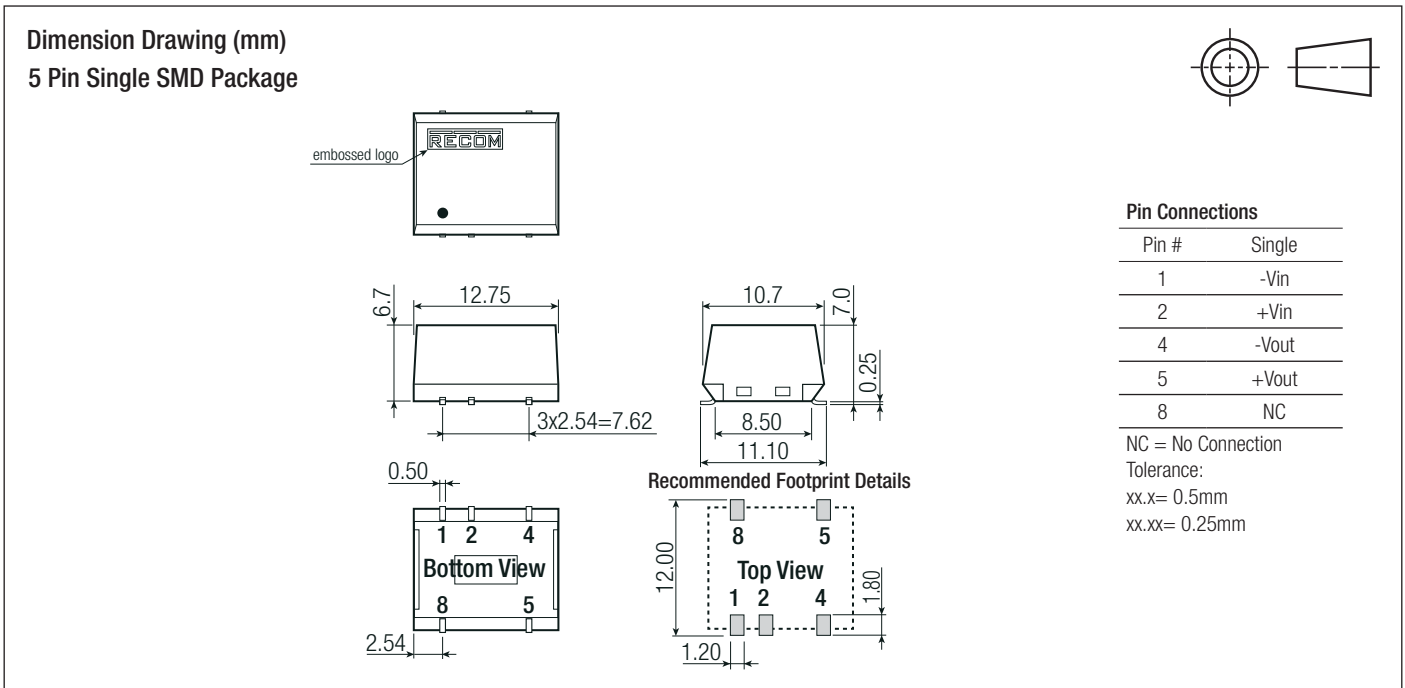

PACKAGING INFORMATION

Packaging Dimension (LxWxH)	tape and reel (carton)	355.0 x 340.0 x 35.0mm
Packaging Quantity	tape and reel	500pcs
Tape Width		24.0mm
Storage Temperature Range		-55°C to +125°C
Storage Humidity		95% RH max.

The product information and specifications may be subject to changes even without prior written notice. The product has been designed for various applications; its suitability lies in the responsibility of each customer. The products are not authorized for use in safety-critical applications without RECOM's explicit written consent. A safety-critical application is an application where a failure may reasonably be expected to endanger or cause loss of life, inflict bodily harm or damage property. The applicant shall indemnify and hold harmless RECOM, its affiliated companies and its representatives against any damage claims in connection with the unauthorized use of RECOM products in such safety-critical applications.

Looking for pricing, stock, or lifecycle information?

Click below to explore more details on WIN SOURCE:

- [View R1SE-0512/H2-R on WIN SOURCE](#)
- [Recom Power Information](#)

Optimize Your Supply Chain with WIN SOURCE Solutions

- ✓ Global Sourcing Solution
- ✓ Obsolete Management
- ✓ Cost Control Management
- ✓ Shortage Management
- ✓ Alternative Solution
- ✓ Excess Inventory Management