

GaAs pHEMT MMIC LOW NOISE AGC AMPLIFIER, 2 - 20 GHz

Typical Applications

The HMC463LH250 is ideal for:

- Telecom Infrastructure
- Microwave Radio & VSAT
- Military EW, ECM & C³I
- Test Instrumentation
- Fiber Optics

Features

- 50 Ohm Matched Input/Output
- Hermetic SMT Package
- Gain: 14 dB
- Noise Figure: 2.5 dB @ Mid-Band
- P1dB Output Power: +18 dBm @ Mid-Band
- Supply Voltage: +5V @ 60mA
- Screening to MIL-PRF-38535 (Class B or S) Available

Functional Diagram

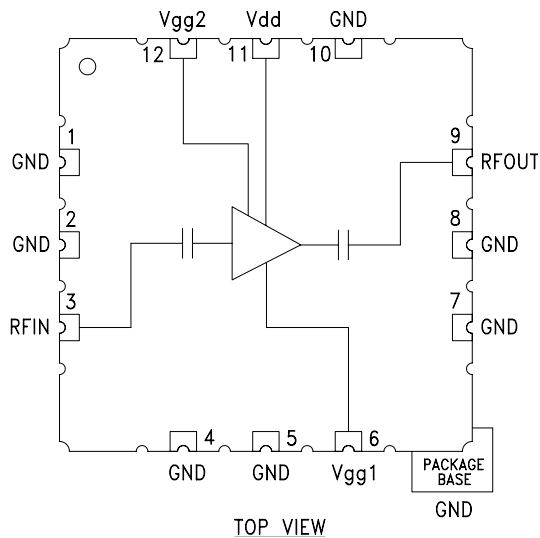

General Description

The HMC463LH250 is a GaAs MMIC pHEMT Low Noise AGC Distributed Amplifier packaged in a hermetic surface mount package which operates between 2 and 20 GHz. The amplifier provides 13 dB of gain, 3 dB noise figure and 18 dBm of output power at 1 dB gain compression while requiring only 60 mA from a +5V supply. An optional gate bias (Vgg2) is provided to allow Adjustable Gain Control (AGC) of 8 dB typical. Gain flatness is excellent at ± 0.5 dB from 2 - 14 GHz making the HMC463LH250 ideal for EW, ECM RADAR, test equipment and High-Reliability applications. The HMC463LH250 LNA I/Os are internally matched to 50 Ohms and are internally DC blocked.

Electrical Specifications, $T_A = +25^\circ\text{C}$, $V_{dd} = 5\text{V}$, $V_{gg2} = \text{Open}$, $I_{dd} = 60\text{ mA}^*$

Parameter	Min.	Typ.	Max.	Min.	Typ.	Max.	Min.	Typ.	Max.	Units
Frequency Range	2.0 - 6.0			6.0 - 16.0			16.0 - 20.0			GHz
Gain	11.5	14.5		9	12		8	11		dB
Gain Flatness		± 0.25			± 0.5			± 0.9		dB
Gain Variation Over Temperature		0.010			0.010			0.010		dB/°C
Noise Figure		3.5	5.5		2.5	4.5		4	5.5	dB
Input Return Loss		15			15			9		dB
Output Return Loss		11			15			7		dB
Output Power for 1 dB Compression (P1dB)	16	19		13	18		10	13		dBm
Saturated Output Power (Psat)		21.5			20.5			19		dBm
Output Third Order Intercept (IP3)		29			27			24		dBm
Supply Current (Idd) (Vdd= 5V, Vgg1= -0.9V Typ.)		60	80		60	80		60	80	mA

* Adjust Vgg1 between -2 to -0V to achieve Idd= 60 mA typical.

GaAs pHEMT MMIC LOW NOISE AGC AMPLIFIER, 2 - 20 GHz

Gain & Return Loss

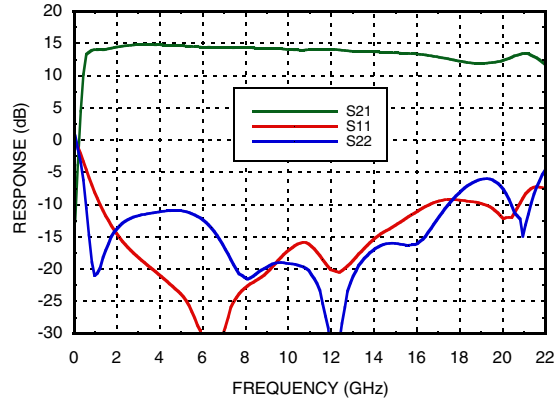

Gain vs. Temperature

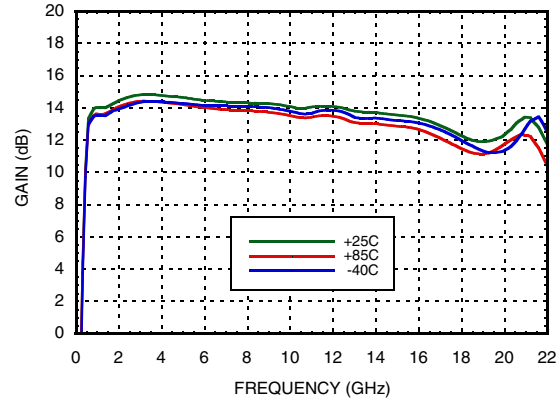

Input Return Loss vs. Temperature

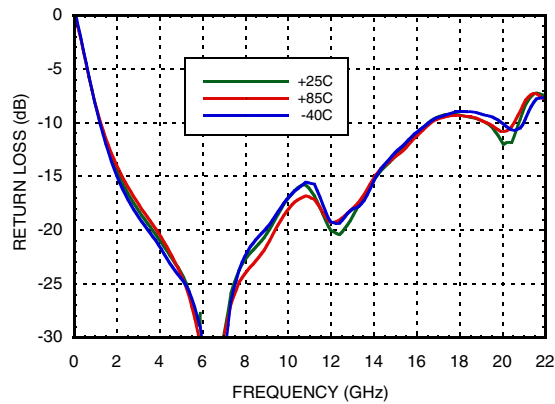

Output Return Loss vs. Temperature

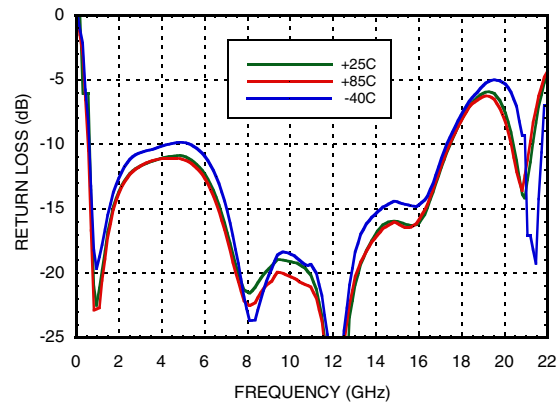

Reverse Isolation vs. Temperature

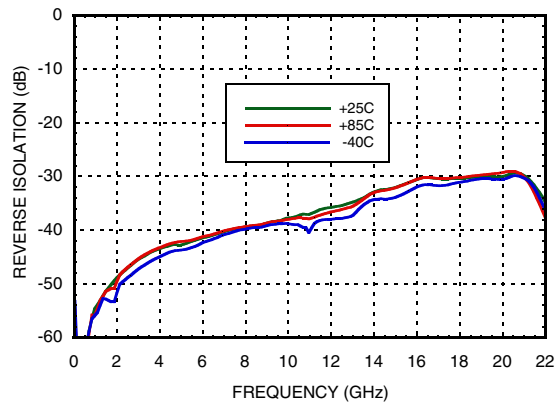

Noise Figure vs. Temperature

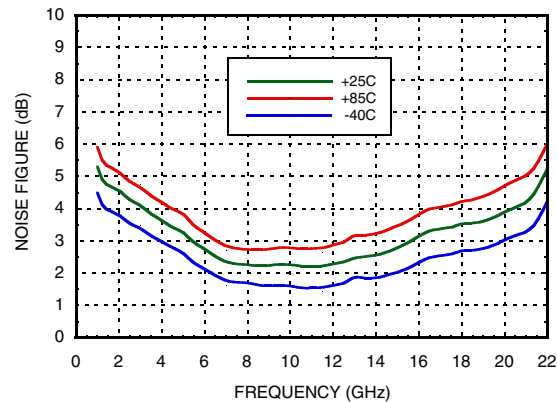

GaAs pHEMT MMIC LOW NOISE AGC AMPLIFIER, 2 - 20 GHz

P1dB vs. Temperature

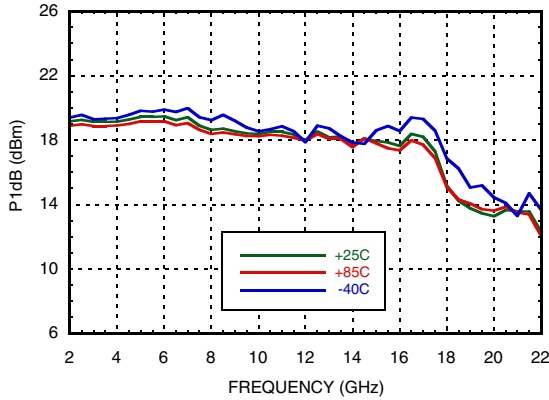

Psat vs. Temperature

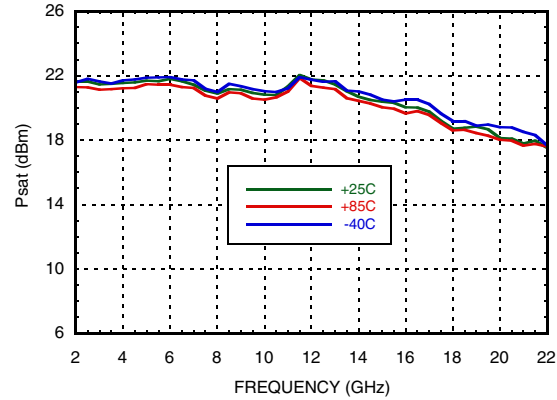

Output IP3 vs. Temperature

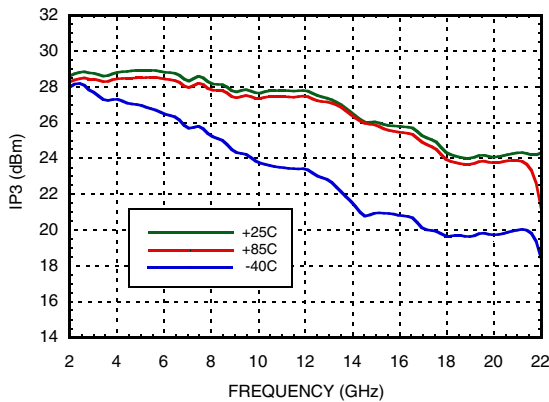

Gain, Power & Noise Figure vs. Supply Voltage @ 10 GHz, Fixed Vgg1

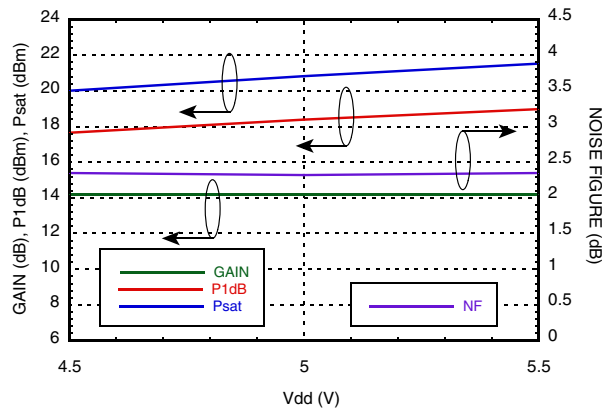

Gain, P1dB & Output IP3 vs. Control Voltage @ 10 GHz

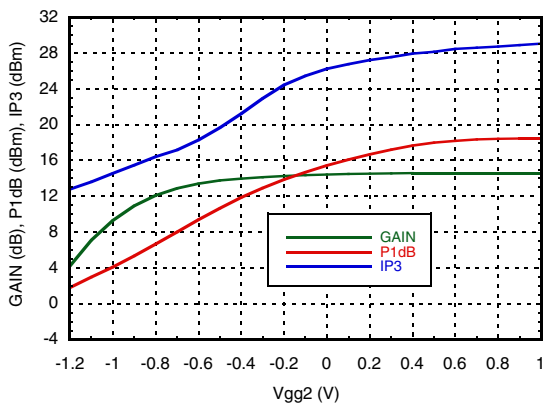

Noise Figure & Supply Current vs. Control Voltage @ 10 GHz

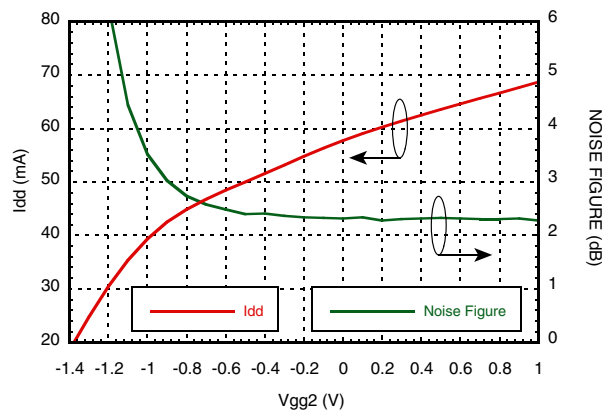

GaAs pHEMT MMIC LOW NOISE AGC AMPLIFIER, 2 - 20 GHz

Gain @ Several Control Voltages

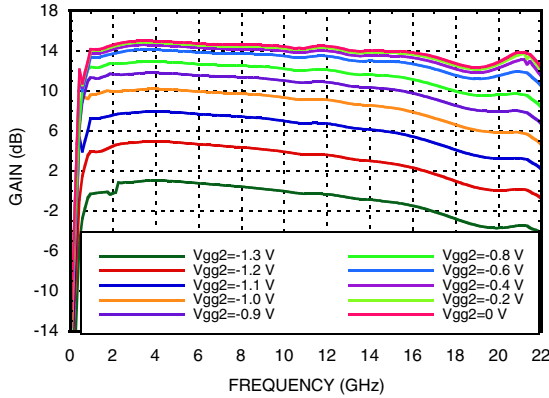

ELECTROSTATIC SENSITIVE DEVICE
OBSERVE HANDLING PRECAUTIONS

Absolute Maximum Ratings

Drain Bias Voltage (V _{dd})	+9 V
Gate Bias Voltage (V _{gg1})	-2 to 0 V _{dc}
Gate Bias Current (I _{gg1})	2.5 mA
Gate Bias Voltage (V _{gg2})(AGC)	(V _{dd} -9) V _{dc} to +2 V _{dc}
RF Input Power (RFIN)(V _{dd} = +5 V)	+18 dBm
Channel Temperature	175 °C
Storage Temperature	-65 to +150 °C
Operating Temperature	-40 to +85 °C
ESD Sensitivity (HBM)	Class 0B - Passed 150V

Typical Supply Current vs. V_{dd}

V _{dd} (V)	I _{dd} (mA)
+4.5	58
+5.0	60
+5.5	62

Outline Drawing

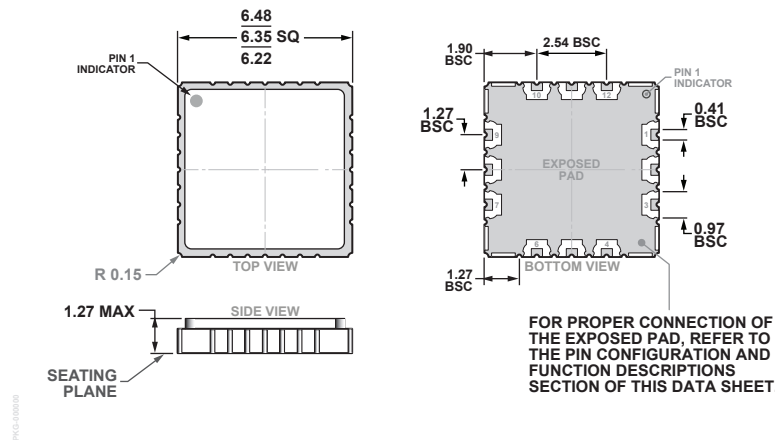

12-Terminal Ceramic Leadless Chip Carrier [LCC]
(E-12-2)

Dimensions shown in millimeters.

Package Information

Part Number	Package Body Material	Lead Finish	MSL Rating	Package Marking ^[2]
HMC463LH250	Ceramic & Kovar	Au	MSL1 ^[1]	H463 XXXX

[1] Max peak reflow temperature of 250 °C

[2] 4-Digit lot number XXXX

GaAs pHEMT MMIC LOW NOISE AGC AMPLIFIER, 2 - 20 GHz

Pin Descriptions

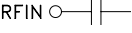
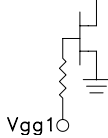
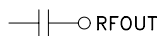
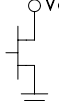
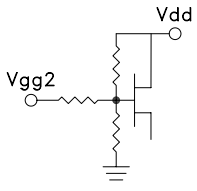
Pin Number	Function	Description	Interface Schematic
1, 2, 4, 5, 7, 8, 10	GND	Ground paddle must be connected to RF/DC ground.	
3	RFIN	This pad is AC coupled and matched to 50 Ohms.	
6	Vgg1	Gate control for amplifier. Adjust to achieve I _{dd} = 60 mA.	
9	RFOUT	This pad is AC coupled and matched to 50 Ohms.	
11	Vdd	Power supply voltage for the amplifier. External bypass capacitors are required	
12	Vgg2	Optional gate control if AGC is required. Leave Vgg2 open circuited if AGC is not required.	

GaAs pHEMT MMIC LOW NOISE AGC AMPLIFIER, 2 - 20 GHz

Evaluation PCB

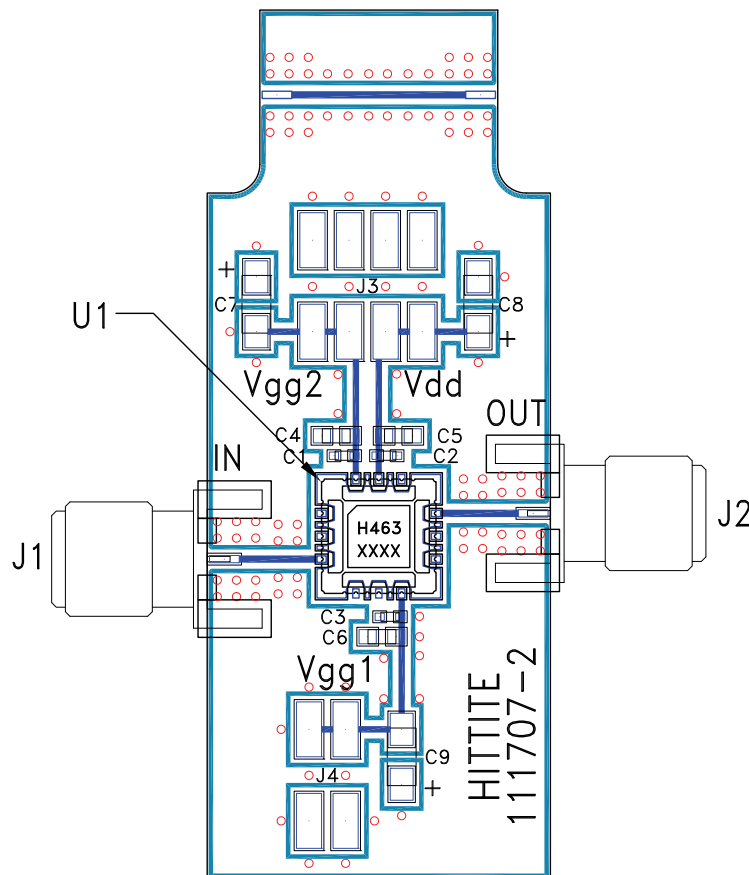

List of Materials for Evaluation PCB 111709 [1]

Item	Description
J1 - J2	SRI K Connector
J3 - J4	2 mm Molex Header
C1 - C3	100 pF Capacitor, 0402 Pkg.
C4 - C6	1000 pF Capacitor, 0603 Pkg.
C7 - C9	4.7 μ F Capacitor, Tantalum
U1	HMC463LH250
PCB [2]	111707 Evaluation PCB



[1] Reference this number when ordering complete evaluation PCB

[2] Circuit Board Material: Rogers 4350

The circuit board used in the application should use RF circuit design techniques. Signal lines should have 50 Ohm impedance while the package ground leads and package bottom should be connected directly to the ground plane similar to that shown. A sufficient number of via holes should be used to connect the top and bottom ground planes. The evaluation board should be mounted to an appropriate heat sink. The evaluation circuit board shown is available from Analog Devices upon request.

Looking for pricing, stock, or lifecycle information?

Click below to explore more details on WIN SOURCE:

-  [View HMC463LH250TR on WIN SOURCE](#)
-  [Analog Devices Inc. Information](#)

Optimize Your Supply Chain with WIN SOURCE Solutions

-  Global Sourcing Solution
-  Obsolete Management
-  Cost Control Management
-  Shortage Management
-  Alternative Solution
-  Excess Inventory Management