

### FEATURES

- UL 60950 recognised<sup>3</sup>
- Single isolated output
- 1kVDC or 3kVDC option 'Hi Pot Test'
- Wide temperature performance at full 1W load -40°C to 85°C<sup>4</sup>
- Industry standard pinout
- 3.3V, 5V, 12V & 24V inputs
- 5V, 12V & 15V outputs
- Pin compatible with CME, CRL2, LME, MEE1, MEE3, MTE1, NKE, NME, NML & NTE series
- Through hole and surface mount options available

### PRODUCT OVERVIEW

The CRE1 series are a cost effective 1W DC-DC converter series, in industry standard packages with industry standard pinout. Popular input and output voltages are available. The galvanic isolation allows the device to be configured to provide an isolated negative rail in systems where only positive rails exist. The wide temperature range guarantees startup from -40°C and full 1 watt output at 85°C<sup>3</sup>.

### SELECTION GUIDE

Order Code <sup>1</sup>	Nominal Input Voltage	Output Voltage	Output Current	Load Regulation		Ripple & Noise		Input Current at Rated Load	Efficiency		Isolation Capacitance	MTTF <sup>2</sup>		
				%		mV p-p			%			pF	MIL. kHrs	Tel.
				Typ.	Max.	Typ.	Max.		Min.	Typ.				
CRE1S0505DC	5	5	200	12	14	16	40	286	65	70	30	3415		
CRE1S0505SC	5	5	200	12	14	16	40	286	65	70	30	3415		
CRE1S0515SC	5	15	67	6	7.5	10	25	250	77	80	40	1532		
CRE1S1205SC	12	5	200	8	10	12	30	117	68	71	33	2493		
CRE1S1212SC	12	12	83	4	5	8	20	104	75	80	55	1780		
CRE1S2405SC	24	5	200	8.5	10	13	30	58	67	71	40	201		
CRE1S2412SC	24	12	83	3	4	10	25	52	75	80	78	163		
<b>3kVDC isolation options</b>														
CRE1S0305S3C	3.3	5	200	10	12	15	25	400	72	75	35	4105	46783	
CRE1S0505S3C	5	5	200	6	8	15	25	250	73	77	24	4227	34897	
<b>Surface mount options</b>														
CRE1S0505MC	5	5	200	12.8	15	62	85	294		68	35	6857		
CRE1S0505MEC	5	5	200	6.5	8	25	70	239	79	82	22	3041		

### INPUT CHARACTERISTICS

Parameter	Conditions	Min.	Typ.	Max.	Units
Voltage range	Continuous operation, 3.3V input types	2.97	3.3	3.63	V
	Continuous operation, 5V input types	4.5	5.0	5.5	
	Continuous operation, 12V input types	10.8	12	13.2	
	Continuous operation, 24V input types	21.6	24	26.4	
Reflected ripple current	3.3V & 12V input types		1	15	mA p-p
	5V & 24V input types		2	15	
	CRE1S0505MC		30	47	
	CRE1S0505MEC		5	15	

### OUTPUT CHARACTERISTICS

Parameter	Conditions	Min.	Typ.	Max.	Units
Rated Power	T <sub>A</sub> =-40°C to 85°C <sup>3</sup>			1	W
Voltage Set Point Accuracy	See tolerance envelope				
Line regulation	High V <sub>IN</sub> to low V <sub>IN</sub>		1.1	1.2	%/%

### ISOLATION CHARACTERISTICS

Parameter	Conditions	Min.	Typ.	Max.	Units
Isolation test voltage	C Versions Flash tested for 1 second	1000			VDC
	3C Versions Flash tested for 1 second	3000			
Resistance	Viso= 1000VDC		10		GΩ

### GENERAL CHARACTERISTICS

Parameter	Conditions	Min.	Typ.	Max.	Units
Switching frequency	3.3V input types		115		kHz
	5V input types		110		
	12V input types		145		
	24V input types		100		
	CRE1S0505MEC		80		

1. If components are required in tape and reel format suffix order code with -R, e.g. CRE1S0505MC-R.
2. Calculated using MIL-HDBK-217 FN2 and Telcordia SR-332 calculation model with nominal input voltage at full load.
3. UL 60950 recognition does not apply to CRE1S0505MC.
4. 24V input parts prior to date code D1635 have operating temperature range of 0 to 70°C.

All specifications typical at T<sub>A</sub>=25°C, nominal input voltage and rated output current unless otherwise specified.



For full details go to  
<https://www.murata.com/en-global/products/power/rohs>



ABSOLUTE MAXIMUM RATINGS	
Lead temperature 1.5mm from case for 10 seconds	260°C
Wave Solder	Wave Solder profile not to exceed the profile recommended in IEC 61760-1 Section 6.1.3. Please refer to <a href="#">application notes</a> for further information.
Input voltage $V_{IN}$ , 3.3V input	5.5V
Input voltage $V_{IN}$ , 5V input	7V
Input voltage $V_{IN}$ , 12V input	15V
Input voltage $V_{IN}$ , 24V input	28V

TEMPERATURE CHARACTERISTICS					
Parameter	Conditions	Min.	Typ.	Max.	Units
Specification	See safety approval section for UL temperature specification <sup>1</sup>	-40		85	°C
Storage		-50		130	
Case temperature rise above ambient	5V output types			41	
	All other output types			32	
	CRE1S0505MC		43		
	CRE1S0505MEC		12.5		
Cooling	Free air convection				

1. 24V input parts prior to date code D1635 have operating temperature range of 0 to 70°C.

## TECHNICAL NOTES

### ISOLATION VOLTAGE

'Hi Pot Test', 'Flash Tested', 'Withstand Voltage', 'Proof Voltage', 'Dielectric Withstand Voltage' & 'Isolation Test Voltage' are all terms that relate to the same thing, a test voltage, applied for a specified time, across a component designed to provide electrical isolation, to verify the integrity of that isolation.

Murata Power Solutions CRE1 series of DC-DC converters are all 100% production tested at their stated isolation voltage. This is 1kVDC for 1 second for C versions and 3kVDC for 1 second for 3C versions.

A question commonly asked is, "What is the continuous voltage that can be applied across the part in normal operation?"

The CRE1 series, through hole variants (excluding surface mount variants) have been recognised by Underwriters Laboratory for functional insulation, both input and output should normally be maintained within SELV limits i.e. less than 42.4V peak, or 60VDC. The isolation test voltage represents a measure of immunity to transient voltages and the part should never be used as an element of a safety isolation system. The part could be expected to function correctly with several hundred volts offset applied continuously across the isolation barrier; but then the circuitry on both sides of the barrier must be regarded as operating at an unsafe voltage and further isolation/insulation systems must form a barrier between these circuits and any user-accessible circuitry according to safety standard requirements.

### REPEATED HIGH-VOLTAGE ISOLATION TESTING

It is well known that repeated high-voltage isolation testing of a barrier component can actually degrade isolation capability, to a lesser or greater degree depending on materials, construction and environment. The CRE1 series has toroidal isolation transformers, with no additional insulation between primary and secondary windings of enamelled wire. While parts can be expected to withstand several times the stated test voltage, the isolation capability does depend on the wire insulation. Any material, including this enamel (typically polyurethane) is susceptible to eventual chemical degradation when subject to very high applied voltages thus implying that the number of tests should be strictly limited. We therefore strongly advise against repeated high voltage isolation testing, but if it is absolutely required, that the voltage be reduced by 20% from specified test voltage.

This consideration equally applies to agency recognised parts rated for better than functional isolation where the wire enamel insulation is always supplemented by a further insulation system of physical spacing or barriers.

## SAFETY APPROVAL

The CRE1 series has been recognised by Underwriters Laboratory (UL) to UL60950 for functional insulation in a maximum still air ambient temperature of 100°C for the C versions and 130°C for the 3C versions as measured on the case of the unit (hotspot). The CRE1S0505MC is not currently UL recognised.

The CRE1 series of converters are not internally fused so to meet the requirements of UL60950 an anti-surge input line fuse should always be used with ratings as defined below.

CRE1S03xxS3C: 1A  
 CRE1S05xxxxC: 0.7A  
 CRE1S12xxSC: 0.2A  
 CRE1S24xxSC: 0.16A

All fuses should be UL recognised, 125V rated.

File number E151252 applies.

## RoHS COMPLIANCE, MSL AND PSL INFORMATION

The Through Hole parts (SIP/DIP) in this series are compatible with RoHS soldering systems with a peak wave solder temperature of 260°C for 10 seconds. Please refer to [application notes](#) for further information. The pin termination finish on the SIP package type is Tin Plate, Hot Dipped over Matte Tin with Nickel Preplate. The DIP types are Matte Tin over Nickel Preplate. This series is backward compatible with Sn/Pb soldering systems.

The Surface Mount parts (MC) in this series are compatible with RoHS soldering systems and are also backward compatible with Sn/Pb soldering systems. The Surface Mount parts (MC) in this series have a process, moisture and reflow sensitivity classification of MSL1 PSL R7F as defined in J-STD-020 and J-STD-075. This translates to: MSL1 = unlimited floor life, PSL R7F = Peak reflow temperature 245°C with a limitation on the time above liquidus (217°C) which for this series is 60sec max. The pin termination finish on this product series is Gold with a plating thickness of 0.05 microns minimum.

The Surface Mount parts (MEC) in this series are compatible with RoHS soldering systems and are also backward compatible with Sn/Pb soldering systems. The Surface Mount parts (MEC) in this series have a process, moisture and reflow sensitivity classification of MSL1 PSL R7F as defined in J-STD-020 and J-STD-075. This translates to: MSL1 = unlimited floor life, PSL R7F = Peak reflow temperature 245°C with a limitation on the time above liquidus (217°C) which for this series is 140sec max. The pin termination finish on this product series is Matte Tin over Nickel Preplate.

For further information, please visit <https://www.murata.com/en-global/products/power/rohs>



**PART NUMBER STRUCTURE**

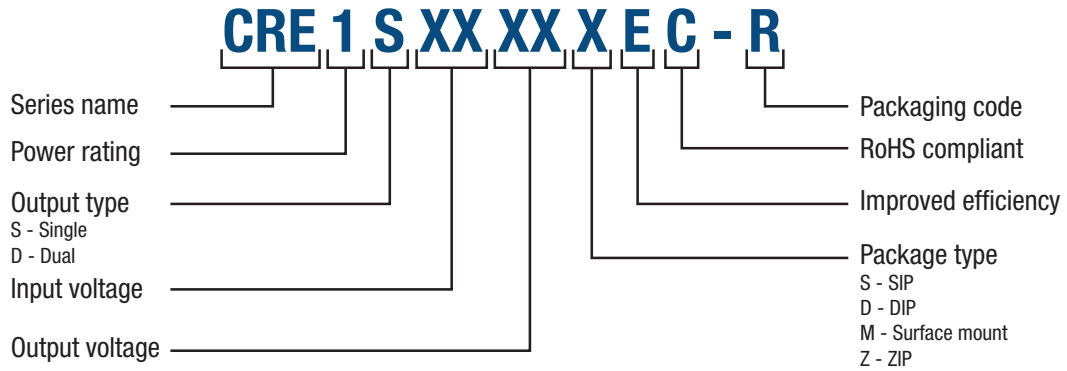

**CHARACTERISATION TEST METHODS**

**Ripple & Noise Characterisation Method**

Ripple and noise measurements are performed with the following test configuration.

C1	1µF X7R multilayer ceramic capacitor, voltage rating to be a minimum of 3 times the output voltage of the DC-DC converter
C2	10µF tantalum capacitor, voltage rating to be a minimum of 1.5 times the output voltage of the DC-DC converter with an ESR of less than 100mΩ at 100 kHz
C3	100nF multilayer ceramic capacitor, general purpose
R1	450Ω resistor, carbon film, ±1% tolerance
R2	50Ω BNC termination
T1	3T of the coax cable through a ferrite toroid
RLOAD	Resistive load to the maximum power rating of the DC-DC converter. Connections should be made via twisted wires

Measured values are multiplied by 10 to obtain the specified values.

**Differential Mode Noise Test Schematic**

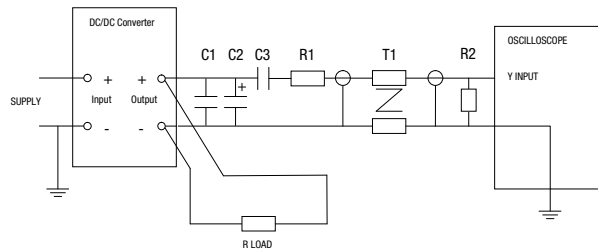

**APPLICATION NOTES**

**Minimum load**

The minimum load to meet datasheet specification is 10% of the full rated load across the specified input voltage range. Lower than 10% minimum loading will result in an increase in output voltage, which may rise to typically double the specified output voltage if the output load falls to less than 5%.

**Capacitive loading and start up**

Typical start up times for this series, with a typical input voltage rise time of 2.2µs and output capacitance of 10µF, are shown in the table below. The product series will start into a capacitance of 47µF with an increased start time, however, the maximum recommended output capacitance is 10µF.

	Start-up time
	µs
CRE1S0505DC	190
CRE1S0505SC	190
CRE1S0515SC	1790
CRE1S1205SC	125
CRE1S1212SC	500
CRE1S2405SC	135
CRE1S2412SC	430
CRE1S0305S3C	295
CRE1S0505S3C	165
CRE1S0505MC	1368
CRE1S0505MEC	170

**Typical Start-Up Wave Form**



**APPLICATION NOTES (Continued)**

**Output Ripple Reduction**

By using the values of inductance and capacitance stated, the output ripple at the rated load is lowered to 5mV p-p max.

**Component selection**

**Capacitor:** It is required that the ESR (Equivalent Series Resistance) should be as low as possible, ceramic types are recommended. The voltage rating should be at least twice (except for 15V output), the rated output voltage of the DC-DC converter.

**Inductor:** The rated current of the inductor should not be less than that of the output of the DC-DC converter. At the rated current, the DC resistance of the inductor should be such that the voltage drop across the inductor is <2% of the rated voltage of the DC-DC converter. The SRF (Self Resonant Frequency) should be >20MHz.

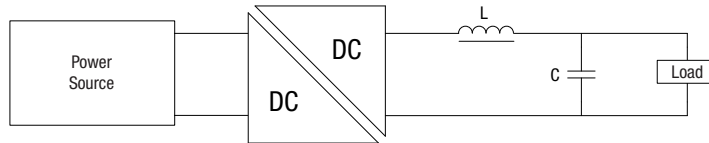

	Inductor			Capacitor
	L, $\mu$ H	SMD	Through Hole	C, $\mu$ F
CRE1S0505DC				
CRE1S0505SC				
CRE1S0515SC				
CRE1S1205SC				
CRE1S1212SC				
CRE1S2405SC				
CRE1S2412SC				
CRE1S0305S3C				
CRE1S0505S3C				
CRE1S0505MC	47	82473C	11R473C	4.7
CRE1S0505MEC	10	82103C	11R103C	4.7

## TOLERANCE ENVELOPES

The voltage tolerance envelope shows typical load regulation characteristics for this product series. The tolerance envelope is the maximum output voltage variation due to changes in output loading.

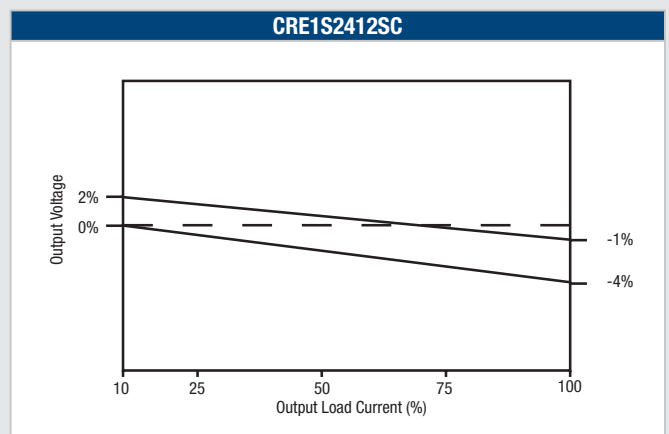
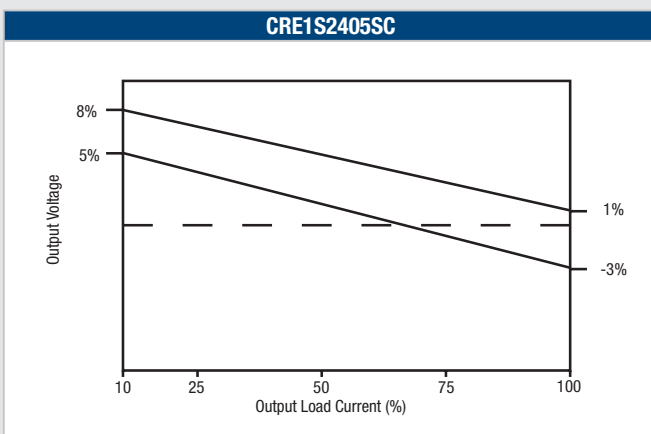
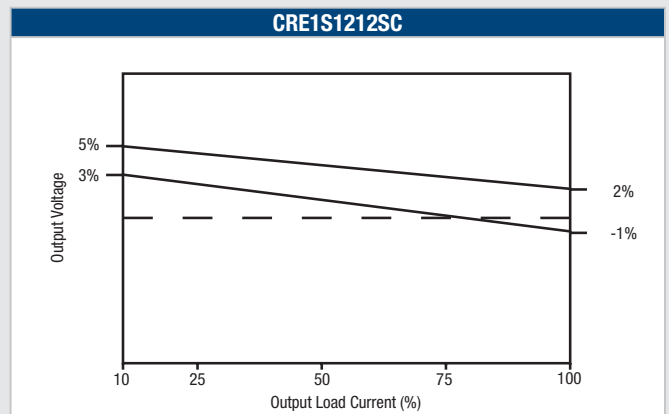
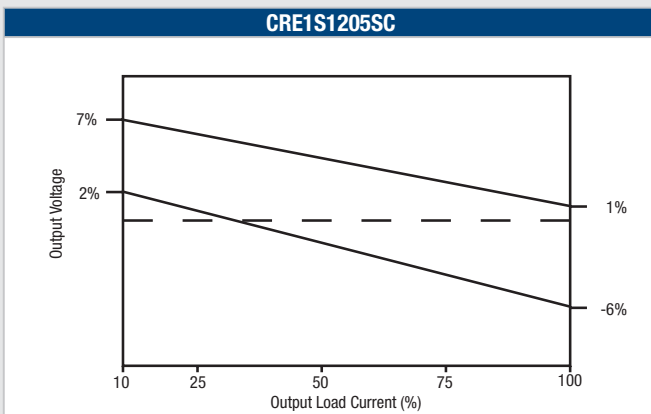
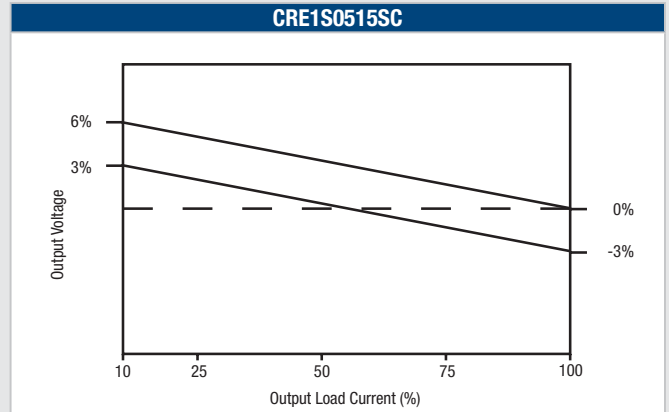
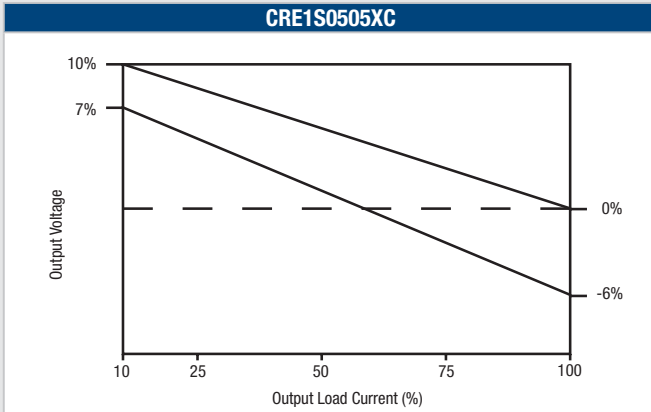

**TOLERANCE ENVELOPES (Continued)**

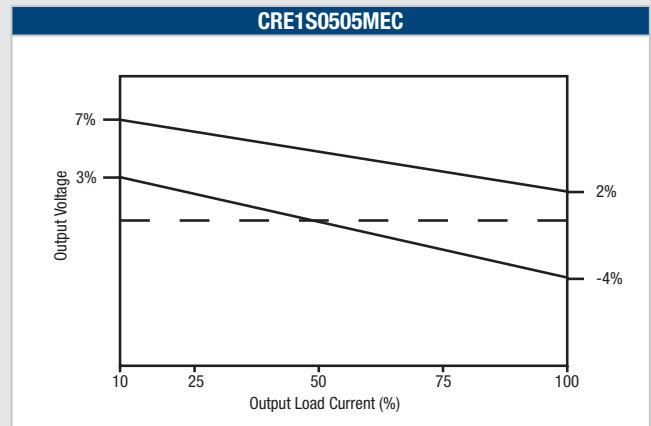
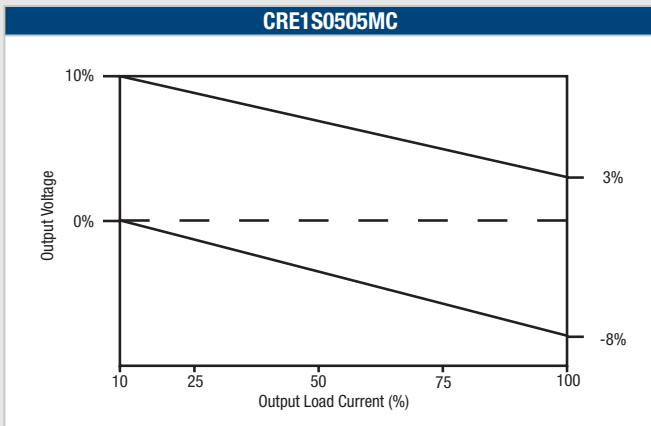
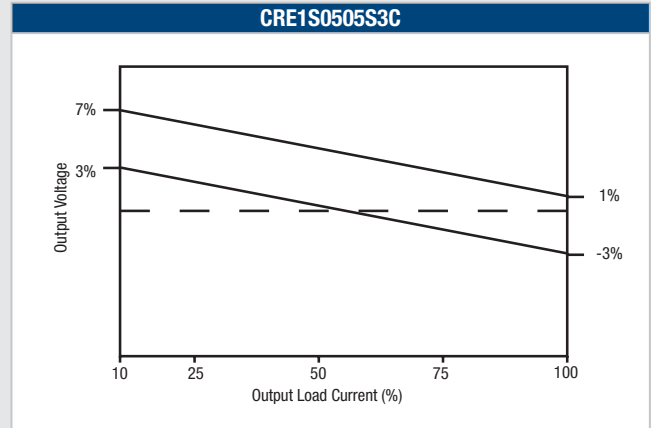
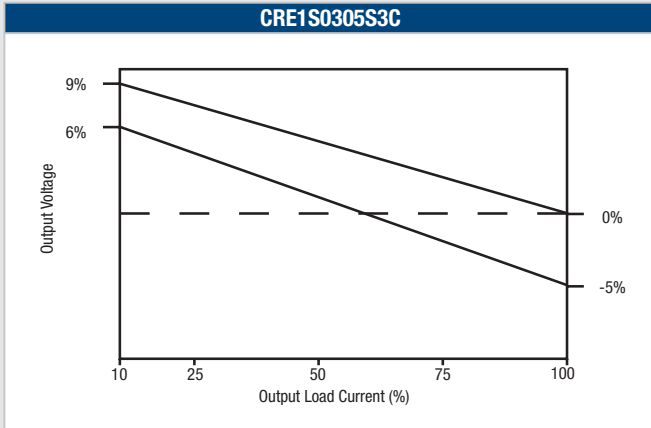

**TEMPERATURE DERATING GRAPH - Surface Mount & 3C types**

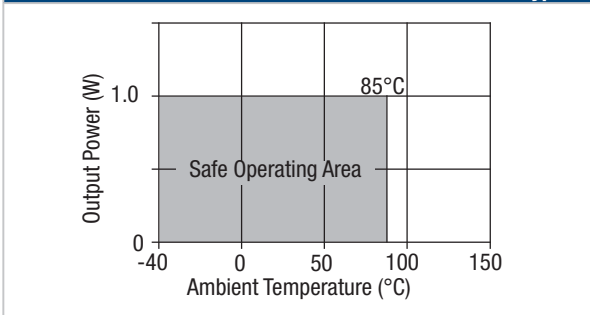

**TEMPERATURE DERATING GRAPH - All other types<sup>1</sup>**

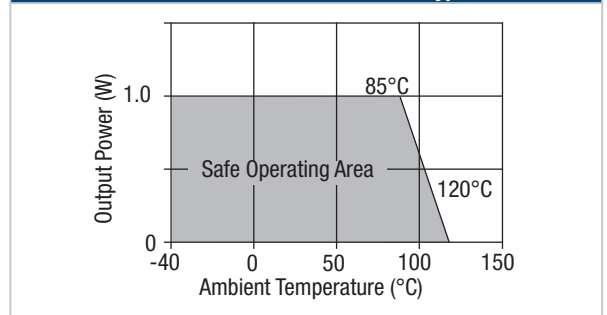

1. 24V input parts prior to date code D1635 have operating temperature range of 0 to 70°C.

## EFFICIENCY VS LOAD

### 3.3V Inputs

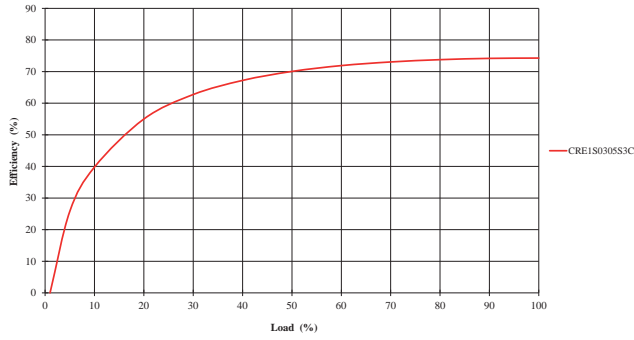

### 5V Inputs

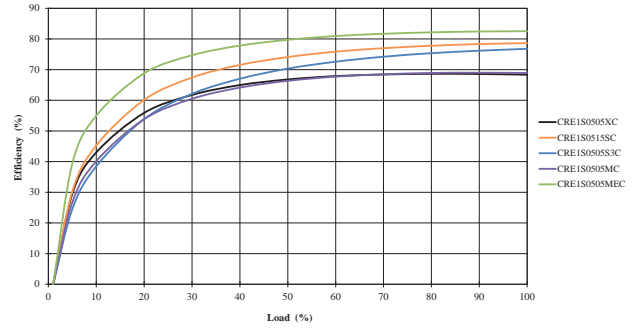

### 12V Inputs

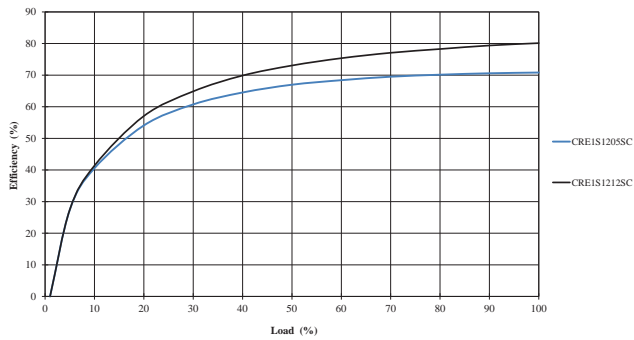

### 24V Inputs

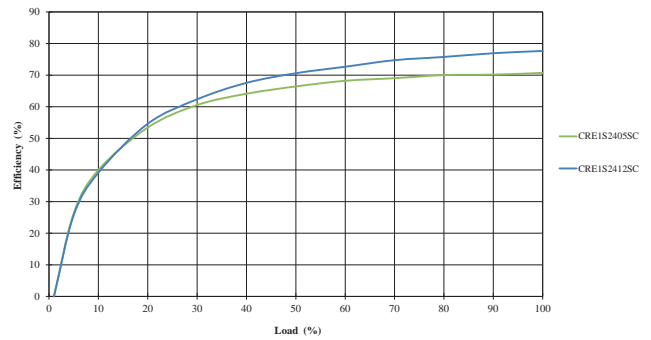

**EMC FILTERING AND SPECTRA**

**FILTERING**

The following table shows the additional input capacitor and input inductor typically required to meet EN 55022 Curve B Quasi-Peak EMC limit, as shown in the following plots. The following plots show positive and negative quasi peak and CISPR22 Average Limit B (pink line) and Quasi Peak Limit B (green line) adherence limits. The below values are for guidance only and should be evaluated in the application circuit. For the CRE1S0505MEC an input inductor is not required.

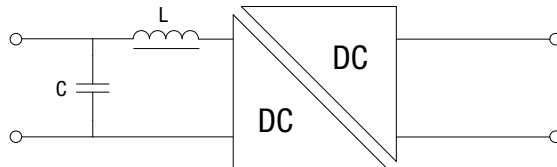

Part Number	Inductor			Capacitor		
	L, $\mu$ H	SMD	Through Hole	C, $\mu$ F	Rated Voltage	Recommended Part Number
CRE1S0505DC	4.7	82472C	13R472C	4.7	16VDC	GRM188Z71C475ME21
CRE1S0505SC	4.7	82472C	13R472C	4.7	16VDC	GRM188Z71C475ME21
CRE1S0515SC	4.7	82472C	13R472C	4.7	16VDC	GRM188Z71C475ME21
CRE1S1205SC	10	82103C	13R103C	1	50VDC	GRM21BR71H105KA12
CRE1S1212SC	10	82103C	13R103C	1	50VDC	GRM21BR71H105KA12
CRE1S2405SC	22	82223C	13R223C	10	50VDC	GRM32ER71H106MA12
CRE1S2412SC	22	82223C	13R223C	10	50VDC	GRM32ER71H106MA12
CRE1S0305S3C	10	82103C	13R103C	1	50VDC	GRM188R71C105MA12
CRE1S0505S3C	10	82103C	13R103C	1	50VDC	GRM188R71C105MA12
CRE1S0505MC	10	82103C	13R103C	4.7	16VDC	GRM188Z71C475ME21
CRE1S0505MEC	NR	NR	NR	22	10VDC	GRM32ER71A226ME20

NR - Not required

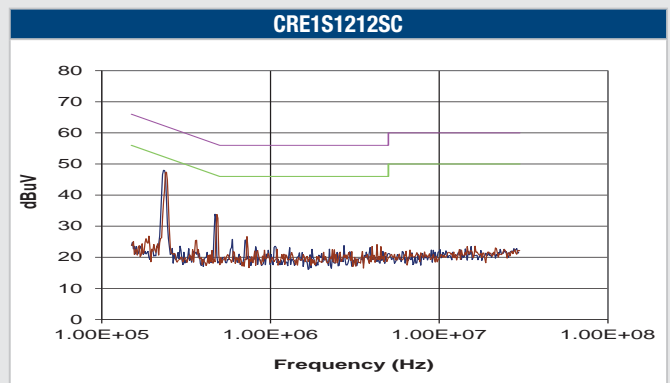
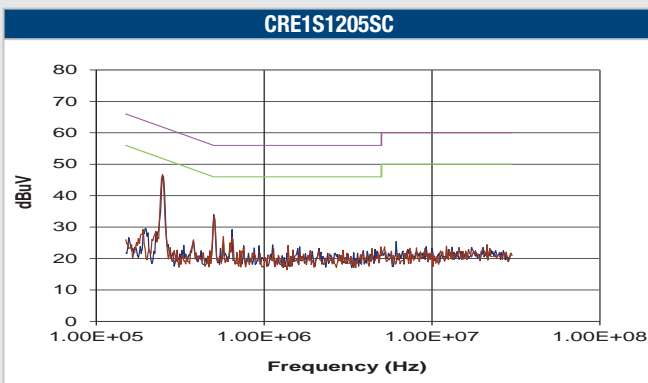
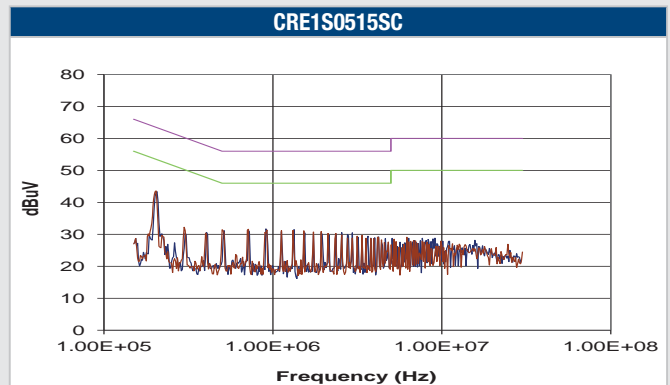
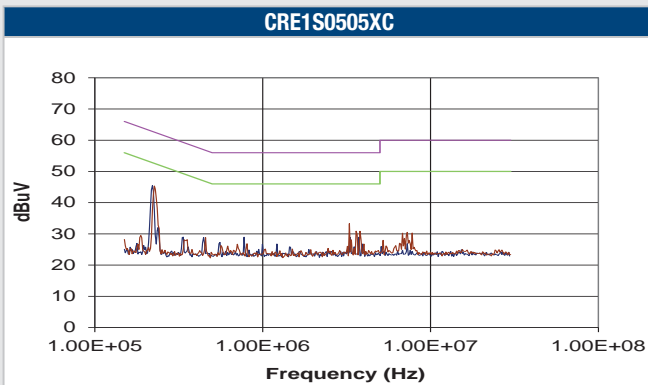

**EMC FILTERING AND SPECTRA (Continued)**

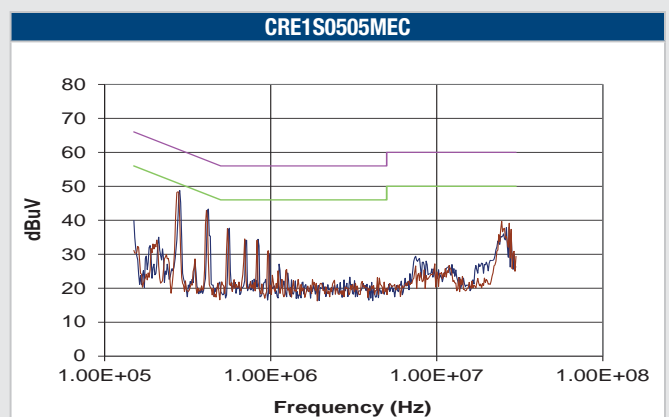
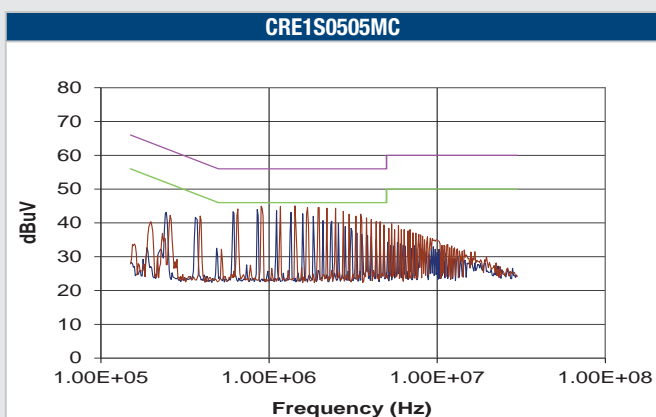
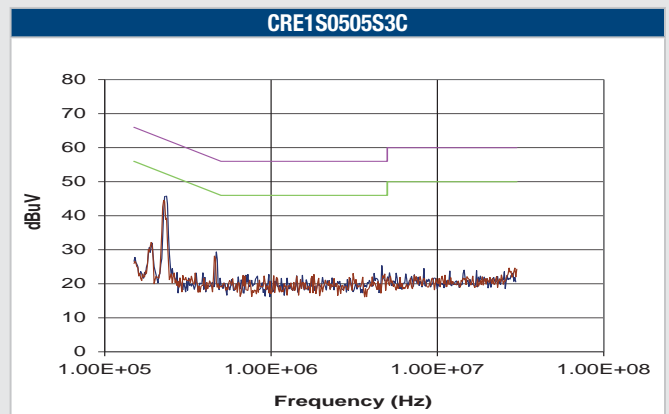
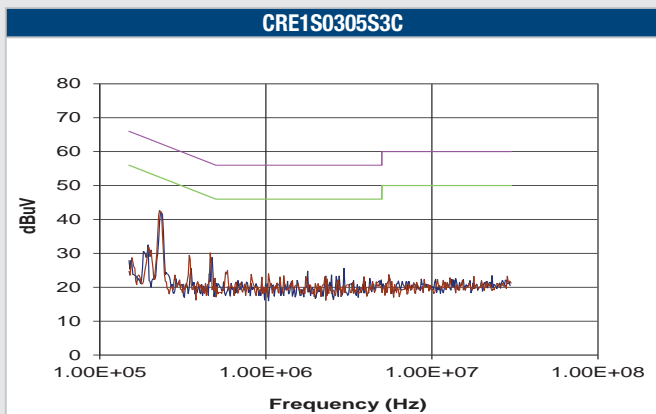
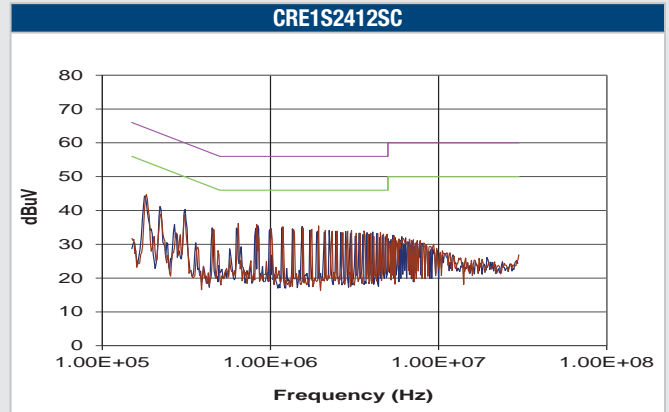
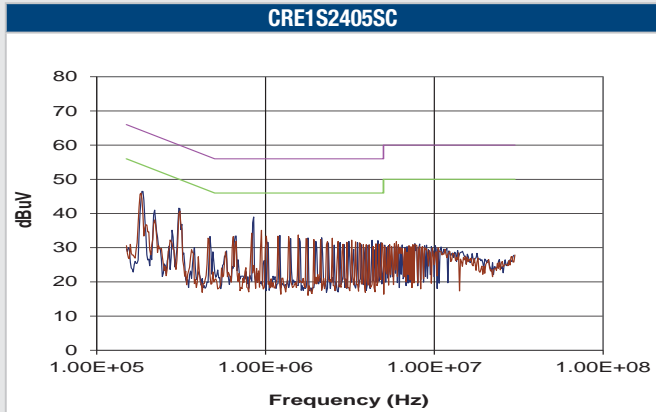

## PACKAGE SPECIFICATIONS

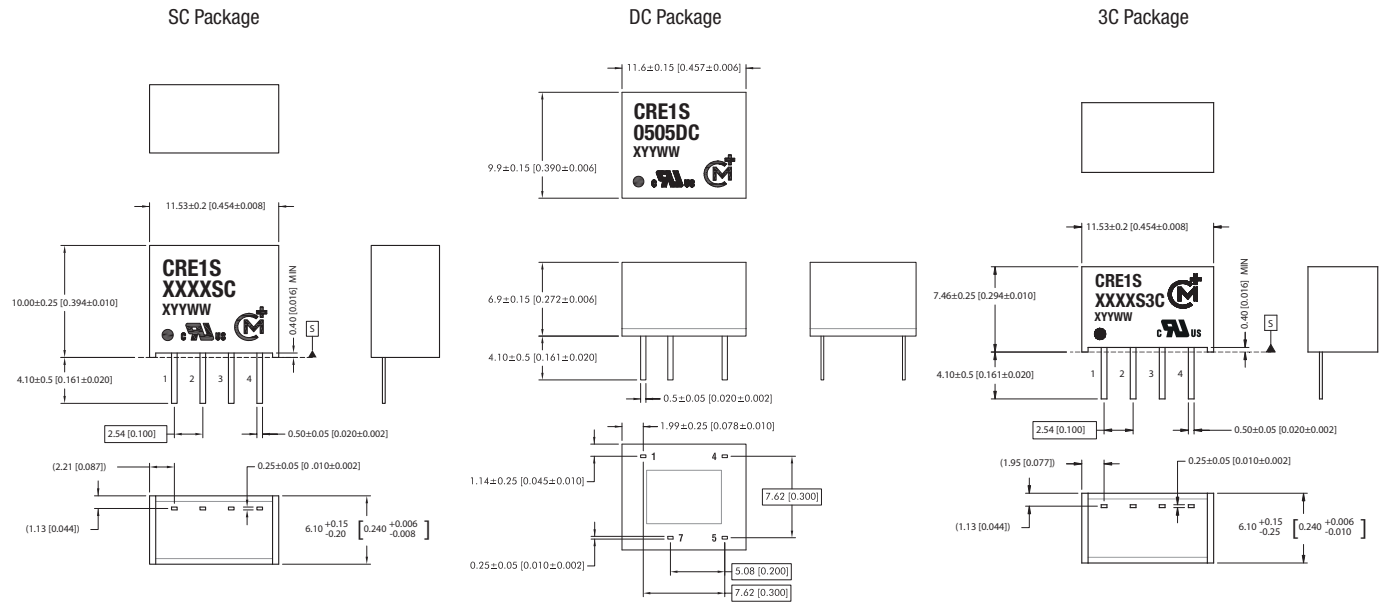

All dimensions in mm (inches) Controlling dimension is mm.

All pins on a 2.54 (0.100) pitch and within  $\pm 0.1$  (0.004) of true position from pin 1 at seating plane 'S' (SC&3C)

All pins on a 2.54 (0.100) pitch and within  $\pm 0.25$  (0.010) of true position (DC)

Weight: 1.09g (3C) 1.30g (SC) 1.38g (DC)

### PIN CONNECTIONS SC & 3C - 4 PIN SIP

Pin	Function
1	-VIN
2	+VIN
3	-VOUT
4	+VOUT

### PIN CONNECTIONS DC - 8 PIN DIP

Pin	Function
1	-VIN
4	+VIN
5	+VOUT
7	-VOUT

**PACKAGE SPECIFICATIONS (Continued)**

CRE1S0505MC

CRE1S0505MEC

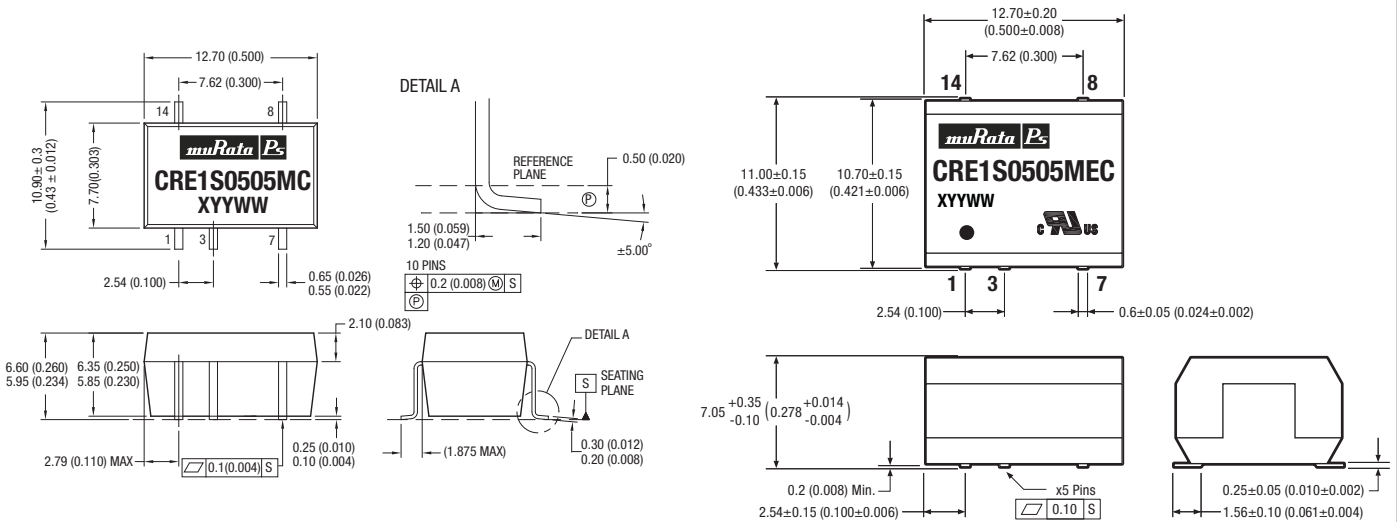

All dimensions in mm (inches) Controlling dimension is mm.

All pins on a 2.54 (0.100) pitch and within ±0.25 (0.010) of true position

**PIN CONNECTIONS - CRE1SXXXXMC/MEC**

Pin	Function
1	-VIN
3	+VIN
7	-VOUT
8	+VOUT
14	NA

Weight: 1.2g

**PACKAGE SPECIFICATIONS (Continued)**

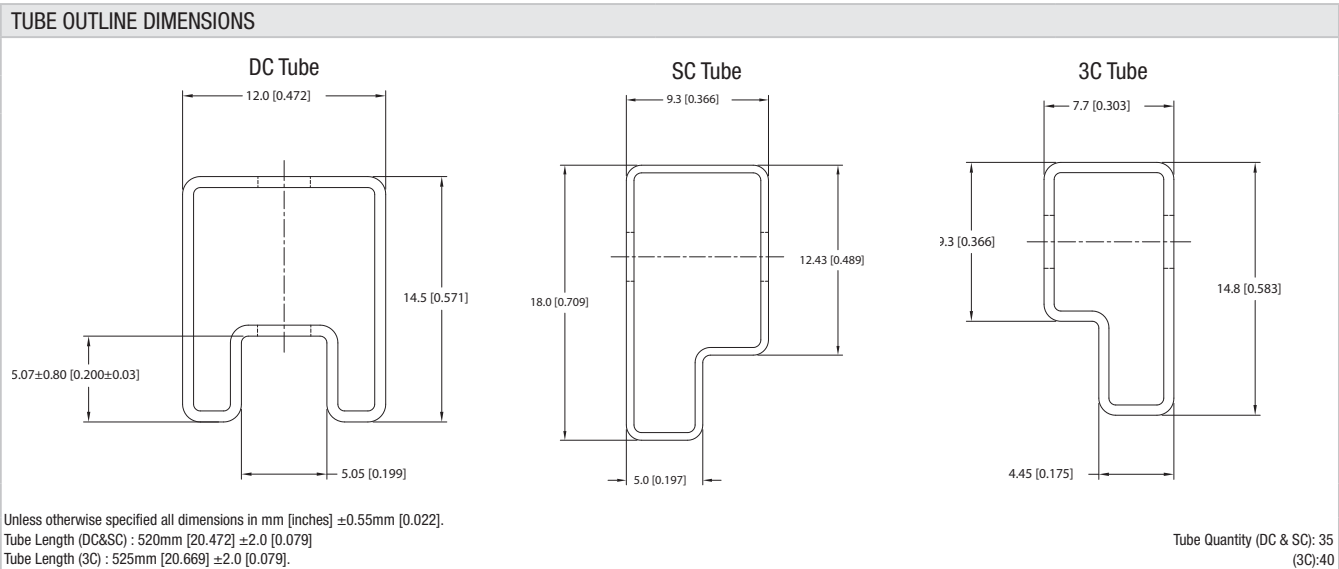
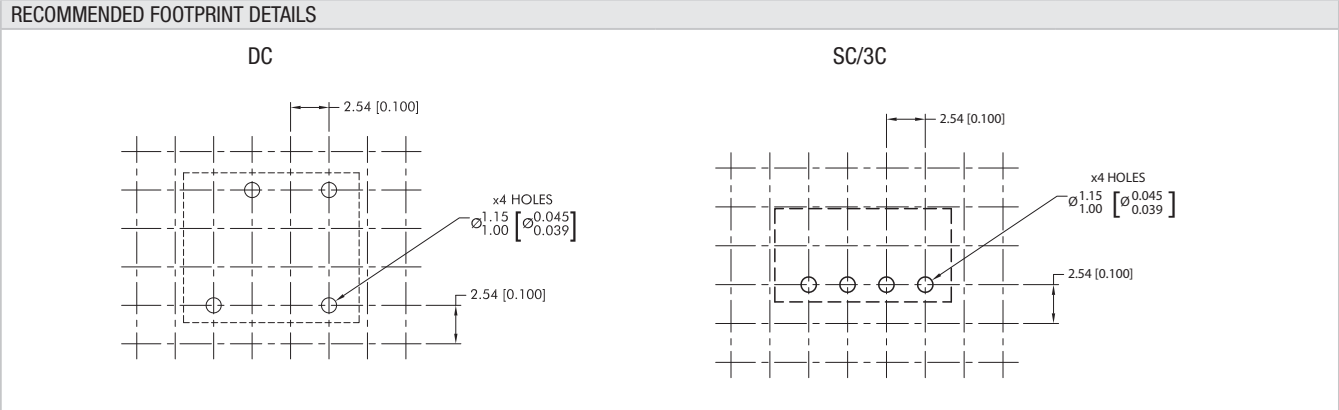

**PACKAGE SPECIFICATIONS (Continued)**

**RECOMMENDED FOOTPRINT DETAILS**

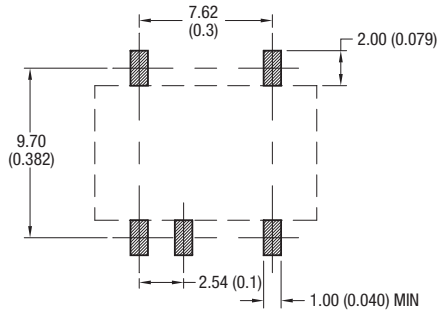

**TUBE OUTLINE DIMENSIONS**

CRE1S0505MC

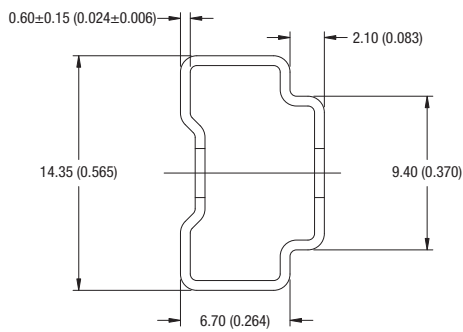

CRE1S0505MEC

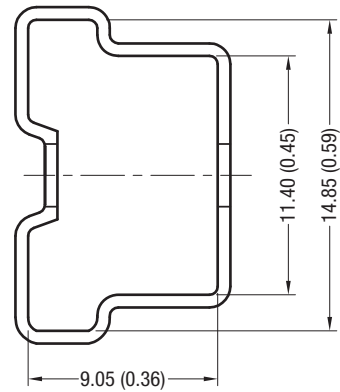

Unless otherwise specified all dimensions in mm [inches]  $\pm 0.55\text{mm}$  [0.022].  
 Tube Length (MC&MEC) :  $475 \pm 2.0$  (18.70  $\pm 0.07$ ).

Tube Quantity (MC): 35  
 (MEC): 30

**TAPE & REEL SPECIFICATIONS**

**REEL OUTLINE DIMENSIONS**

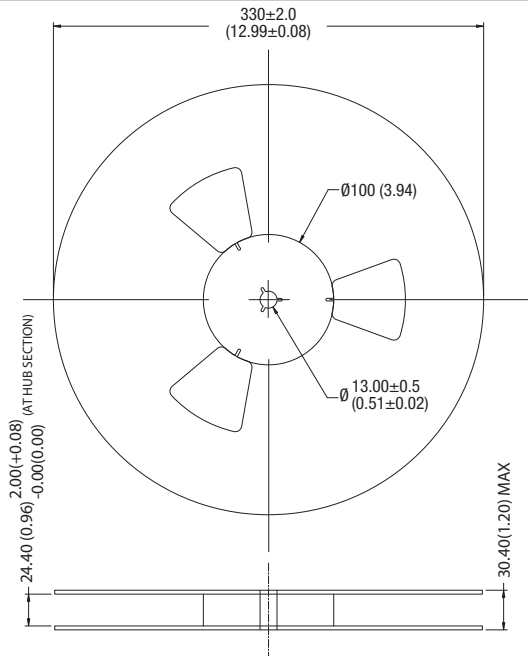

**TAPE OUTLINE DIMENSIONS**

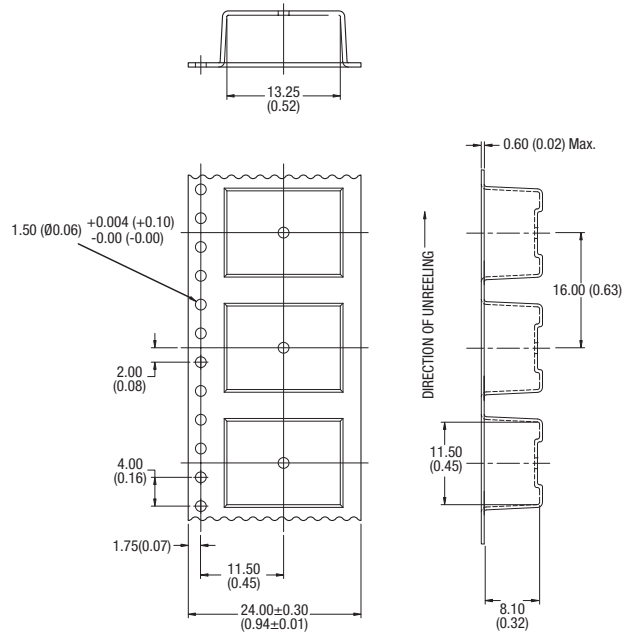

**REEL PACKAGING DETAILS**

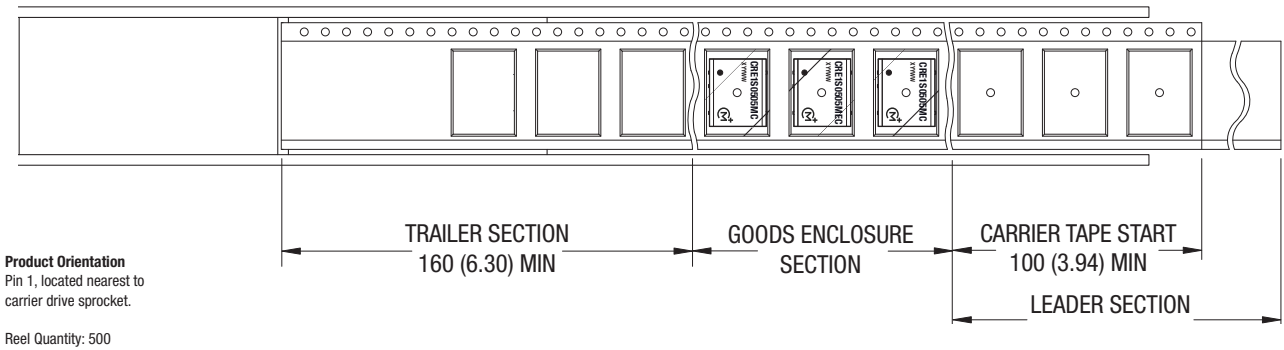

**DISCLAIMER**

Unless otherwise stated in the datasheet, all products are designed for standard commercial and industrial applications and NOT for safety-critical and/or life-critical applications.

Particularly for safety-critical and/or life-critical applications, i.e. applications that may directly endanger or cause the loss of life, inflict bodily harm and/or loss or severe damage to equipment/property, and severely harm the environment, a prior explicit written approval from Murata is strictly required. Any use of Murata standard products for any safety-critical, life-critical or any related applications without any prior explicit written approval from Murata shall be deemed unauthorised use.

These applications include but are not limited to:

- Aircraft equipment
- Aerospace equipment
- Undersea equipment
- Power plant control equipment
- Medical equipment
- Transportation equipment ( automobiles, trains, ships, etc.)
- Traffic signal equipment
- Disaster prevention / crime prevention equipment
- Data Processing equipment

Murata makes no express or implied warranty, representation, or guarantee of suitability, fitness for any particular use/purpose and/or compatibility with any application or device of the buyer, nor does Murata assume any liability whatsoever arising out of unauthorised use of any Murata product for the application of the buyer. The suitability, fitness for any particular use/purpose and/or compatibility of Murata product with any application or device of the buyer remain to be the responsibility and liability of the buyer.

Buyer represents and agrees that it has all the necessary expertise to create and implement safeguards that anticipate dangerous consequences of failures, monitor failures and their consequences, lessen the likelihood of failures that might cause harm, and take appropriate remedial actions. Buyer will fully indemnify and hold Murata, its affiliated companies, and its representatives harmless against any damages arising out of unauthorised use of any Murata products in any safety-critical and/or life-critical applications.

Remark: Murata in this section refers to Murata Manufacturing Company and its affiliated companies worldwide including, but not limited to, Murata Power Solutions.



This product is subject to the following [operating requirements](#) and the [Life and Safety Critical Application Sales Policy](#):



Refer to: <https://www.murata.com/en-eu/products/power/requirements>

Murata Power Solutions (Milton Keynes) Ltd. makes no representation that the use of its products in the circuits described herein, or the use of other technical information contained herein, will not infringe upon existing or future patent rights. The descriptions contained herein do not imply the granting of licenses to make, use, or sell equipment constructed in accordance therewith. Specifications are subject to change without notice.

© 2024 Murata Power Solutions (Milton Keynes) Ltd.

## Looking for pricing, stock, or lifecycle information?

Click below to explore more details on WIN SOURCE:

-  [View CRE1S1212SC on WIN SOURCE](#)
-  [Murata Power Solutions Inc. Information](#)

## Optimize Your Supply Chain with WIN SOURCE Solutions

-  Global Sourcing Solution
-  Obsolete Management
-  Cost Control Management
-  Shortage Management
-  Alternative Solution
-  Excess Inventory Management