

R-78K-0.5 series \diamond Switching Regulator

0.5Amp \diamond Single Output \diamond SIP3

FEATURES

- Efficiency up to 96%, no need for heat-sinks
- 4.5-36VDC wide input voltage
- -40°C to +90°C ambient operation without derating
- Pin compatible with 78 series regulators
- Non isolated DC/DC converter
- Undervoltage and short circuit protection
- 3 year warranty



Dimensions (LxWxH): 11.5 x 7.55 x 10.2mm (0.45 x 0.30 x 0.40 inch)
1.7g (0.038 lbs)

APPLICATIONS

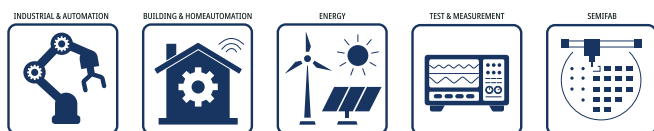

SAFETY & EMC



DESCRIPTION

The R-78K-0.5 series is a switching regulator module that has been designed to offer all the advantages of a switching regulator (high efficiency, wide input range, accurate output voltage regulation) but with a low cost for production quantities. Due to the R-78K-0.5's high efficiency of up to 96%, no heat-sink is required, and full load operation from -40 to 90°C is possible. The compact TO-220 compatible SIP3 package measures only 11.5 x 7.55 x 10.2mm, so it saves precious board space.

SELECTION GUIDE

Part Number	Input Voltage Range [VDC]	Output Voltage nom. [VDC]	Output Current max. [mA]	Efficiency	
				@ min. Vin [%]	@ max. Vin [%]
R-78K1.5-0.5	4.5-36	1.5	500	83	66
R-78K1.8-0.5	4.5-36	1.8	500	85	70
R-78K2.5-0.5	4.5-36	2.5	500	87	75
R-78K3.3-0.5	4.5-36	3.3	500	89	80
R-78K5.0-0.5	6.5-36	5	500	92	85
R-78K6.5-0.5	8-36	6.5	500	93	86
R-78K9.0-0.5	12-36	9	500	94	89
R-78K12-0.5	15-36	12	500	95	91
R-78K15-0.5	18-36	15	500	96	92

R-78K-0.5 series \diamond Switching Regulator

0.5Amp \diamond Single Output \diamond SIP3

MODEL NUMBERING

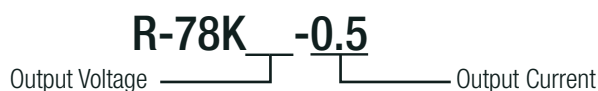

ABSOLUTE MAX. RATINGS (exceeding these ratings may damage the device)

Parameters	Condition	Min.	Typ.	Max.
Maximum Input Voltage Slew Rate ⁽¹⁾	+V _{IN} to GND			10VDC/ μ s
Case Temperature		-40°C		115°C

Note1: At higher slew rates or hard plugging, add 27 μ F E-Cap between +Vin and GND, especially when Vin is >18VDC

BASIC CHARACTERISTICS (measured @ T_{AMB}= 25°C, nom. V_{IN}, full load and after warm-up unless otherwise stated)

Parameter	Condition		Min.	Typ.	Max.	
Input Under Voltage Lockout (UVLO)	R-78K1.5-0.5, R-78K1.8-0.5, R-78K2.5-0.5, R-78K3.3-0.5	DC-DC ON	4VDC		4.3VDC	
		DC-DC OFF	3.6VDC		3.9VDC	
	R-78K5.0-0.5	DC-DC ON	5.15VDC		5.45VDC	
		DC-DC OFF	4.6VDC		4.9VDC	
	R-78K6.5-0.5	DC-DC ON	7VDC		7.5VDC	
		DC-DC OFF	6.3VDC		6.7VDC	
	R-78K9.0-0.5	DC-DC ON	10.2VDC		10.8VDC	
		DC-DC OFF	9.1VDC		9.7VDC	
	R-78K12-0.5	DC-DC ON	13.8VDC		14.4VDC	
		DC-DC OFF	12.4VDC		13VDC	
	R-78K15-0.5	DC-DC ON	16.9VDC		17.5VDC	
		DC-DC OFF	15.2VDC		15.8VDC	
	Quiescent Current					1mA
	Internal Operating Frequency			600kHz	700kHz	800kHz
Minimum Load			0%			
Output Ripple and Noise ⁽²⁾	20MHz BW	R-78K1.5-0.5 - R-78K1.8-0.5		30mVp-p		
		R-78K2.5-0.5 - R-78K3.3-0.5		60mVp-p		
		R-78K5.0-0.5 - R-78K6.5-0.5		85mVp-p		
		R-78K9.0-0.5 - R-78K15-0.5		100mVp-p		

Note2: The test setup can have an impact on ripple noise values (placement of scope probe, capacitors, it's specifications, wires, PCB tracks, distances, etc.)

R-78K1.5-0.5

Efficiency vs. Output Load

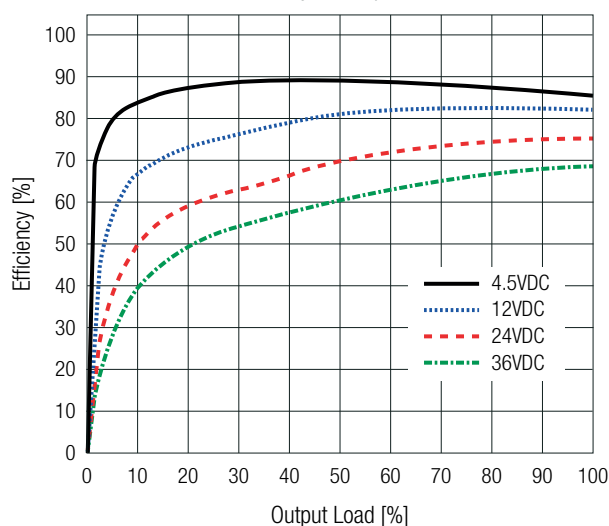

Power Dissipation vs. Output Load

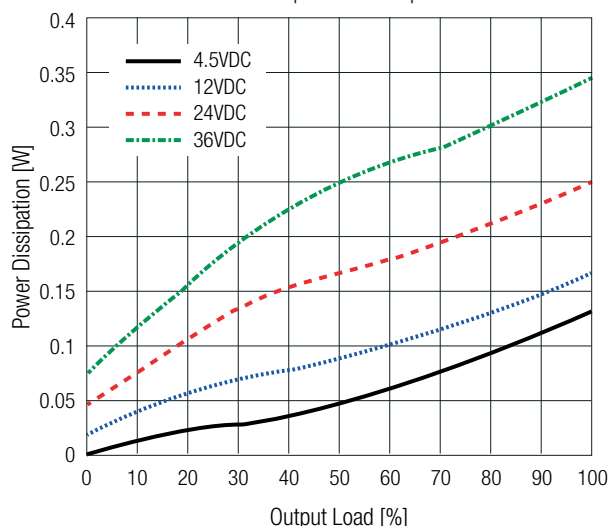

R-78K-0.5 series \diamond Switching Regulator

0.5Amp \diamond Single Output \diamond SIP3

BASIC CHARACTERISTICS (measured @ $T_{AMB}=25^{\circ}C$, nom. V_{IN} , full load and after warm-up unless otherwise stated)

R-78K1.8-0.5

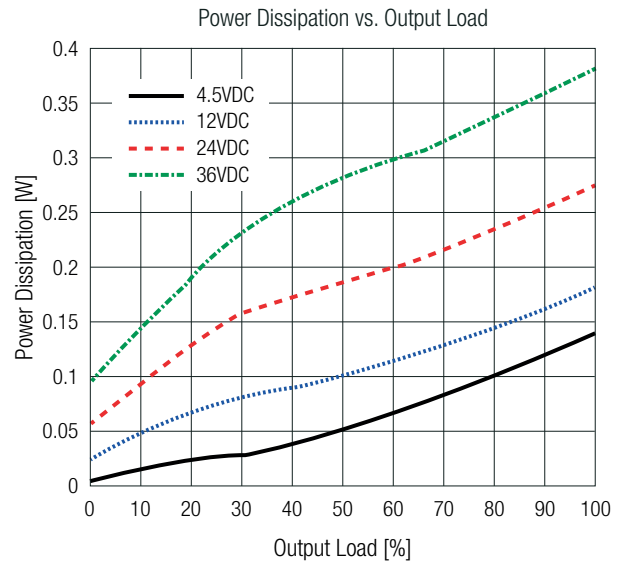
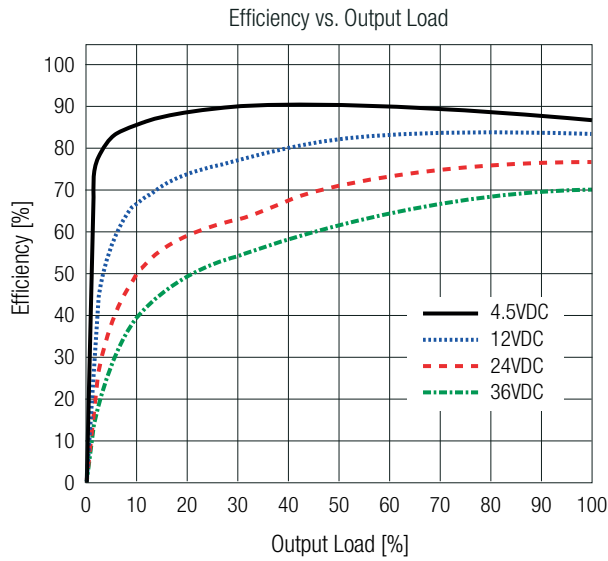

R-78K2.5-0.5

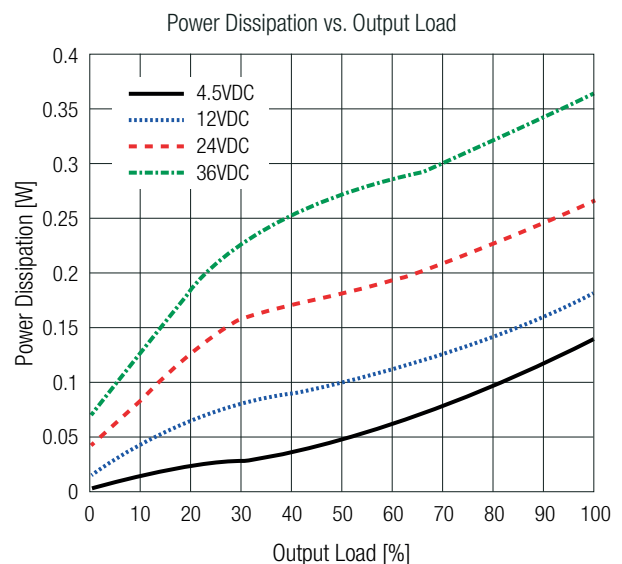
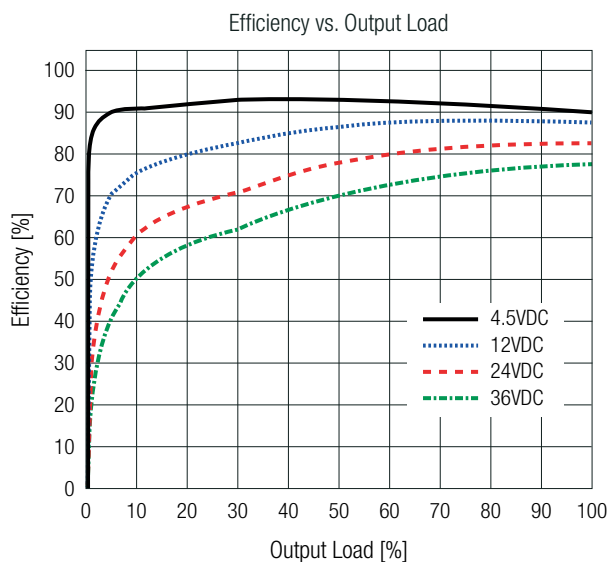

R-78K3.3-0.5

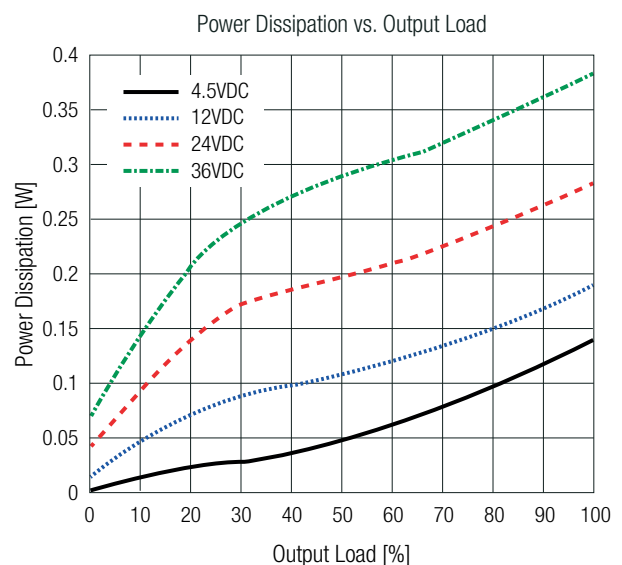
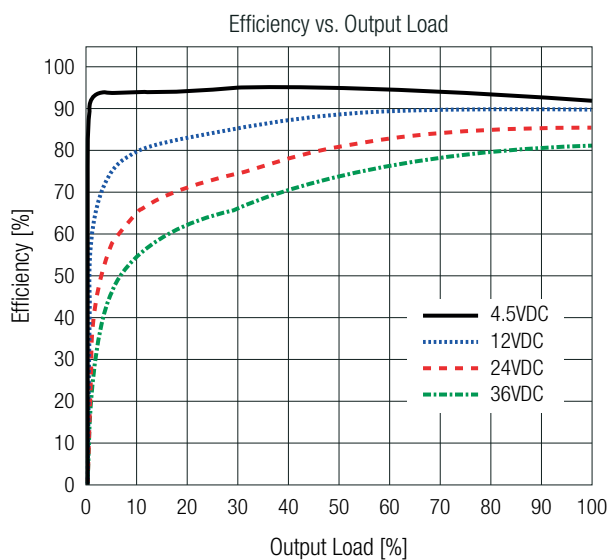

R-78K-0.5 series \diamond Switching Regulator

0.5Amp \diamond Single Output \diamond SIP3

BASIC CHARACTERISTICS (measured @ $T_{AMB} = 25^{\circ}\text{C}$, nom. V_{IN} , full load and after warm-up unless otherwise stated)

R-78K5.0-0.5

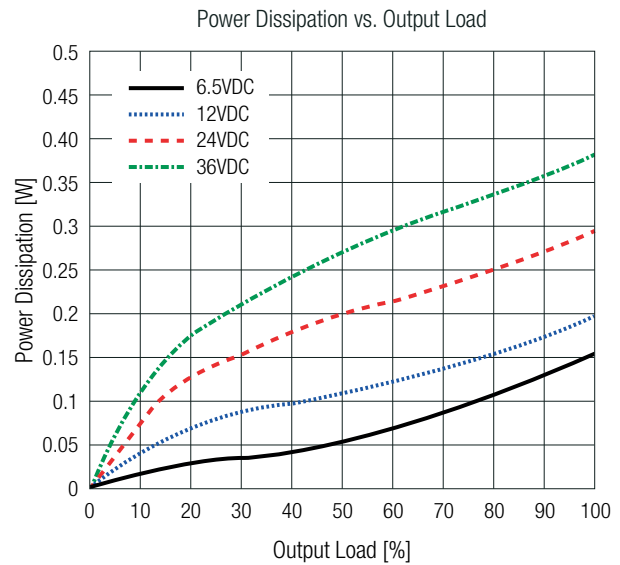
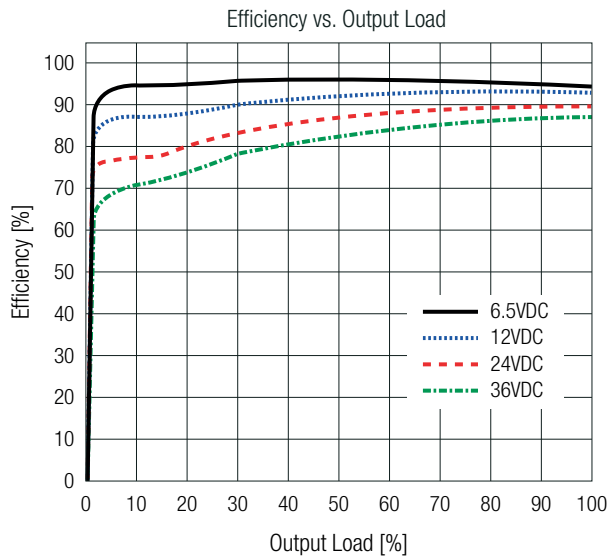

R-78K6.5-0.5

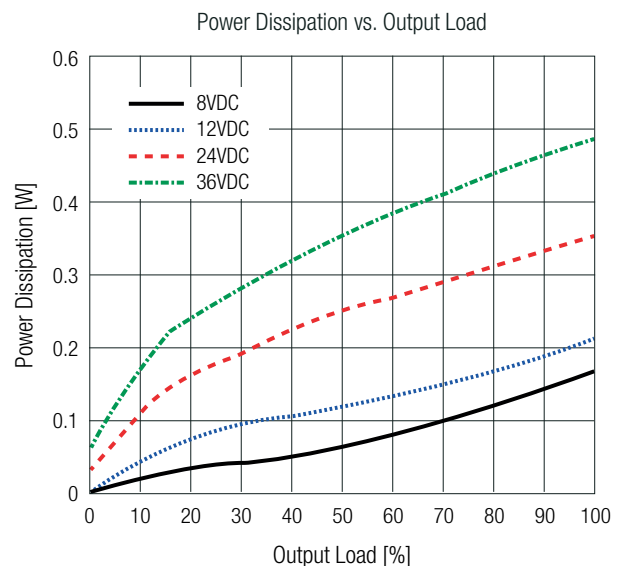
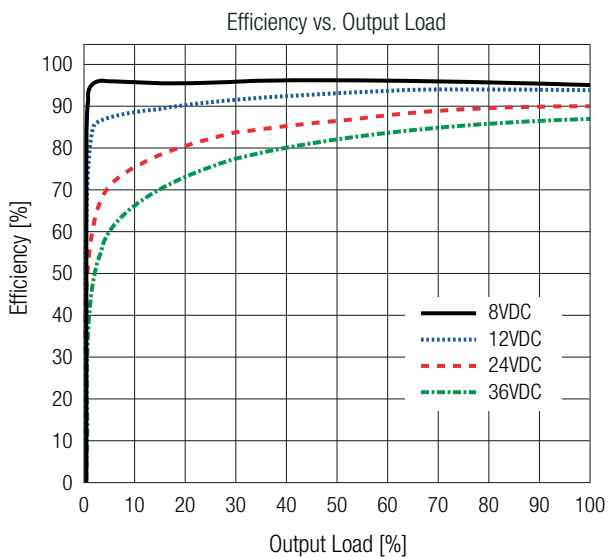

R-78K9.0-0.5

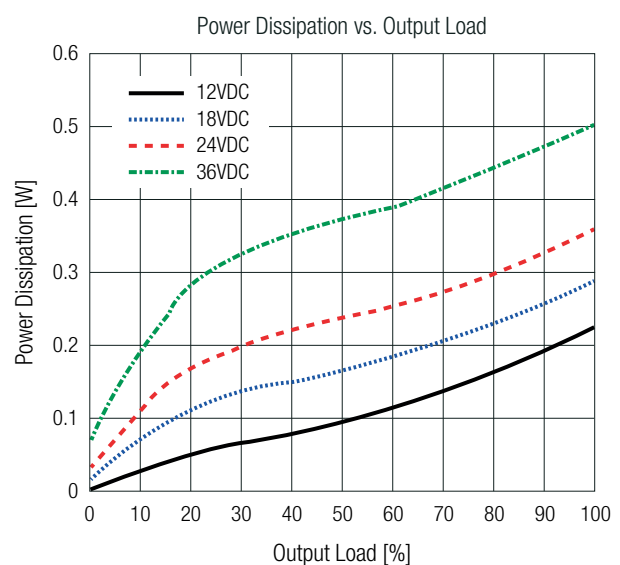
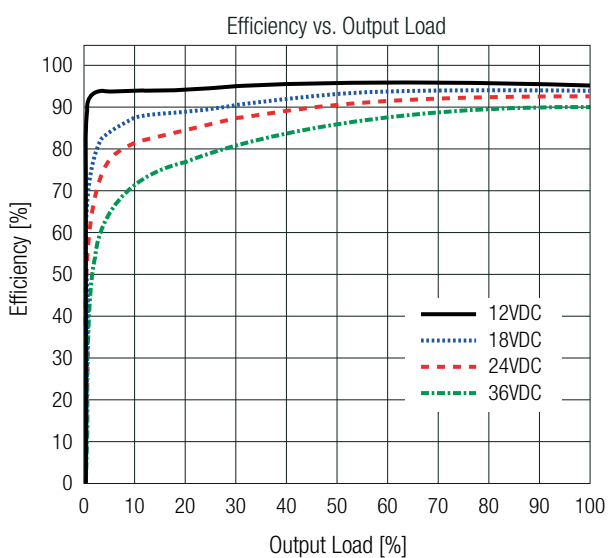

R-78K-0.5 series \diamond Switching Regulator

0.5Amp \diamond Single Output \diamond SIP3

BASIC CHARACTERISTICS (measured @ $T_{AMB} = 25^{\circ}\text{C}$, nom. V_{IN} , full load and after warm-up unless otherwise stated)

R-78K12-0.5

Efficiency vs. Output Load

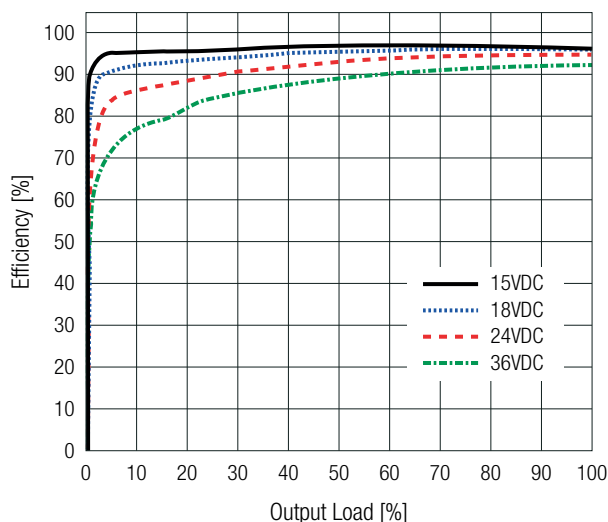

Power Dissipation vs. Output Load

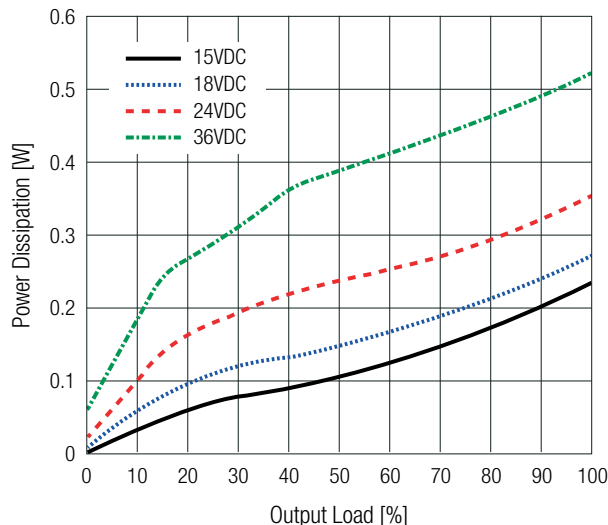

R-78K15-0.5

Efficiency vs. Output Load

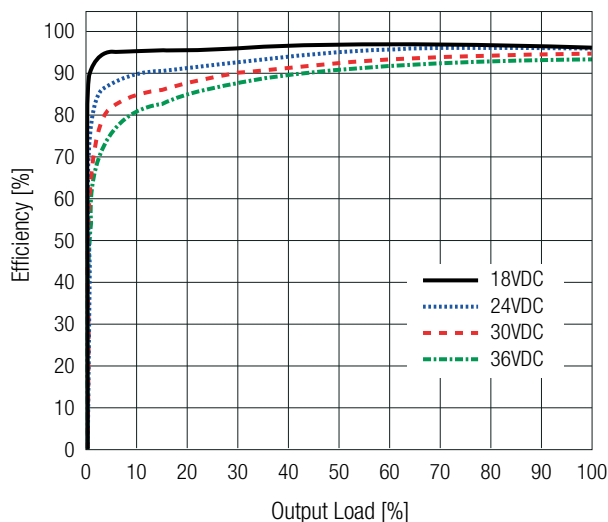

Power Dissipation vs. Output Load

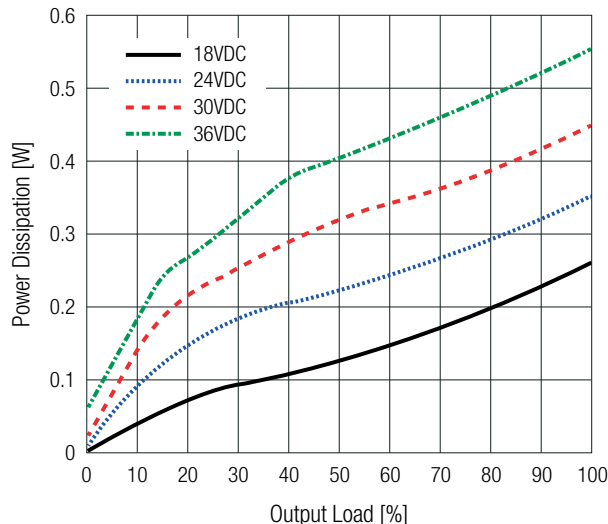

REGULATIONS

Parameter	Condition	Value
Output Accuracy		$\pm 1.7\%$ typ. / $\pm 2.7\%$ max.
Line Regulation	low line to high line, full load	$\pm 0.3\%$ max.
Load Regulation	0% to 100%	1.7% typ. / 2.7% max.
	10% to 100% load	1.5% max.

PROTECTIONS

Parameter	Condition	Value
Short Circuit Protection (SCP)		continuous, automatic recovery
Short Circuit Input Current		30mA max.

Optional Diode Protection Circuit

Add a blocking diode to V_{out} if current can flow backwards into the output, as this can damage the converter when it is powered down.

The diode can either be fitted across the device if the source is low impedance or fitted in series with the output (recommended).

Optional Protection 1:

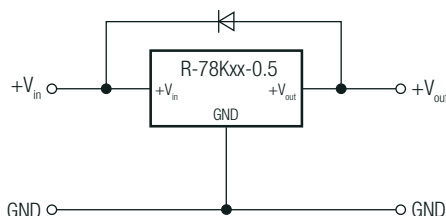

Optional Protection 2:

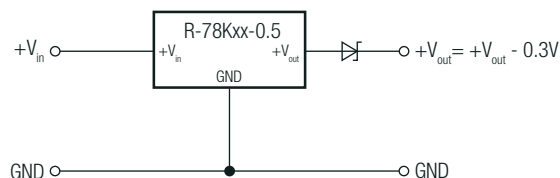

R-78K-0.5 series \diamond Switching Regulator

0.5Amp \diamond Single Output \diamond SIP3

ENVIRONMENTAL

Parameter	Condition	Value	
Operating Temperature Range	refer to "Derating Graph"	-40°C to +90°C	
Maximum Case Temperature		+115°C	
Temperature Coefficient		0.01%/K	
Operating Altitude ⁽³⁾		5000m max.	
Operating Humidity	non-condensing	95% RH max.	
Vibration		10-55Hz, 2G, 30min along X,Y and Z axis	
MTBF	according to MIL-HDBK-217F, G.B., +25°C	R-78K1.5-0.5	7517 x 10 ³ hours
		R-78K1.8-0.5	6644 x 10 ³ hours
		R-78K2.5-0.5	7538 x 10 ³ hours
		R-78K3.3-0.5	6762 x 10 ³ hours
		R-78K5.0-0.5	9861 x 10 ³ hours
		R-78K6.5-0.5, R-78K9.0-0.5	3361 x 10 ³ hours
		R-78K12-0.5	4523 x 10 ³ hours
		R-78K15-0.5	3485 x 10 ³ hours

Note3: For altitude higher than 2000m, 5% power derating for every 1000m

Derating Graph

(@ Chamber and natural convection 0.1m/s)

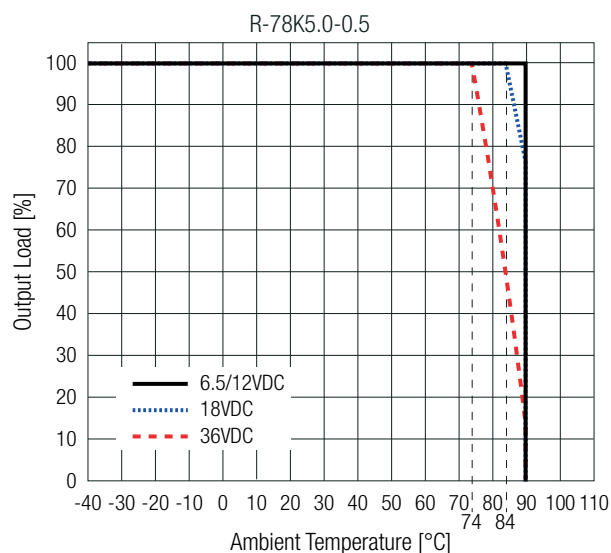
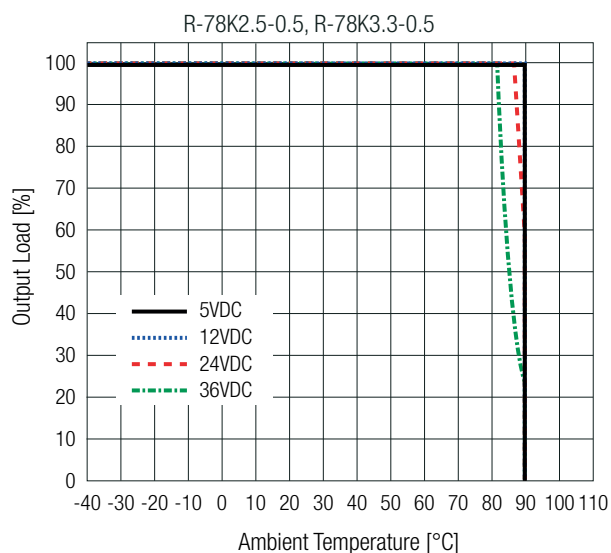
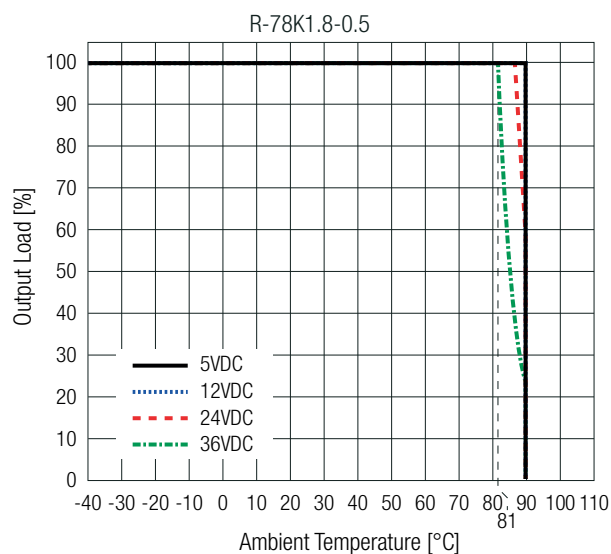
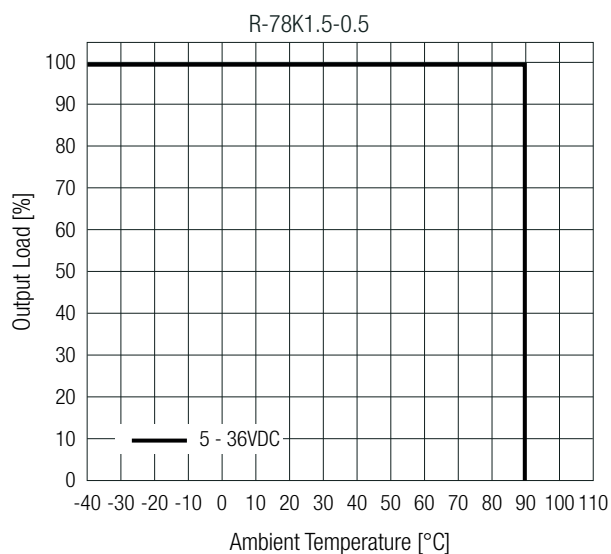

R-78K-0.5 series \diamond Switching Regulator

0.5Amp \diamond Single Output \diamond SIP3

ENVIRONMENTAL

Derating Graph

(@ Chamber and natural convection 0.1m/s)

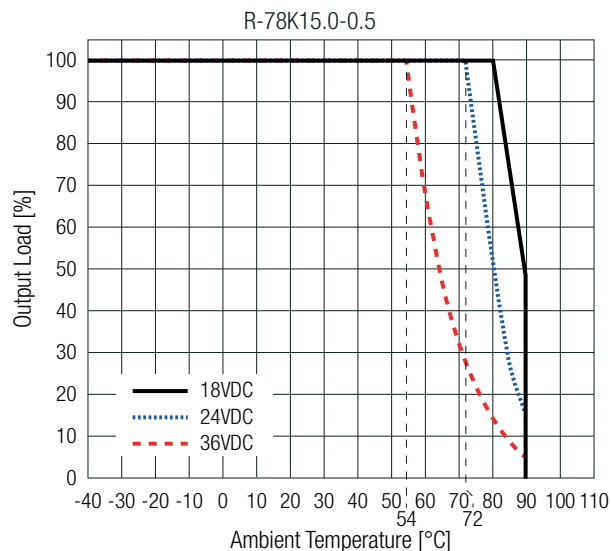
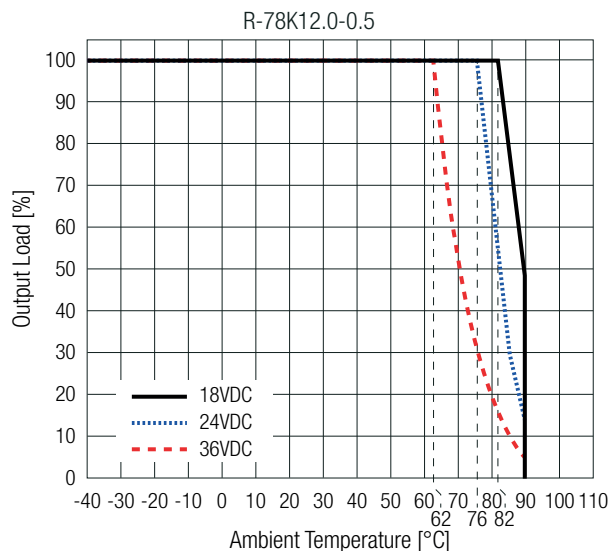
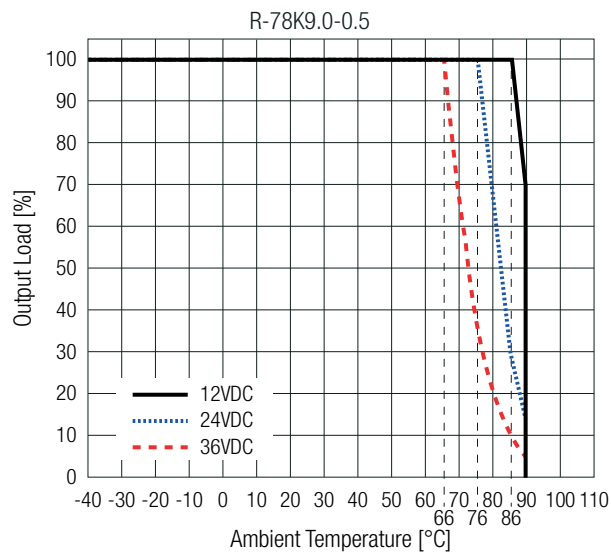
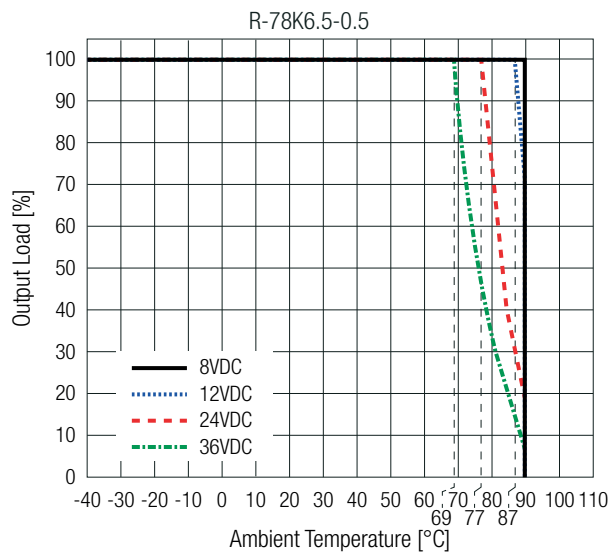

SAFETY AND CERTIFICATIONS

Certificate Type (Safety)	Report Number	Standard
Audio/Video, information and communication technology equipment - Part 1: Safety requirements	pending	IEC62368-1:2018 3rd Edition
RoHS2		RoHS 2011/65/EU + AM2015/863
EMC Compliance	Condition	Standard /Criterion
Electromagnetic compatibility of multimedia equipment - Emission requirements	with external filter refer to „EMC Filtering“	EN55032, Class B

EMC Filtering Suggestions according to EN55032

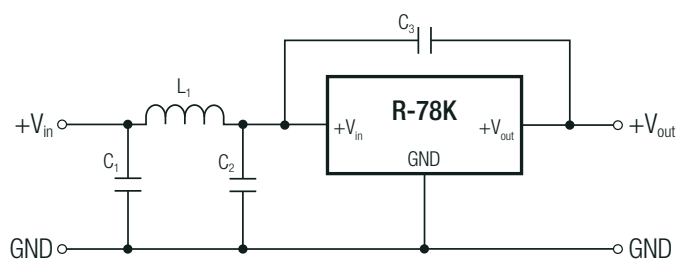

Component List Class B

L1	C1 /C2	C3
100 μ H	10 μ F	1nF

R-78K-0.5 series \diamond Switching Regulator

0.5Amp \diamond Single Output \diamond SIP3

DIMENSION & PHYSICAL CHARACTERISTICS

Parameter	Type	Value
Materials	case	black plastic, (UL94 V-0)
	potting	PU, (UL94 V-0)
	PCB	FR4, (UL94 V-0)
Dimension (LxWxH)		11.5 x 7.55 x 10.2mm 0.45 x 0.30 x 0.40 inch
Weight		1.7g typ. 0.038 lbs

DIMENSION & PHYSICAL CHARACTERISTICS

Dimension Drawing

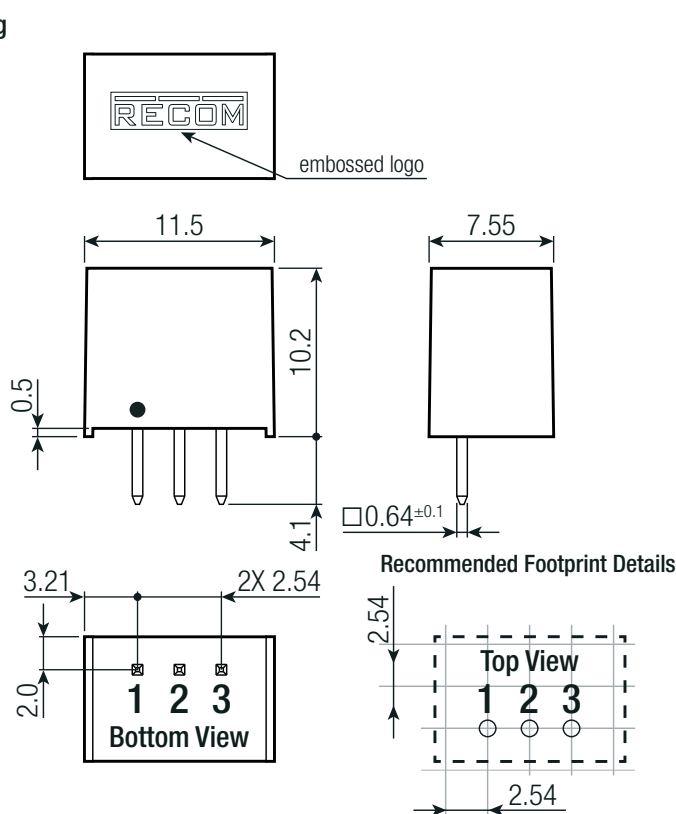

Pinning information

Pin #	Single
1	+V _{IN}
2	GND
3	+V _{OUT}

Recommended Footprint Details

Tolerances:
x.x= ±0.5mm
x.xx= ±0.25mm



PACKAGING INFORMATION

Parameter	Type	Value
Packaging Dimension (LxWxH)	tube	520.0 x 9.2 x 19.0mm
Packaging Quantity		43pcs
Storage Temperature Range		-50°C to +125°C
Storage Humidity	non-condensing	95% RH max.

The product information and specifications may be subject to changes even without prior written notice. The product has been designed for various applications; its suitability lies in the responsibility of each customer. The products are not authorized for use in safety-critical applications without RECOM's explicit written consent. A safety-critical application is an application where a failure may reasonably be expected to endanger or cause loss of life, inflict bodily harm or damage property. The applicant shall indemnify and hold harmless RECOM, its affiliated companies and its representatives against any damage claims in connection with the unauthorized use of RECOM products in such safety-critical applications.

Looking for pricing, stock, or lifecycle information?

Click below to explore more details on WIN SOURCE:

-  [View R-78K12-0.5 on WIN SOURCE](#)
-  [Recom Power Information](#)

Optimize Your Supply Chain with WIN SOURCE Solutions

-  Global Sourcing Solution
-  Obsolete Management
-  Cost Control Management
-  Shortage Management
-  Alternative Solution
-  Excess Inventory Management