



THE DATASHEET OF CRM-9S



CRM-9S | Multifunction time relay - solid state output



- Multifunction time relay for universal use in automation, control and regulation or in house installations
- Universal supply voltage AC/DC 12 – 240 V
- Noiseless switching output
- Comfortable and well-arranged function and time-range setting by rotary switches.
- Time scale 0.1 s - 10 days divided into 10 ranges: (0.1 s - 1 s / 1 s - 10 s / 0.1 min - 1 min / 1 min - 10 min / 0.1 hrs - 1 h / 1 h - 10 hrs / 0.1 day - 1 day / 1 day - 10 days / only ON / only OFF)
- Output contact: 1× static contactless output (triac) 1.5 A, switches potential A1
- Multifunction red LED flashes or shines depending on the operating states

EAN code
CRM-9S: 8595188116008

Technical parameters		CRM-9S
Power supply		
Supply terminals:	A1-A2	
Supply voltage*:	AC/DC 12 – 240 V (AC 50-60 Hz)	
Consumption (max.):	3 VA/0.7 W	
Supply voltage tolerance:	-15 %; +10 %	
Time circuit		
Number of functions:	10	
Time ranges:	0.1 s – 10 days	
Time setting:	rotary switch and potentiometer	
Time deviation:	5 % – mechanical setting	
Repeat accuracy:	0.2 % – set value stability	
Temperature coefficient:	0.01 %/°C, at = 20 °C (0.01 %/°F, at = 68 °F)	
Output		
Contact type:	1× static contactless output (triac)	
Current rating:	1.5 A/AC1	
Breaking capacity:	375 VA/AC1	
Inrush current:	60 A/< 10 ms	
Switching voltage:	250 V AC	
Power dissipation (max.):	1.4 W	
Voltage drop across switch:	max. 0.9 V/Imax.	
Load to terminal B1:	Yes/Imax. 1.5 A	
Electrical lifetime (AC1):	100.000.000 ops.	
Control		
Control terminals:	A1-S	
Load between S-A2:	Yes	
Impulse length:	min. 25 ms/max. unlimited	
Reset time:	max. 150 ms	
Other information		
Operating temperature:	-20 .. +55 °C	
Storage temperature:	-30 .. +70 °C	
Operating position:	any	
Mounting:	DIN rail EN 60715	
Protection degree:	IP40 front panel/IP20 terminals	
Overvoltage category:	III.	
Pollution degree:	2	
Cross-wire section – solid/ stranded with ferrule (mm²):	max. 1× 2.5, 2× 1.5/ max. 1× 2.5 (AWG 12)	
Dimensions:	90 × 17.6 × 64 mm (3.5" × 0.7" × 2.5")	
Weight:	55 g (1.95 oz)	
Standards:	EN 61812-1	

* Load can only be connected to AC voltage, see connection diagram 2.

Description

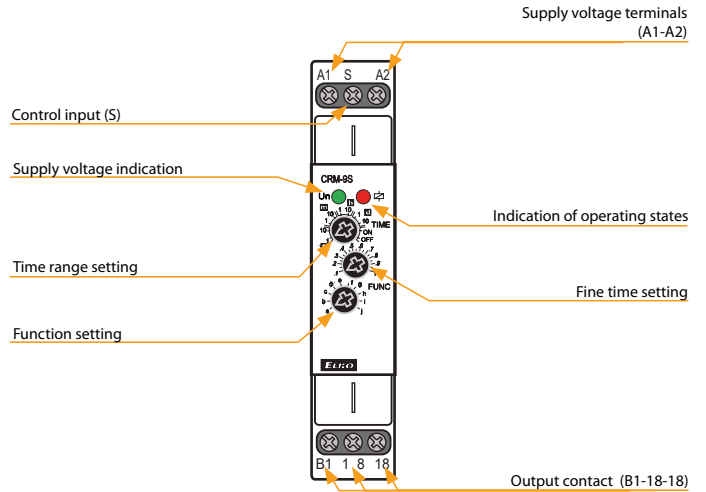

Connection

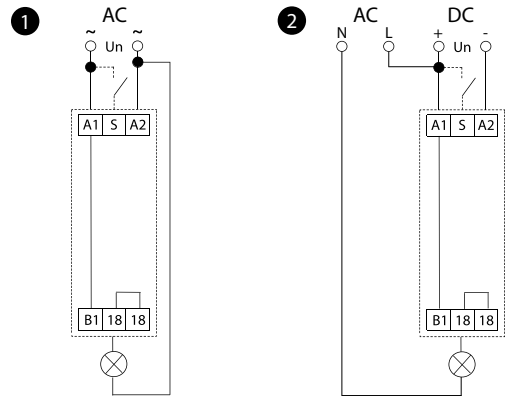

Possibility to connect load onto controlling input:

It is possible to connect the load (e.g.: contactor) between terminals S-A2, without any interruption of correct relay function.

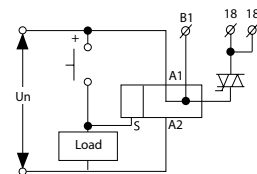

Indication of operating states

Signaling examples:



Function

Function (page 17).

Symbol

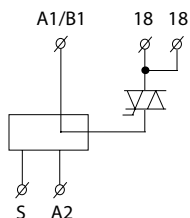

Function



ON DELAY
When the input voltage U is applied, timing delay t begins. Relay contacts R change state after time delay is complete. Contacts R return to their shelf state when input voltage U is removed. Trigger switch is not used in this function.



INTERVAL ON
When input voltage U is applied, relay contacts R change state immediately and timing cycle begins. When time delay is complete, contacts return to shelf state. When input voltage U is removed, contacts will also return to their shelfstate. Trigger switch is not used in this function.

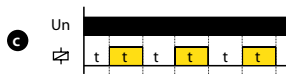

FLASHER - OFF first
When input voltage U is applied, time delay t begins. When time delay t is complete, relay contacts R change state for time delay t. This cycle will repeat until input voltage U is removed. Trigger switch is not used in this function.



FLASHER - ON first
When input voltage U is applied, relay contacts R change state immediately and time delay t begins. When time delay t is complete, contacts return to their shelf state for time delay t. This cycle will repeat until input voltage U is removed. Trigger switch is not used in this function.

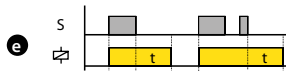

OFF DELAY
Input voltage U must be applied continuously. When trigger switch S is closed, relay contacts R change state. When trigger switch S is opened, delay t begins. When delay t is complete, contacts R return to their shelf state. If trigger switch S is closed before time delay t is complete, then time is reset. When trigger switch S is opened, the delay begins again, and relay contacts R remain in their energized state. If input voltage U is removed, relay contacts R return to their shelf state.

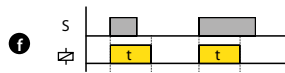

SINGLE SHOT
Upon application of input voltage U, the relay is ready to accept trigger signal S. Upon application of the trigger signal S, the relay contacts R transfer and the preset time t begins. During time-out, the trigger signal S is ignored. The relay resets by applying the trigger switch S when the relay is not energized.

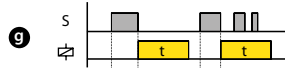

SINGLE SHOT falling edge
Upon application of input voltage U, the relay is ready to accept trigger signal S. Upon application of the trigger signal S, the relay contacts R transfer and the preset time t begins. At the end of the preset time t, the relay contacts R return to their normal condition unless the trigger switch S is opened and closed prior to time out t (before preset time elapses). Continuous cycling of the trigger switch S at a rate faster than the preset time will cause the relay contacts R to remain closed. If input voltage U is removed, relay contacts R return to their shelf state.

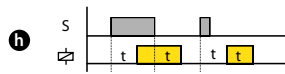

ON/OFF DELAY
Input voltage U must be applied continuously. When trigger switch S is closed, time delay t begins. When time delay t is complete, relay contacts R change state and remain transferred until trigger switch S is opened. If input voltage U is removed, relay contacts R return to their shelf state.

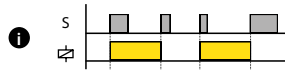

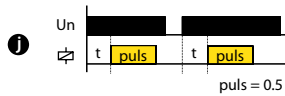

MEMORY LATCH
Input voltage U must be applied continuously. Output changes state with every trigger switch S closure. If input voltage U is removed, relay contacts R return to their shelf state.



PULSE GENERATOR
Upon application of input voltage U, a single output pulse of 0.5 seconds is delivered to relay after time delay t. Power must be removed and reapplied to repeat pulse. Trigger switch is not used in this function.

Looking for pricing, stock, or lifecycle information?

Click below to explore more details on WIN SOURCE:

-  [View CRM-9S on WIN SOURCE](#)
-  [ELKO EP North America LLC Information](#)

Optimize Your Supply Chain with WIN SOURCE Solutions

-  Global Sourcing Solution
-  Obsolete Management
-  Cost Control Management
-  Shortage Management
-  Alternative Solution
-  Excess Inventory Management